

Almería B/1/170/20

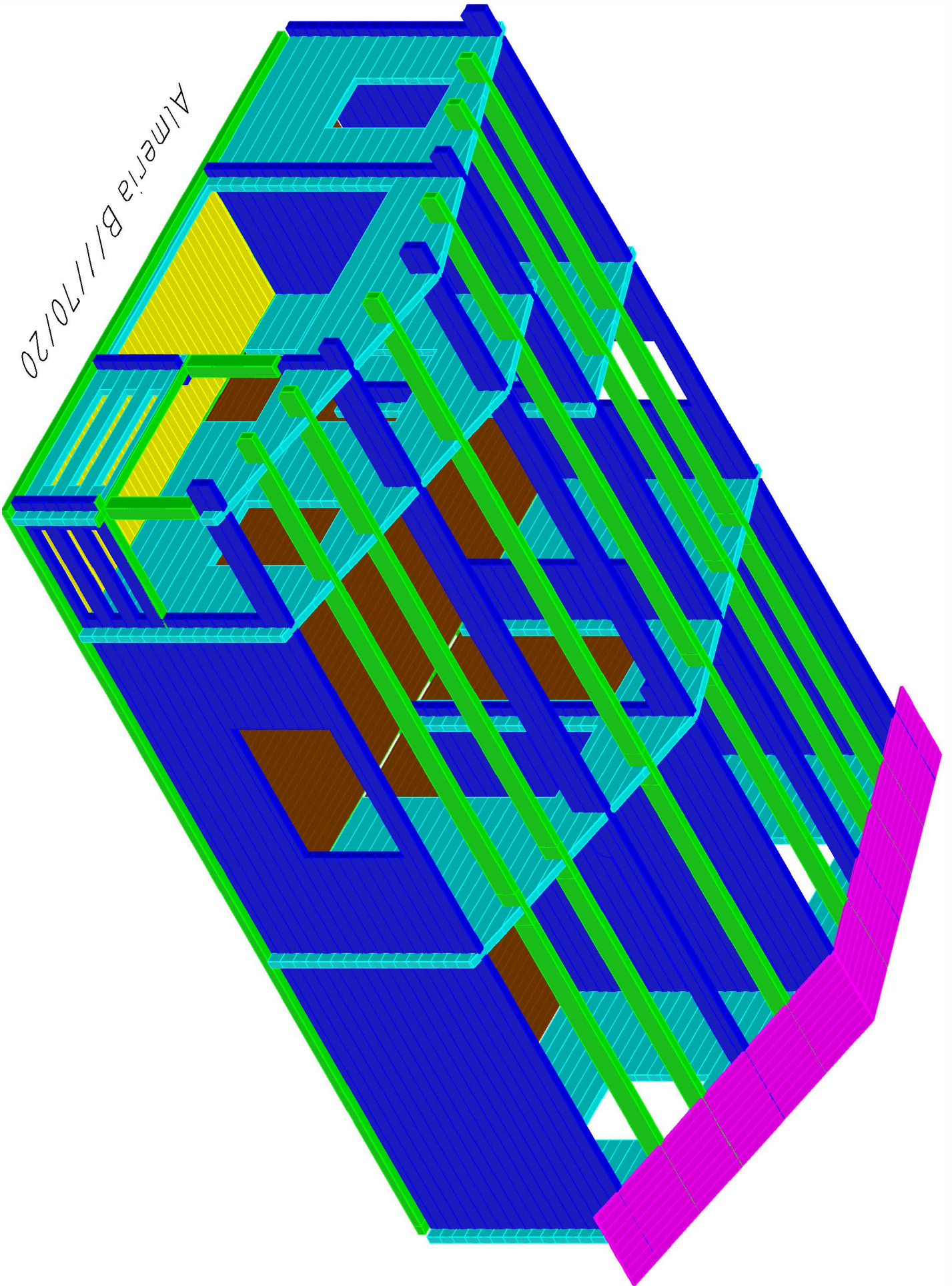

# Bismark B///70/20

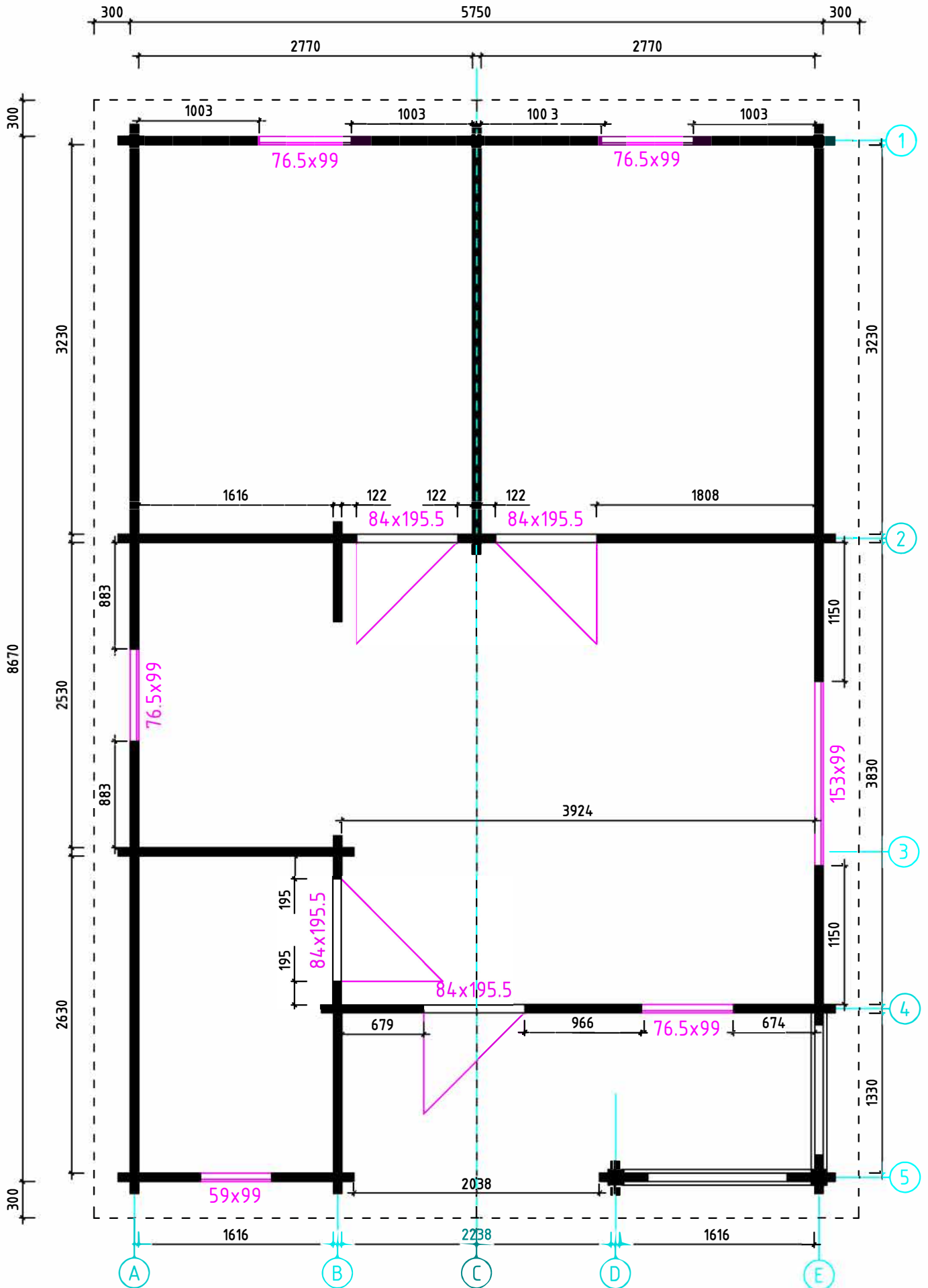

Grundplan

Bismark B///70/20

5740

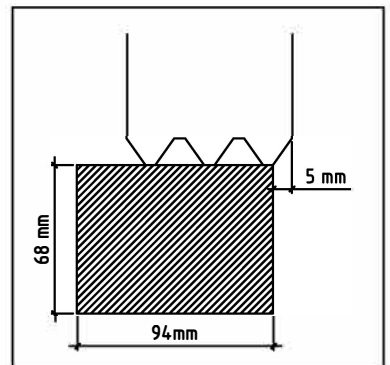
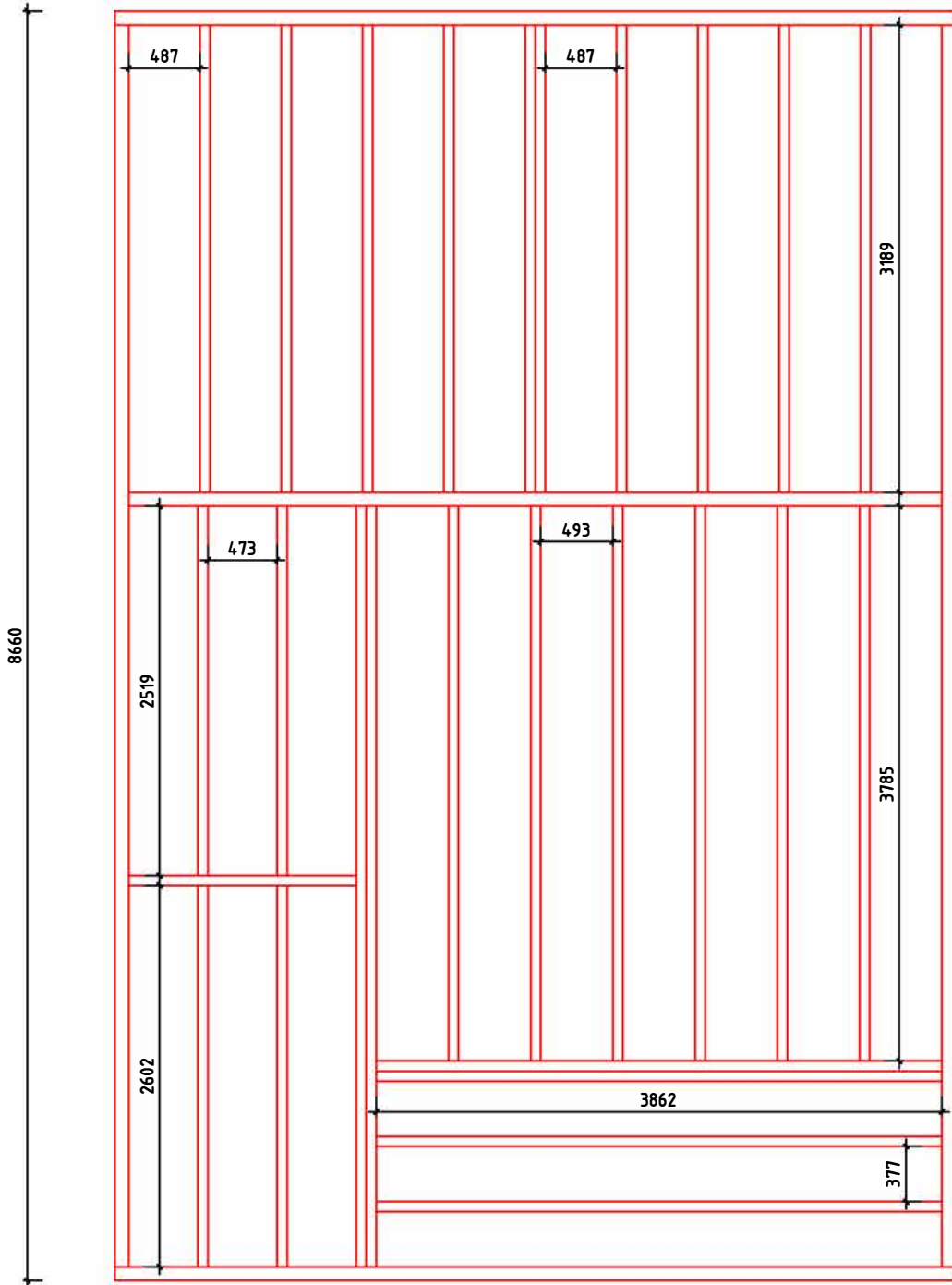

Fundament

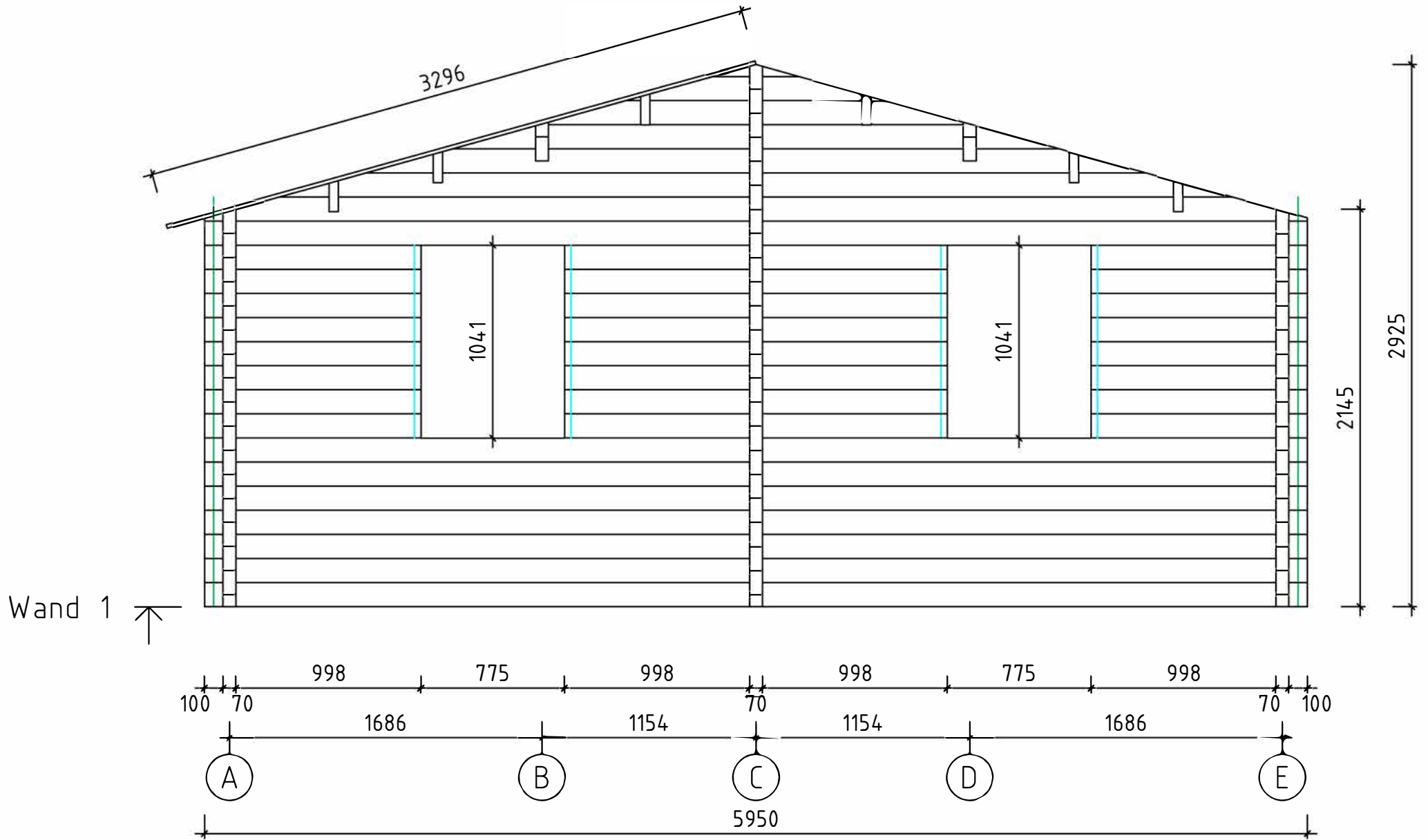

Bismark B///70/20

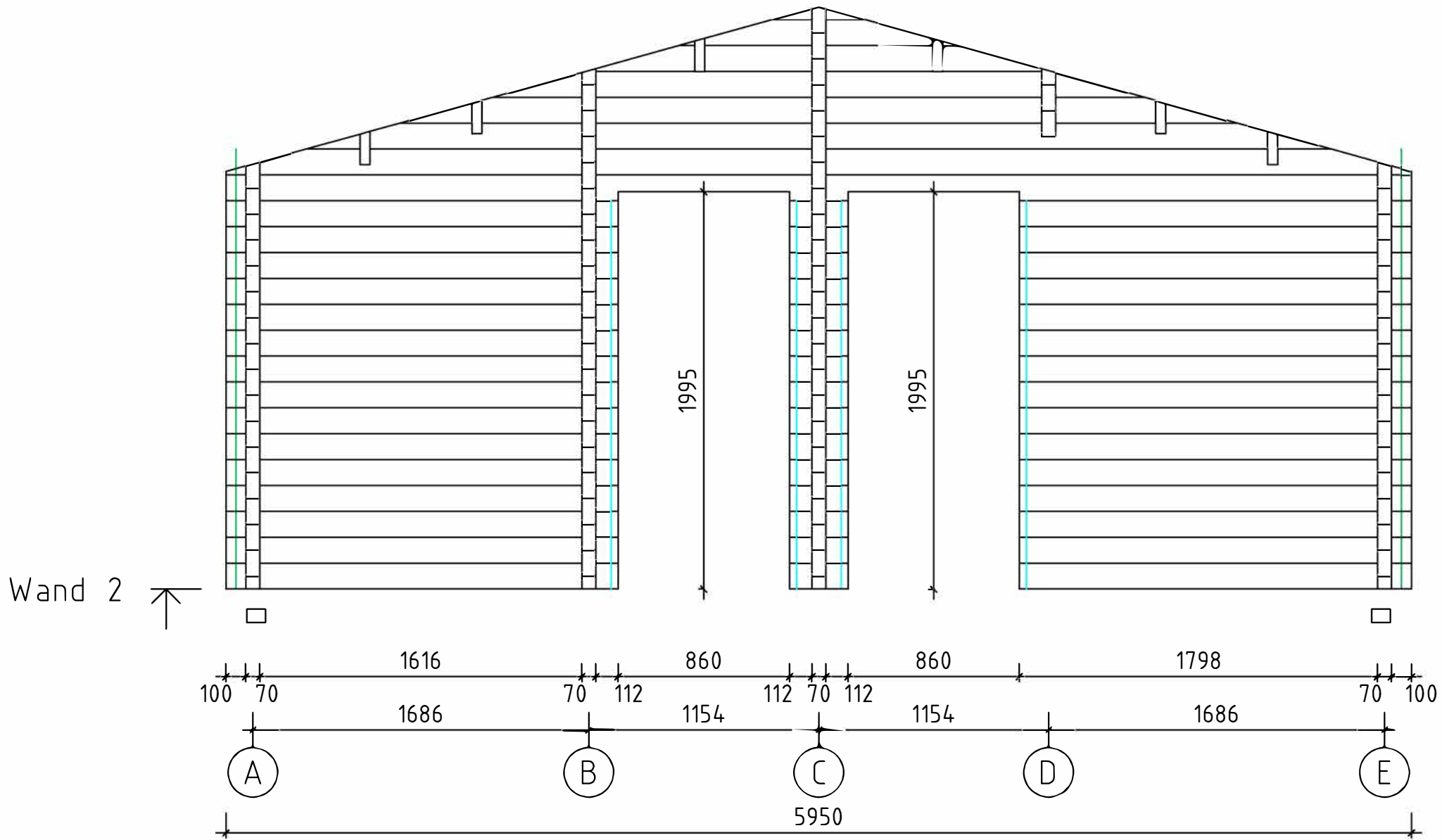

Bismarck B///70/20

Wand 3

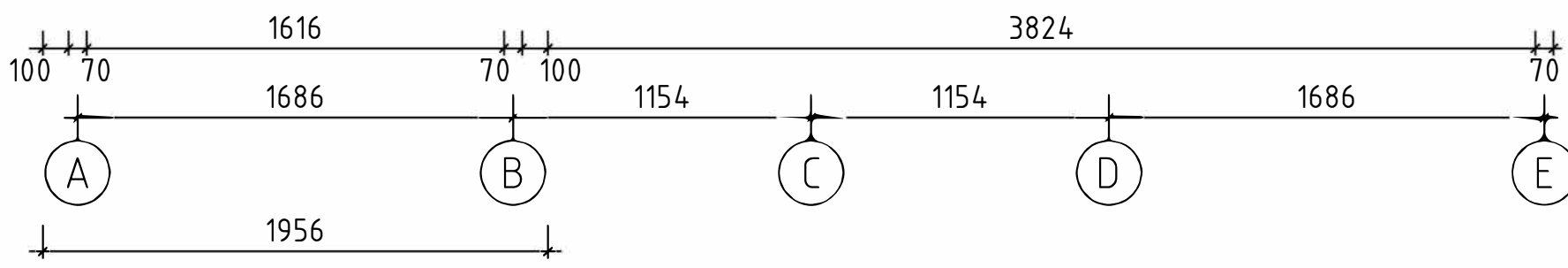
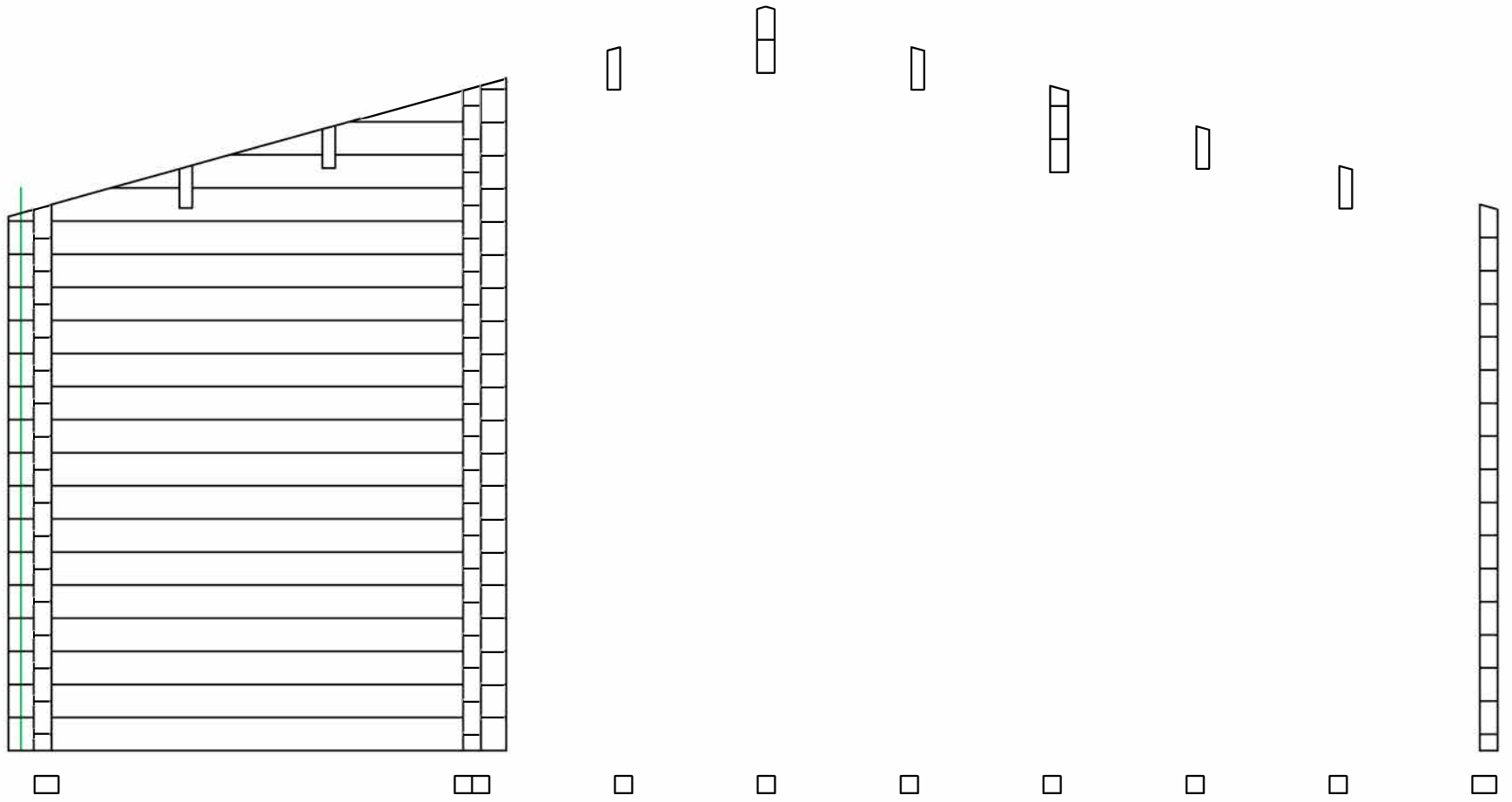

Bismark B///70/20

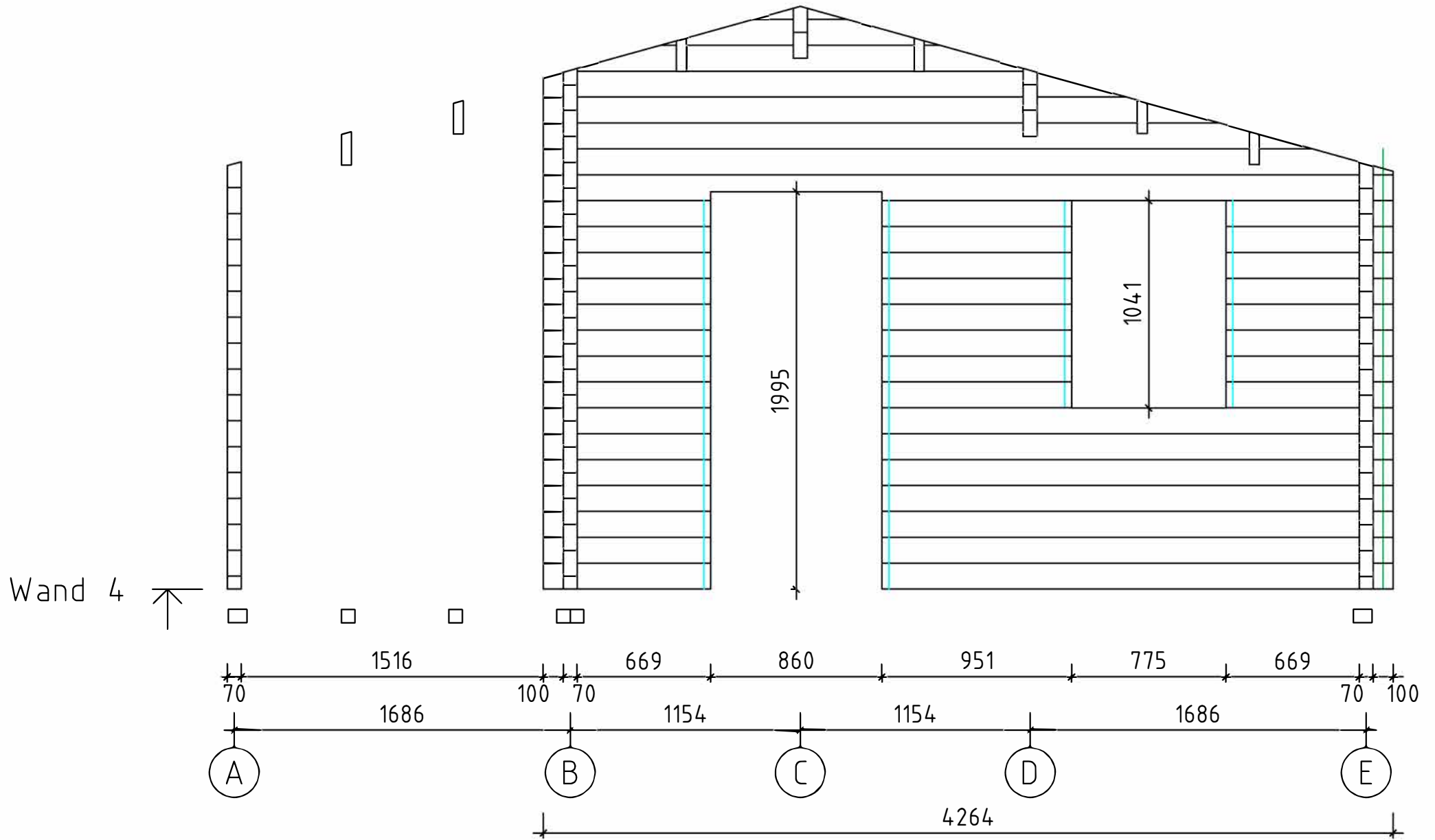

Bismark B///70/20

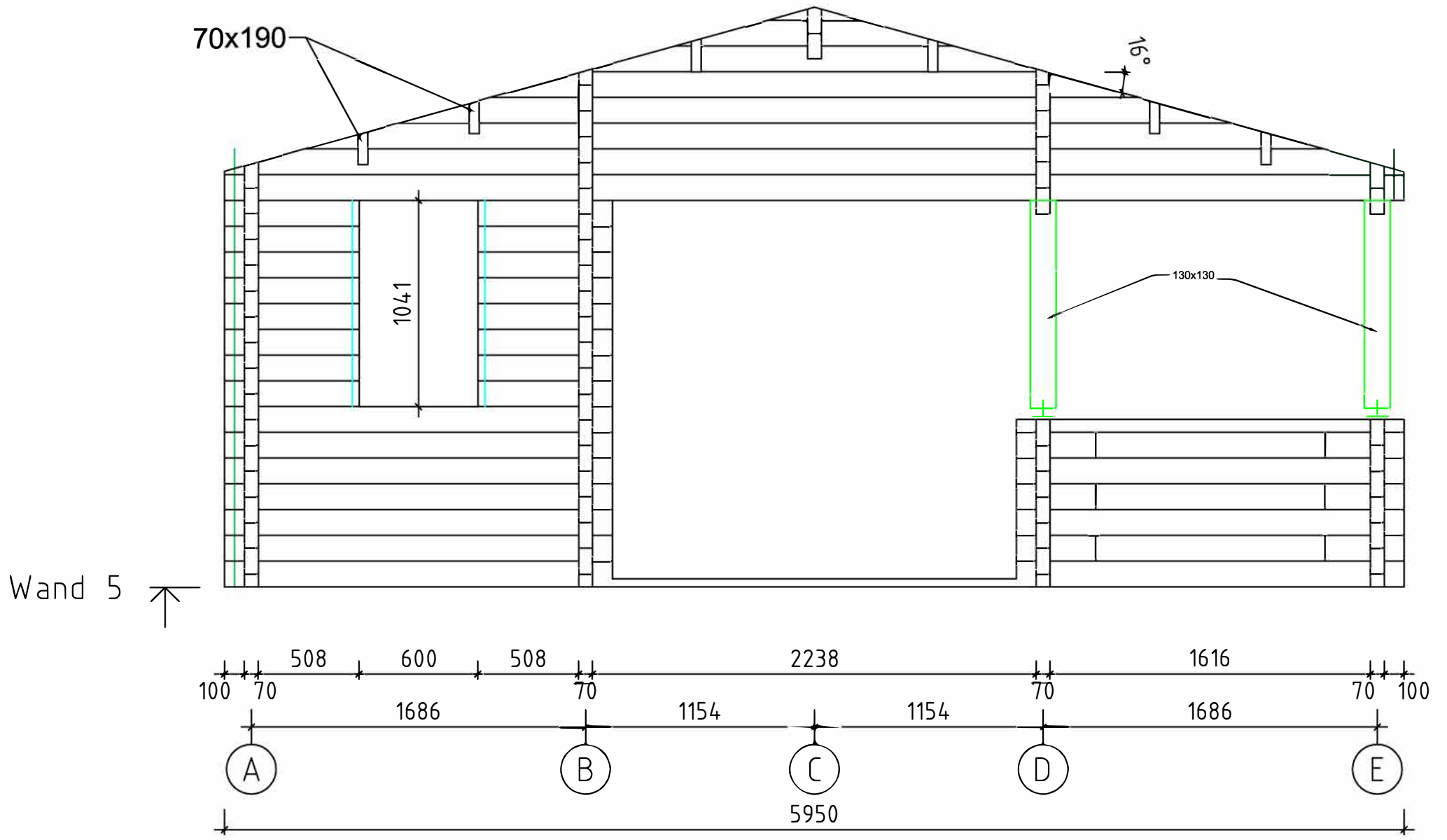

Bismark B///70/20

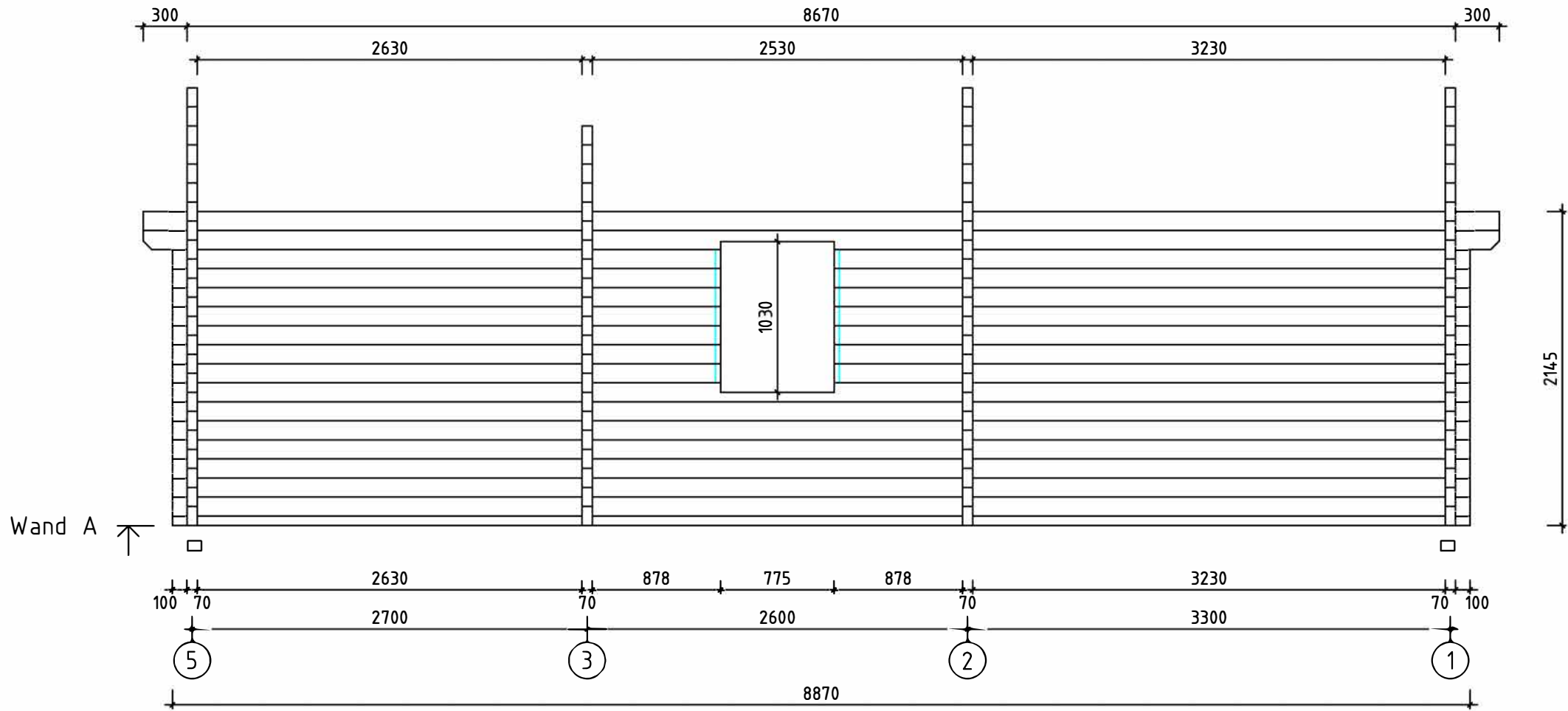

Bismark B///70/20

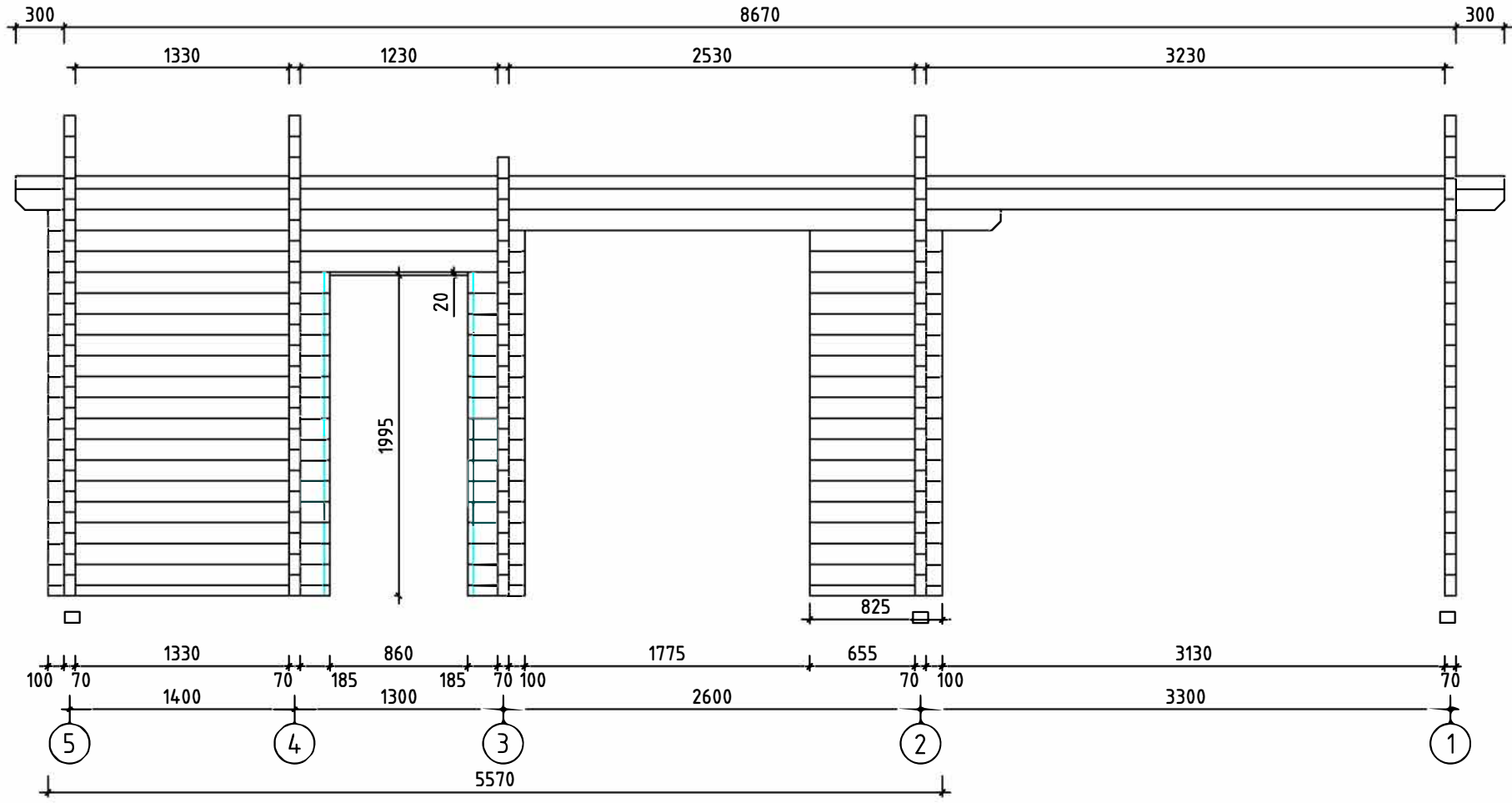

Wand B ↑

Bismark B///70/20

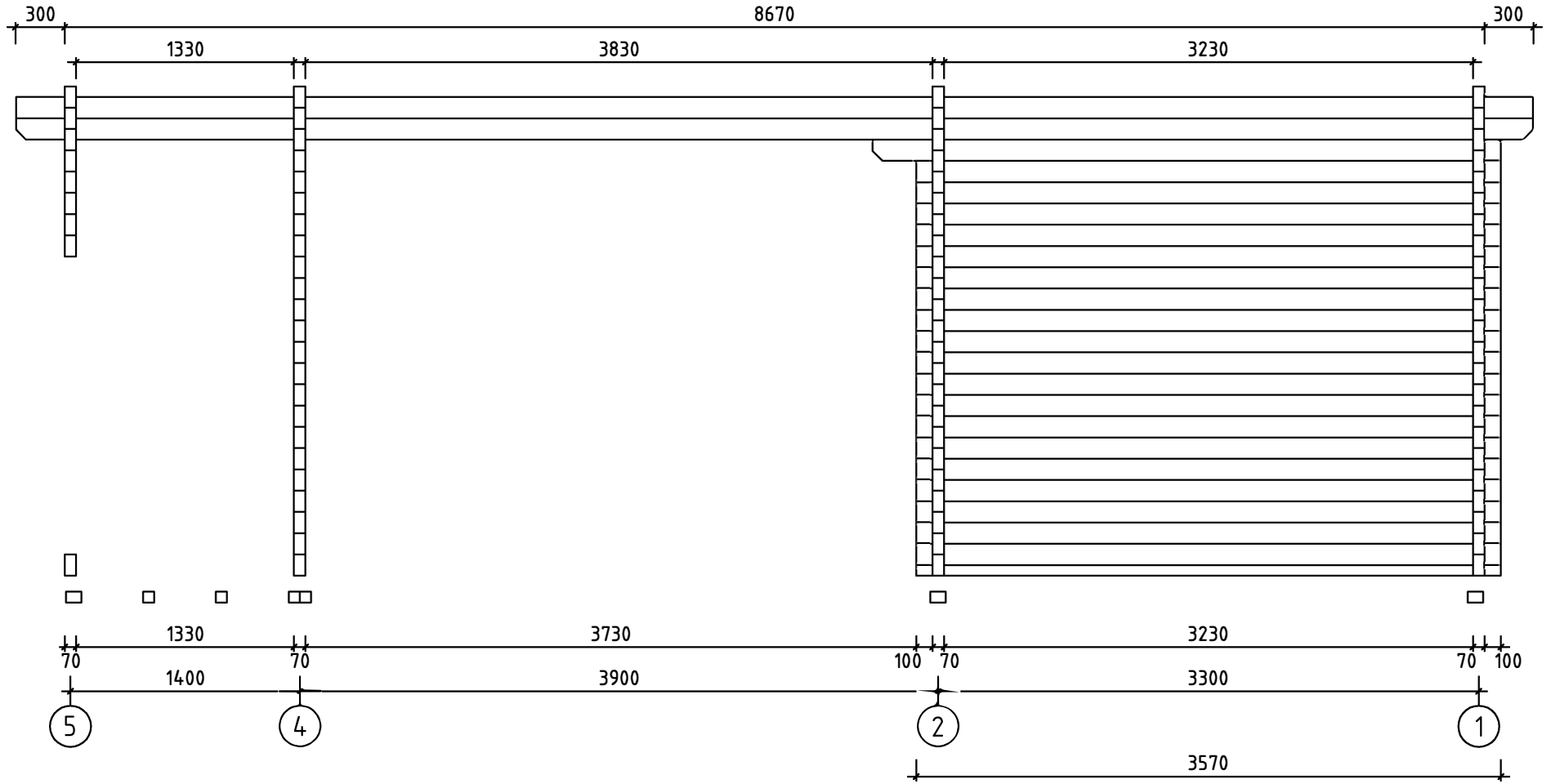

Wand C ↑

Bismark B///70/20

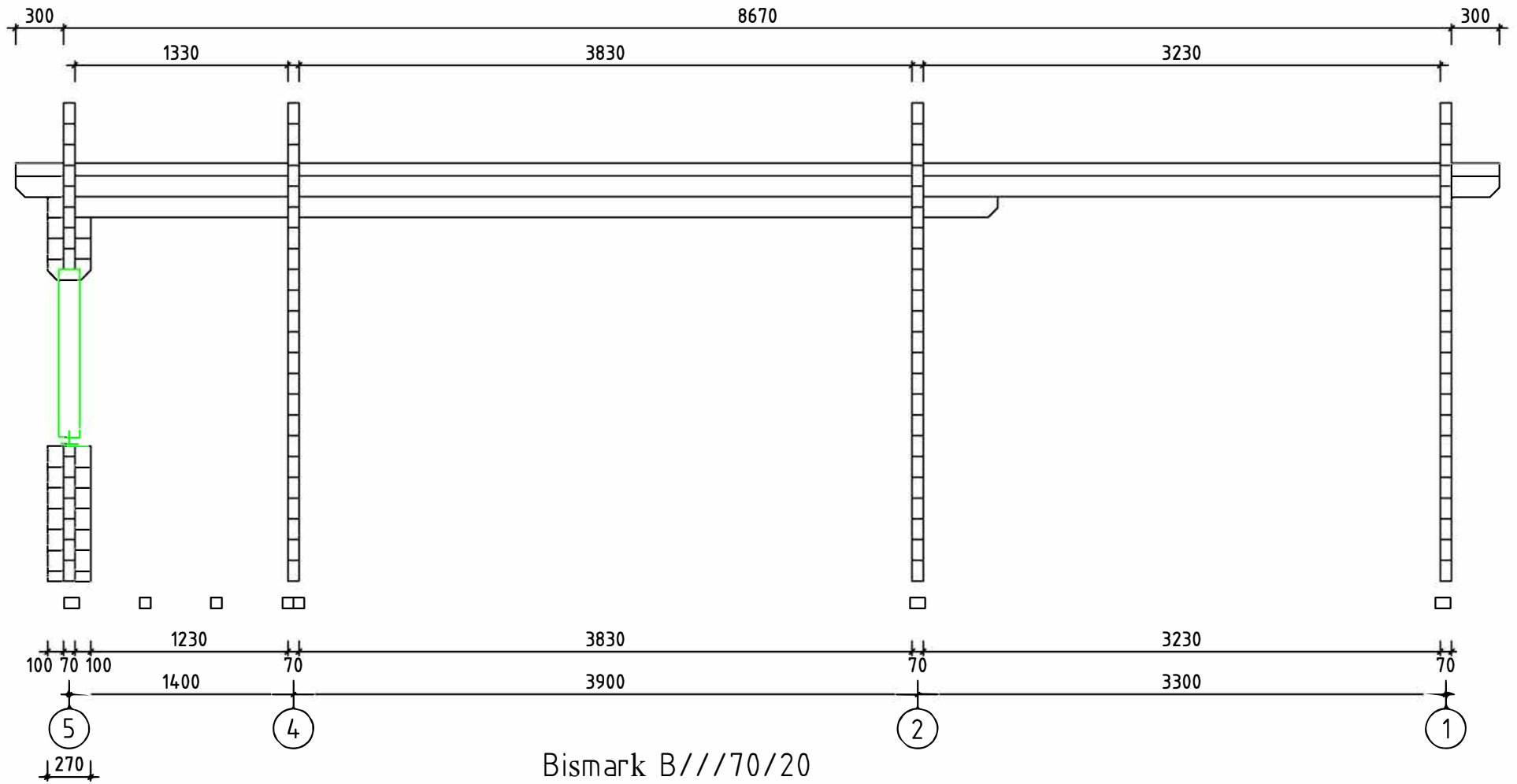

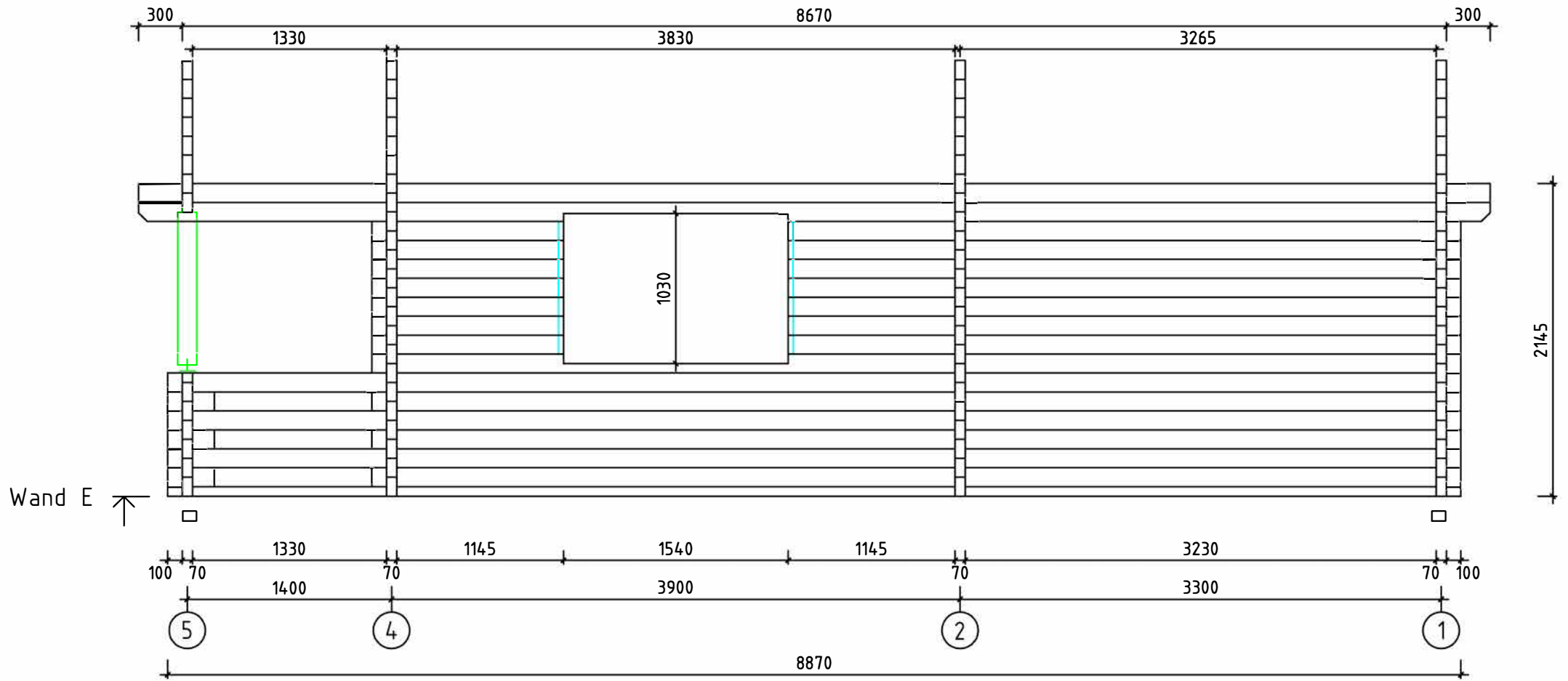

Bismark B///70/20

Bismark B///70/20

BC Fenster 1530x990 (Lengi mōõt!!)

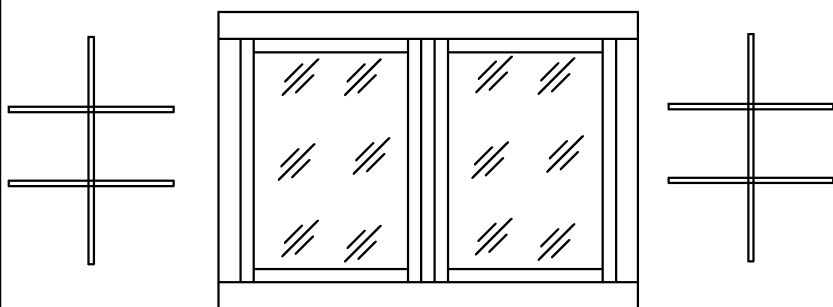

AB Tür 840x1955 (lengi mōõt)

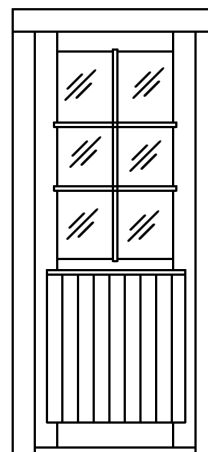

BC Fenster 765x990 (Lengi mōõt)

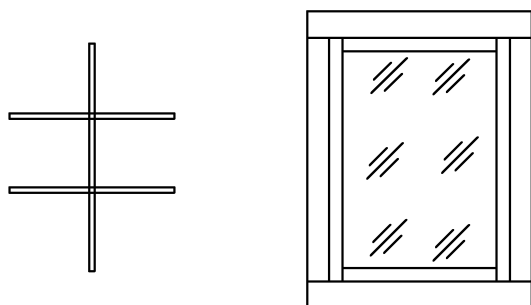

Tür 840x1955 (lengi mōõt)

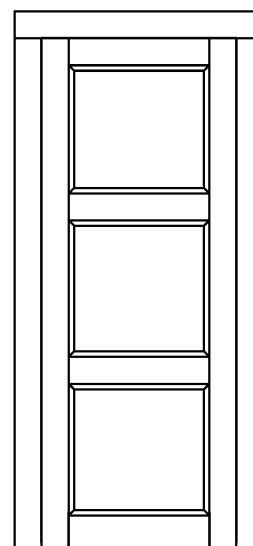

BC Fenster 590x990 (Lengi mōõt)

