

Nipissing Bunkie 2 40 (315x315)

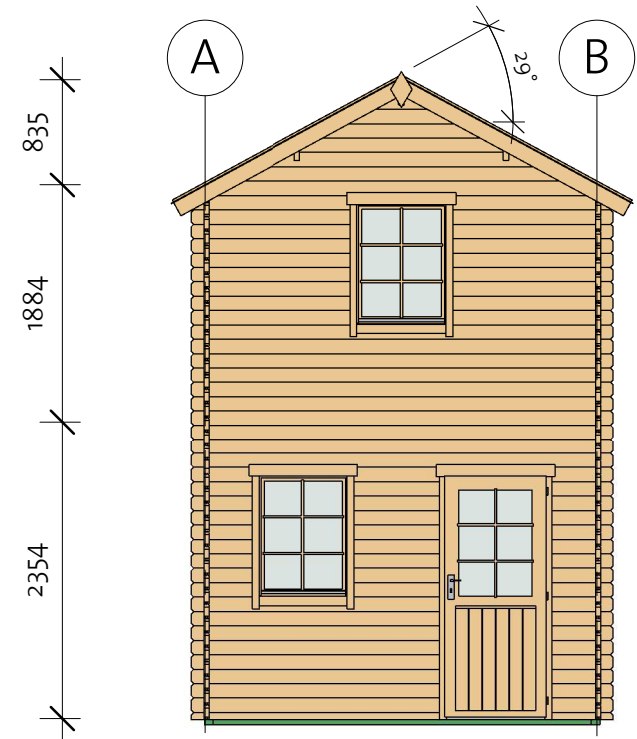
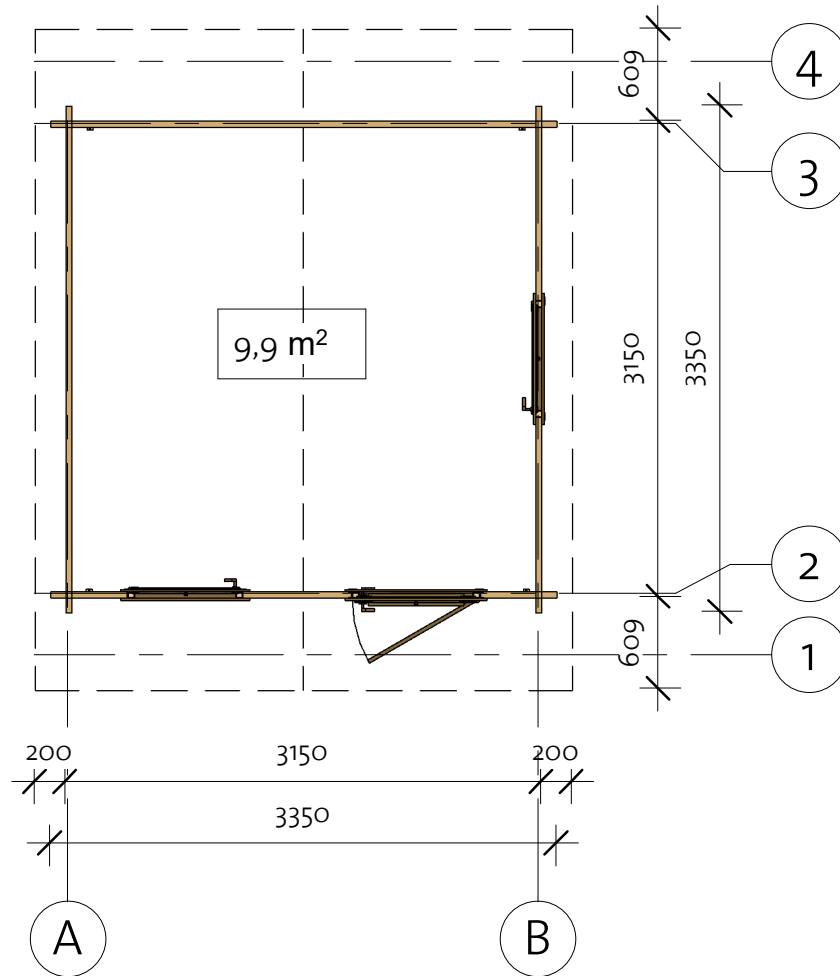

EZ Log Structures
Do-It-Yourself Building Kits

Nipissing Bunkie 2 40 (315x315)

Floor Plan

① Baseboard

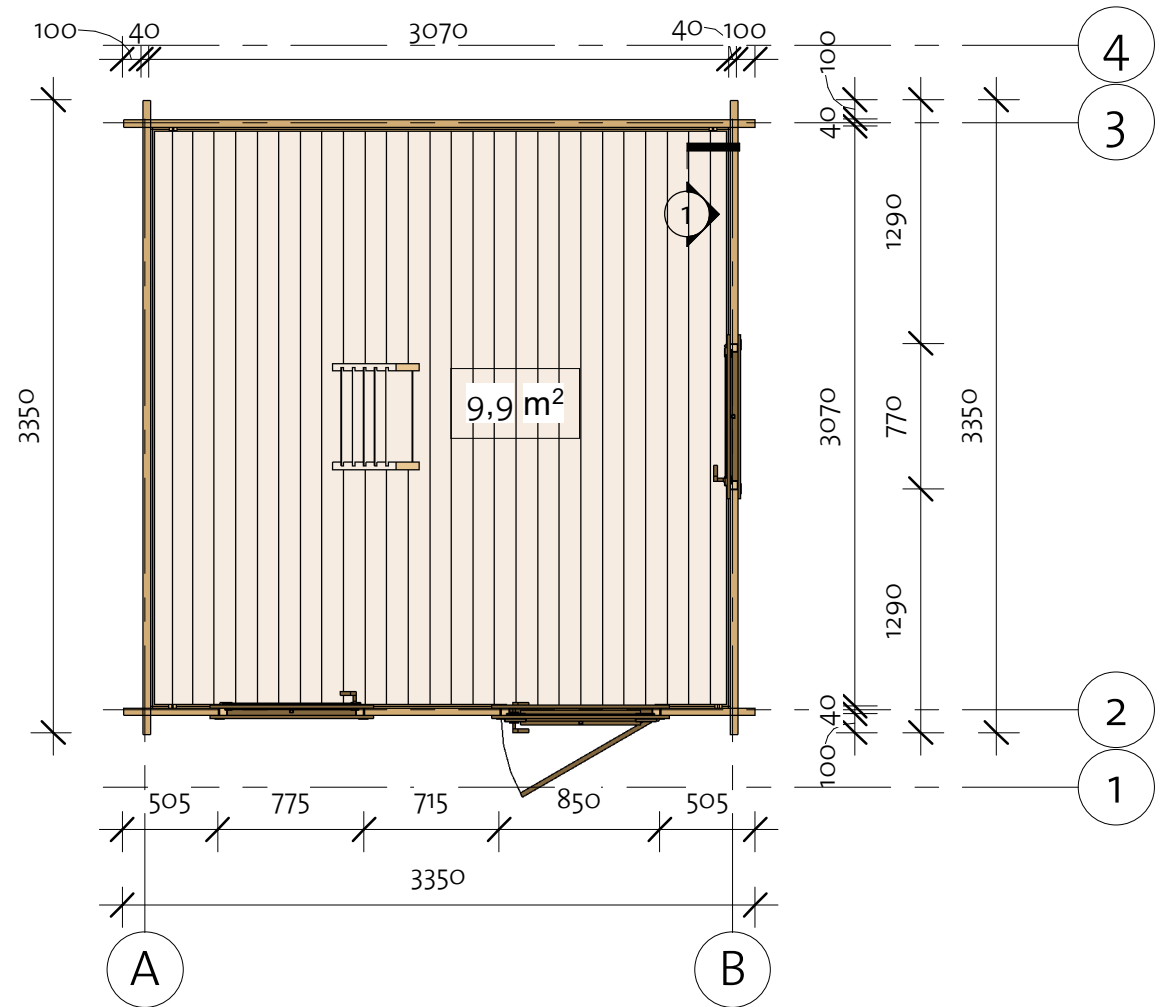
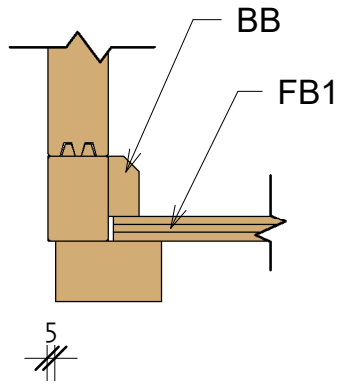

Floor Schedule

Mark	Type	Profile	Count	Length
FB1	FB 17x114		28	3064
BB1	BB 20x40		2	4000
BB2	BB 20x40		6	3200

Nipissing Bunkie 2 40 (315x315)

Wall 1

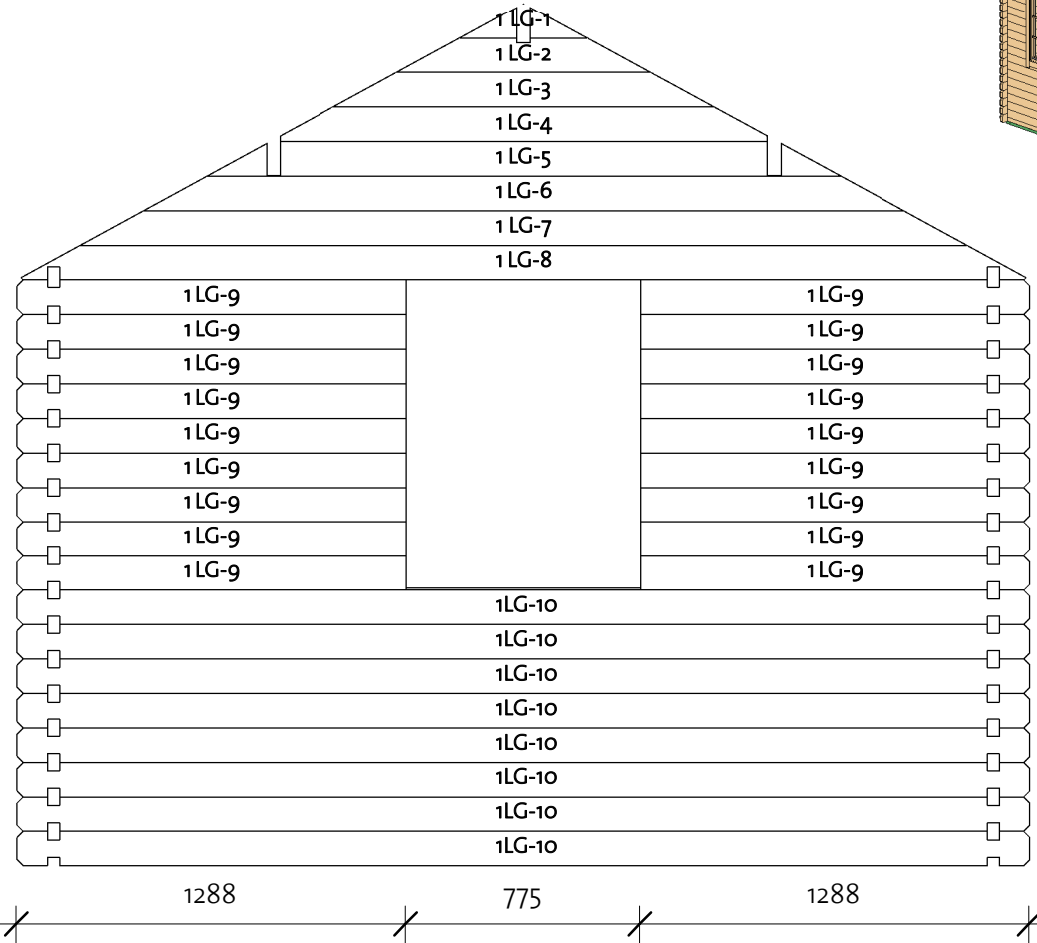
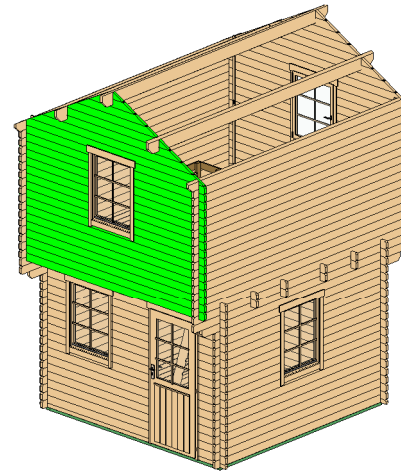

Wall 1			
Mark	Profile	Count	Cut Length

1LG-1 *	40X114	1	420
1LG-2 *	40X114	1	839
1LG-3 *	40X114	1	1258
1LG-4 *	40X114	1	1610
1LG-5 *	40X114	1	2096
1LG-6 *	40X114	1	2515
1LG-7 *	40X114	1	2934
1LG-8 *	40X114	1	3325
1LG-9	40X114	18	1288
1LG-10	40X114	8	3350

* Gable - delivered premounted

Log Profile Wall 1	
Profile	Profile

40X114	
--------	--

Nipissing Bunkie 2 40 (315x315)

Wall 4

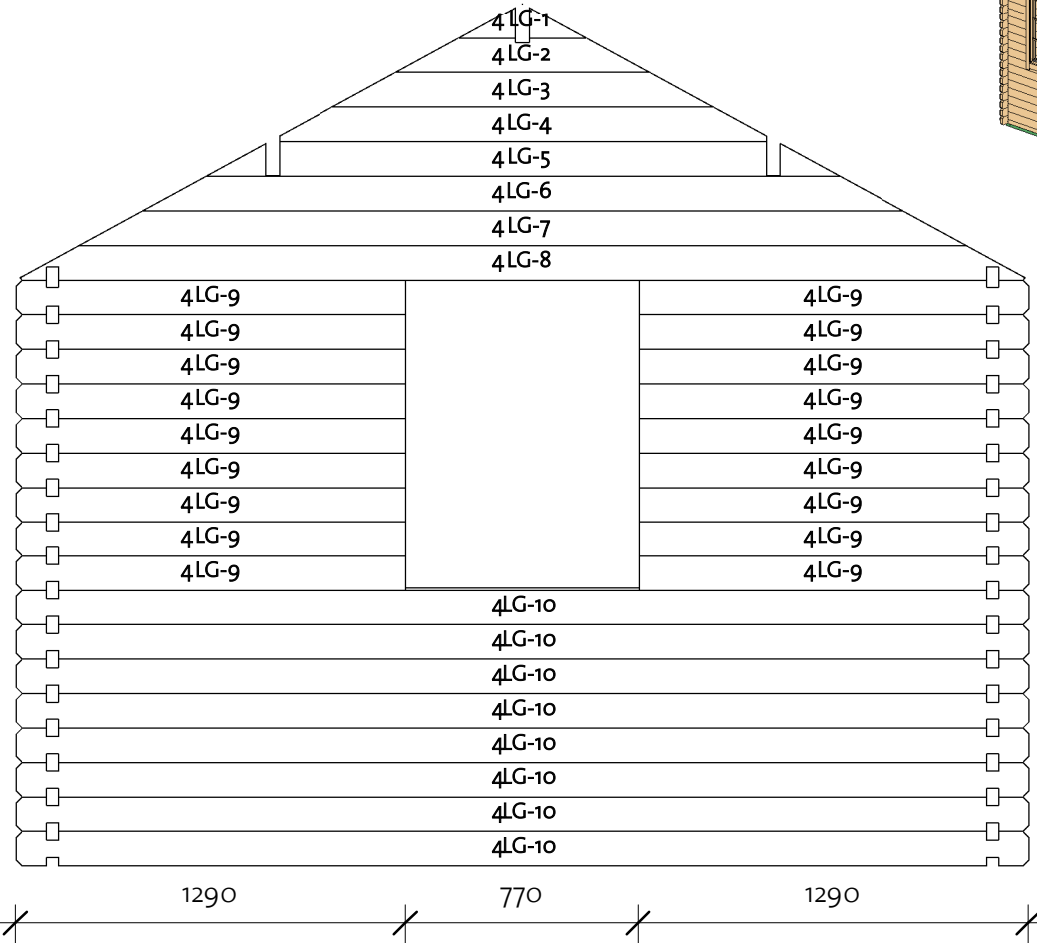
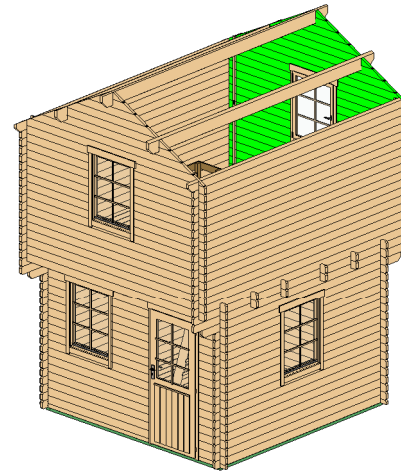

Wall 4			
Mark	Profile	Count	Cut Length

4LG-1 *	40X114	1	420
4LG-2 *	40X114	1	839
4LG-3 *	40X114	1	1258
4LG-4 *	40X114	1	1610
4LG-5 *	40X114	1	2096
4LG-6 *	40X114	1	2515
4LG-7 *	40X114	1	2934
4LG-8 *	40X114	1	3325
4LG-9	40X114	18	1290
4LG-10	40X114	8	3350

* Gable - delivered premounted

Log Profile Wall 4	
Profile	Profile

40X114	
--------	---

Nipissing Bunkie 2 40 (315x315)

Wall A

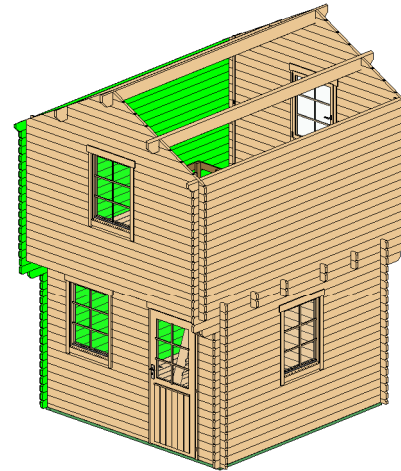
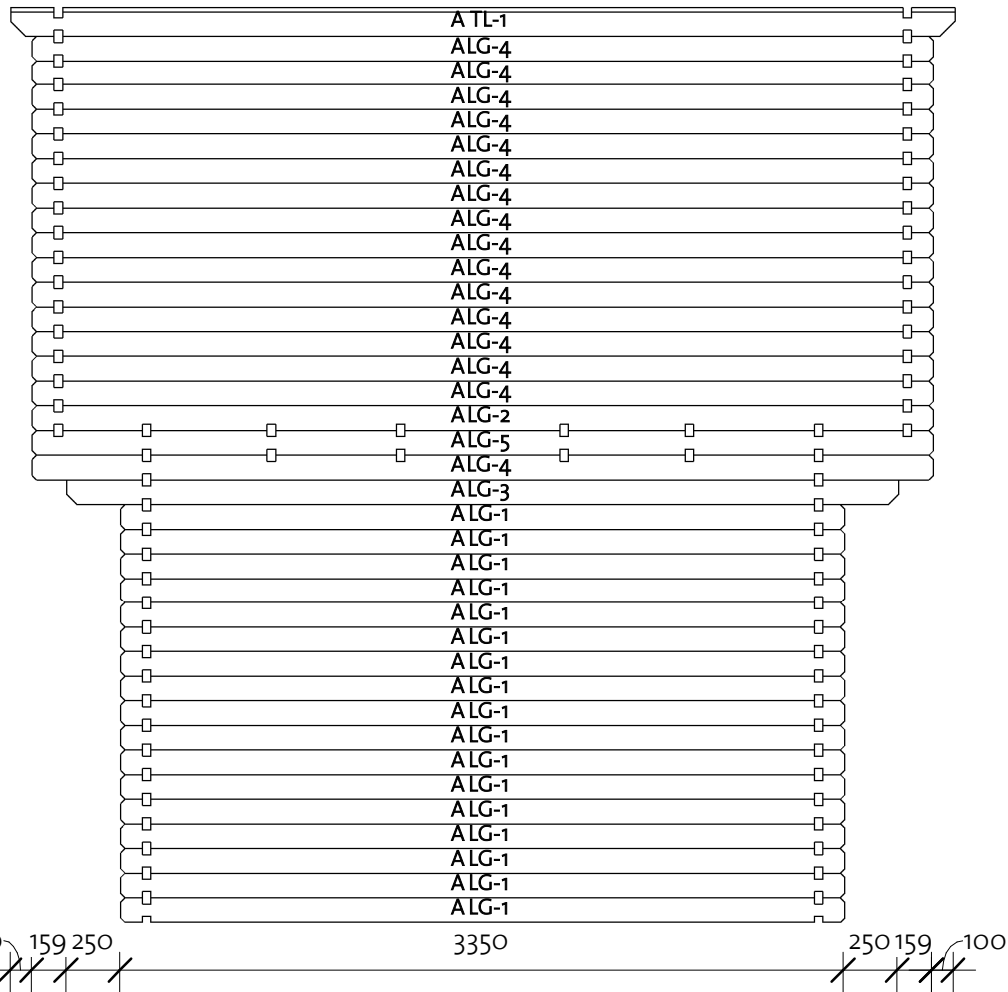

Wall A			
Mark	Profile	Count	Cut Length

ALG-1	40X114	17	3350
ALG-2	40X114	1	4168
ALG-3	40X114	1	3850
ALG-4	40X114	16	4168
ALG-5	40X114	1	4168
ATL-1	40X134	1	4368

Log Profile Wall A	
Profile	Profile

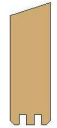
40X114	
40X134	

92102232_210611

Nipissing Bunkie 2 40 (315x315)

Wall B

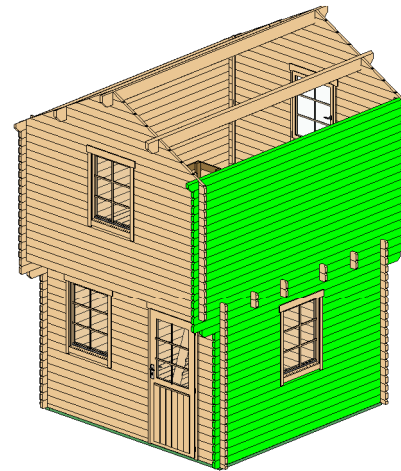
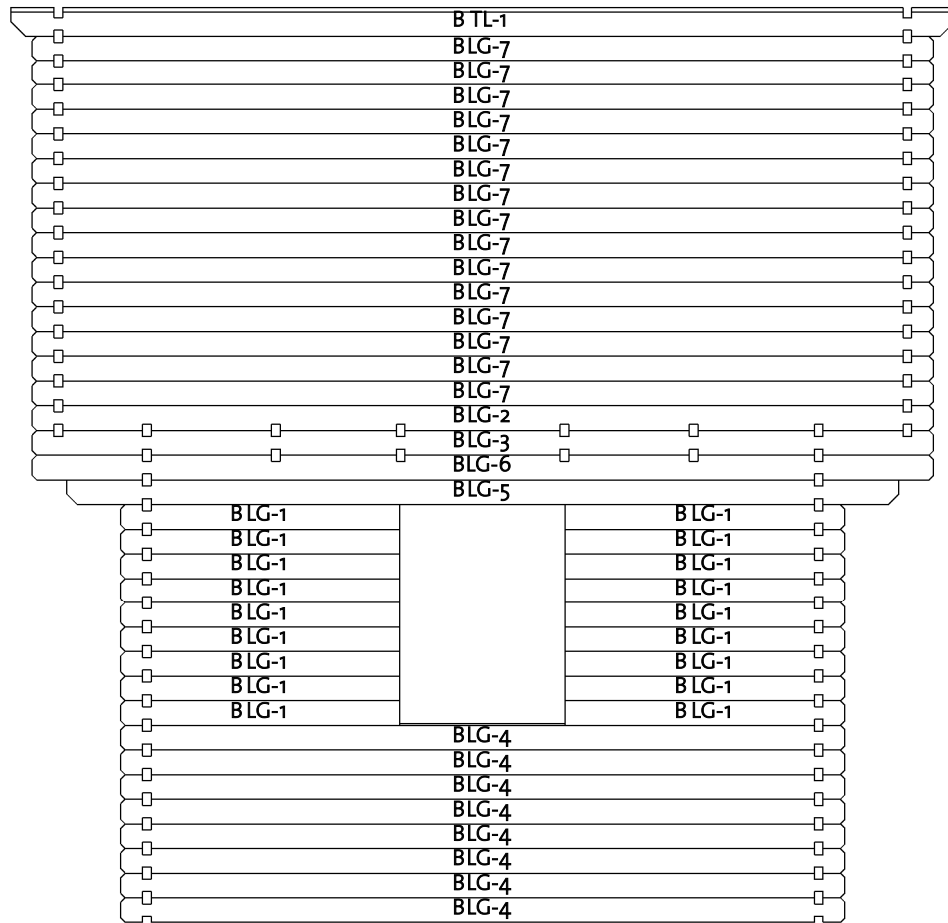

Wall B			
Mark	Profile	Count	Cut Length

BLG-1	40X114	18	1290
BLG-2	40X114	1	4168
BLG-3	40X114	1	4168
BLG-4	40X114	8	3350
BLG-5	40X114	1	3850
BLG-6	40X114	1	4168
BLG-7	40X114	15	4168
BTL-1	40X134	1	4368

Log Profile Wall B

Profile	Profile
---------	---------

40X134	
40X114	



100 159 250 1290 770 1290 250 159

92102232_210611

Nipissing Bunkie 2 40 (315x315)

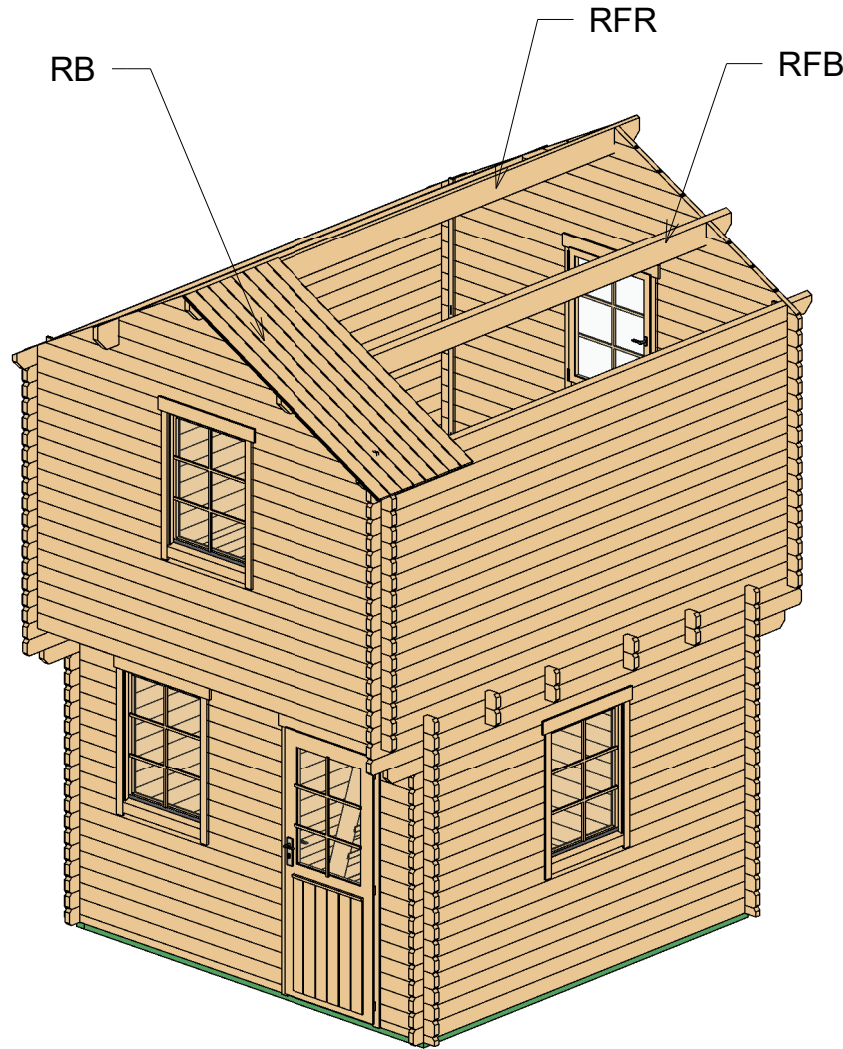
Roof 1



Roof				
Mark	Type	Profile	Count	Length
RFR	Ridge 45x195		1	4368
RFB	Beam 45x195		2	4368
RB	17x114		80	2012

Nipissing Bunkie 2 40 (315x315)

Roof 2

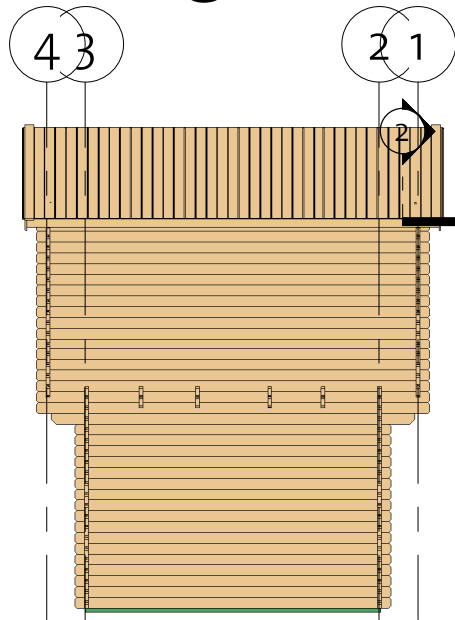

② Facia

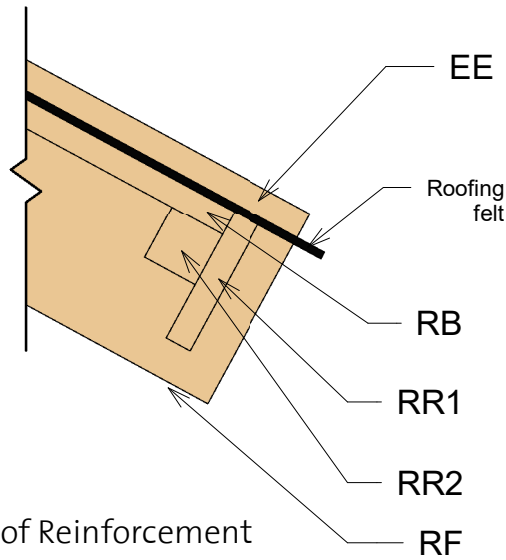

③ Roof Reinforcement

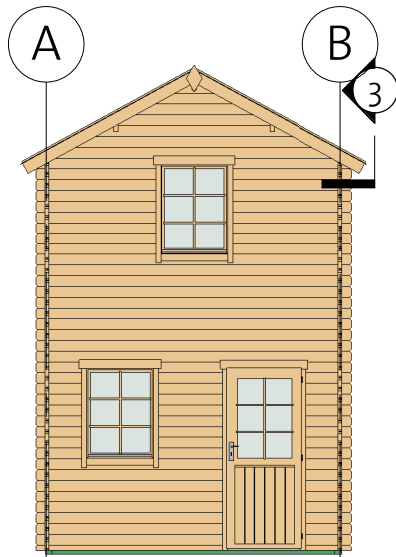
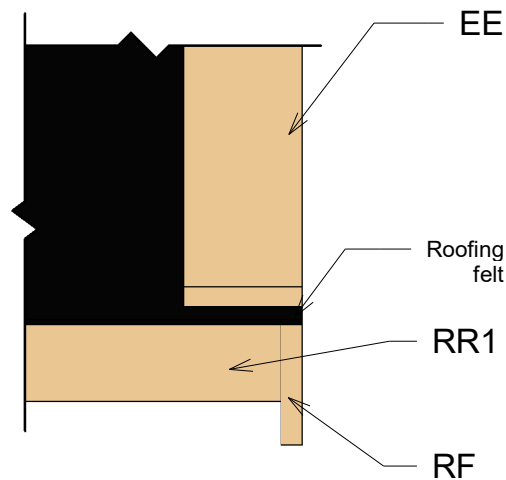

Fascia Schedule

Mark	Type	Profile	Count	Length
EE	Eave Edging 18x95		4	2066
RF	Roof Fascia 18x120		4	2066
RR1	Roof reinforcement 18x95		2	4368
RR2	Roof reinforcement 38x38		2	4368

Nipissing Bunkie 2 40 (315x315)

Second floor 12,5 m2

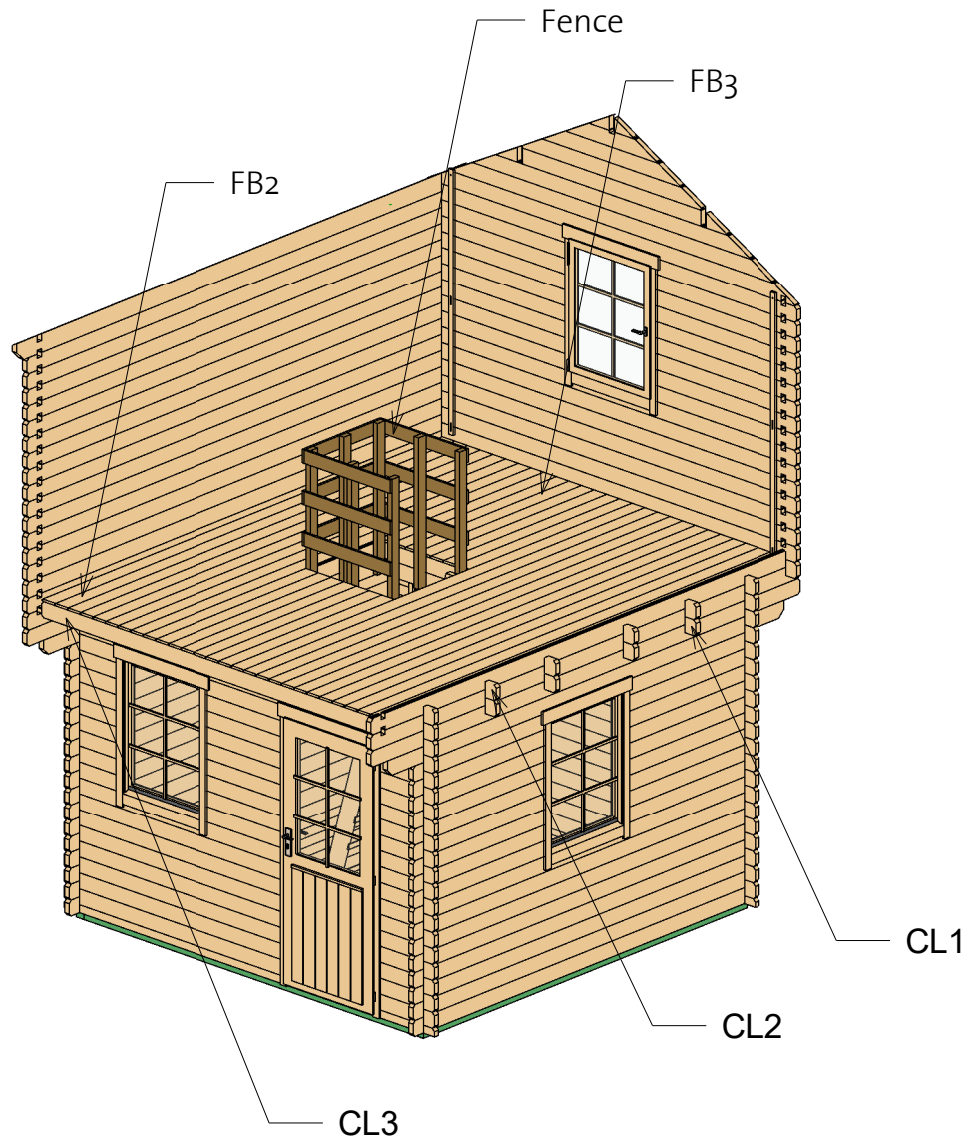

Second floor schedule				
Mark	Type	Profile	Length	Count
CL1	Log 40x114		3350	4
CL2	Log 40x114		3350	4
CL3	Log 40x114		3070	2

Second Floor Schedule				
Mark	Type	Profile	Count	Length
FB2	FB 17x114		21	3882
FB3	FB 17x114		14	1580

Nipissing Bunkie 2 40 (315x315)

Fence

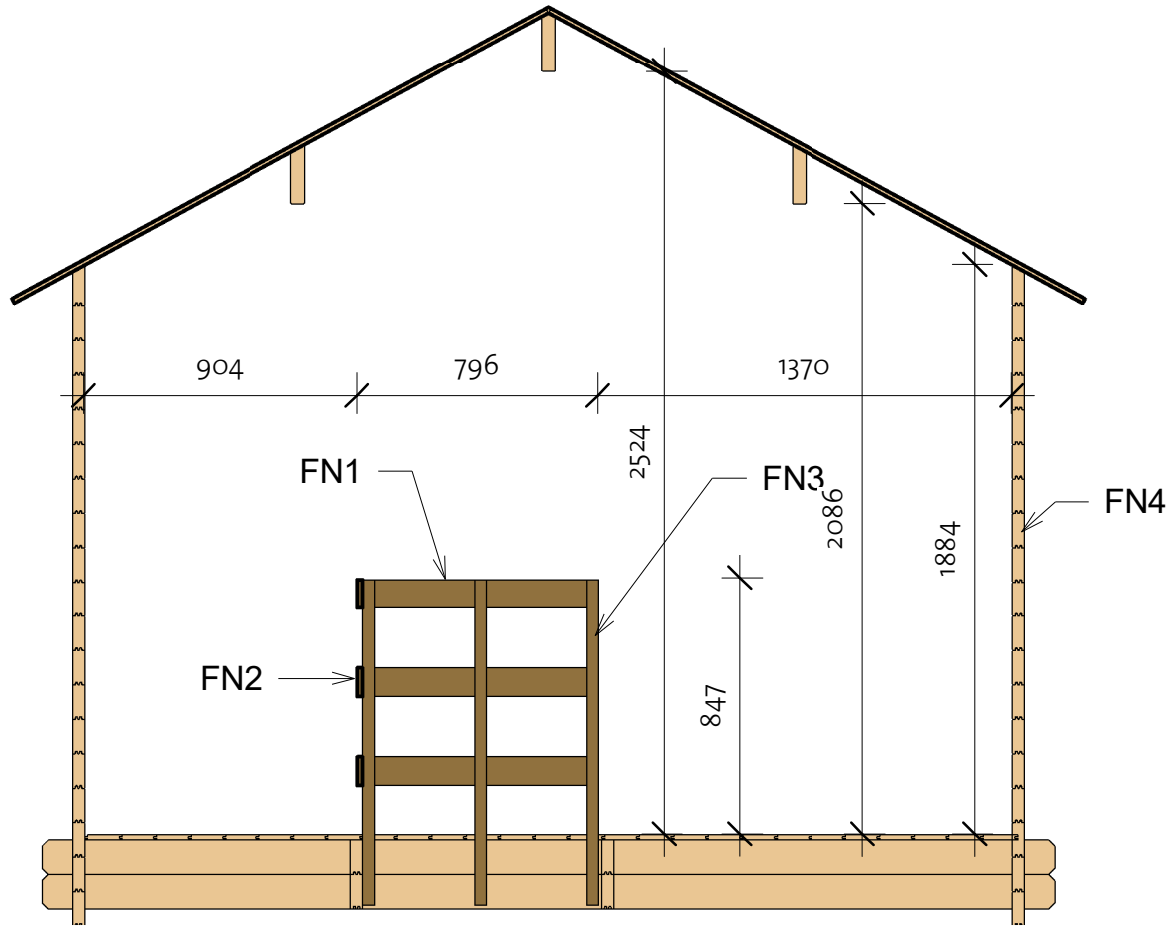

Fence schedule				
Mark	Type	Profile	Length	Count
FN1	Fence 18x95		778	6
FN2	Fence 18x95		758	3
FN3	Fence 40x70		1079	7

Nipissing Bunkie 2 40 (315x315)

Extras

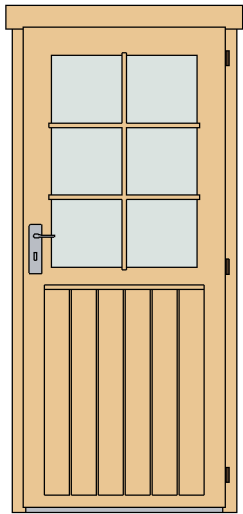

Door Schedule				
Model	Type	Width	Height	Count
CD4R	Classic door 4 right	840	1955	1
DCB6	Door Crossbar 6	--	--	1

Type	Count	Length
Windboard 18x40 2200	4	2200
Windboard 18x40x2300	4	2300

Type	Count
Romb	2



Fasteners/Extras		
Name	Type	Count

Hitblock	300-400 mm	
Ladder fittings		2
Bolts	M8 x 70	24
Screws	6,0 x 140	45
Nails	1,4 x 40	55
Screws	5,0 x 70	135
Screws	4,0 x 40	135
Screws	4,0 x 50	700

Window Schedule				
Mark	Type	Width	Height	Count
CW1L	Classic window 1 left	765	990	2
CW1R	Classic window 1 right	765	990	2
WCB6	Windows Crossbar 6	--	--	4

