

# Sleeping shelter 40 big (324x254)

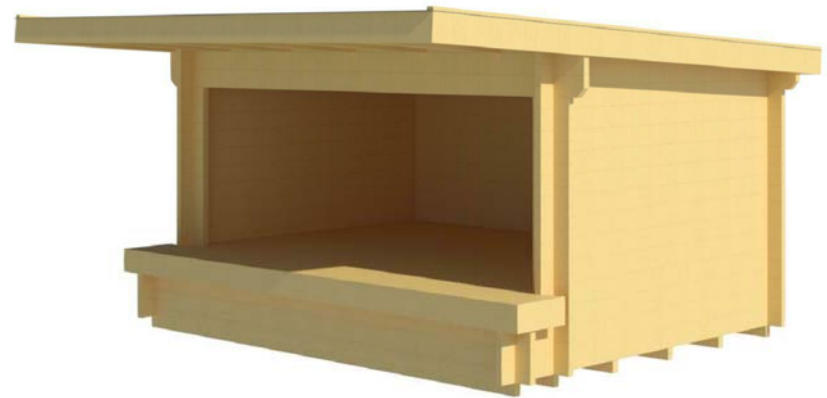

# Sleeping shelter 40 big (324x254)

Foundation

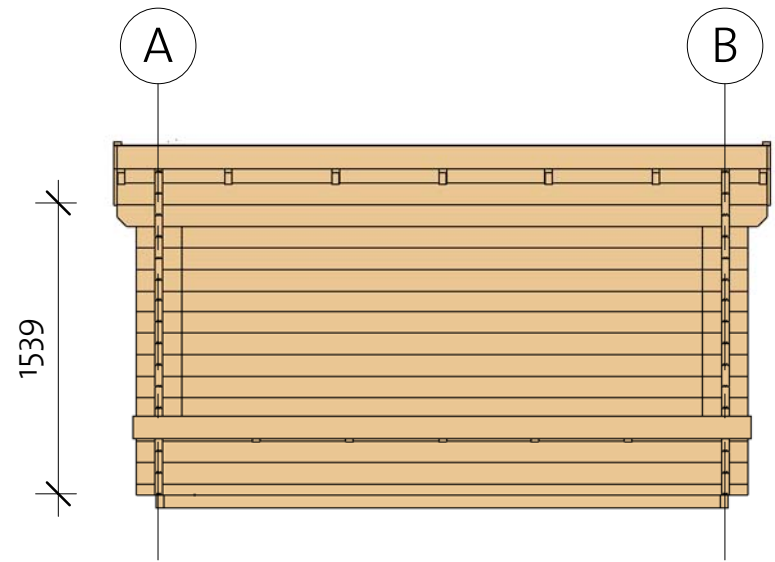
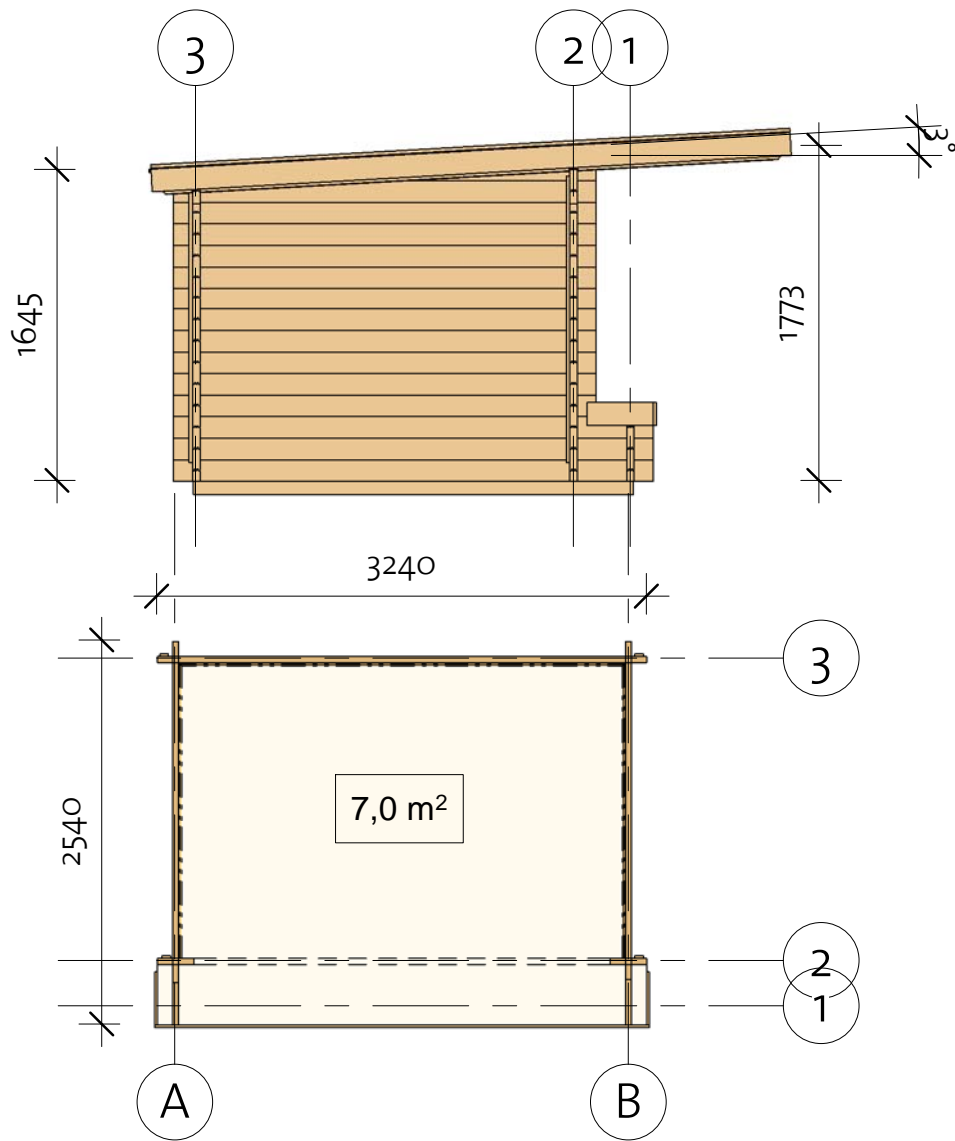
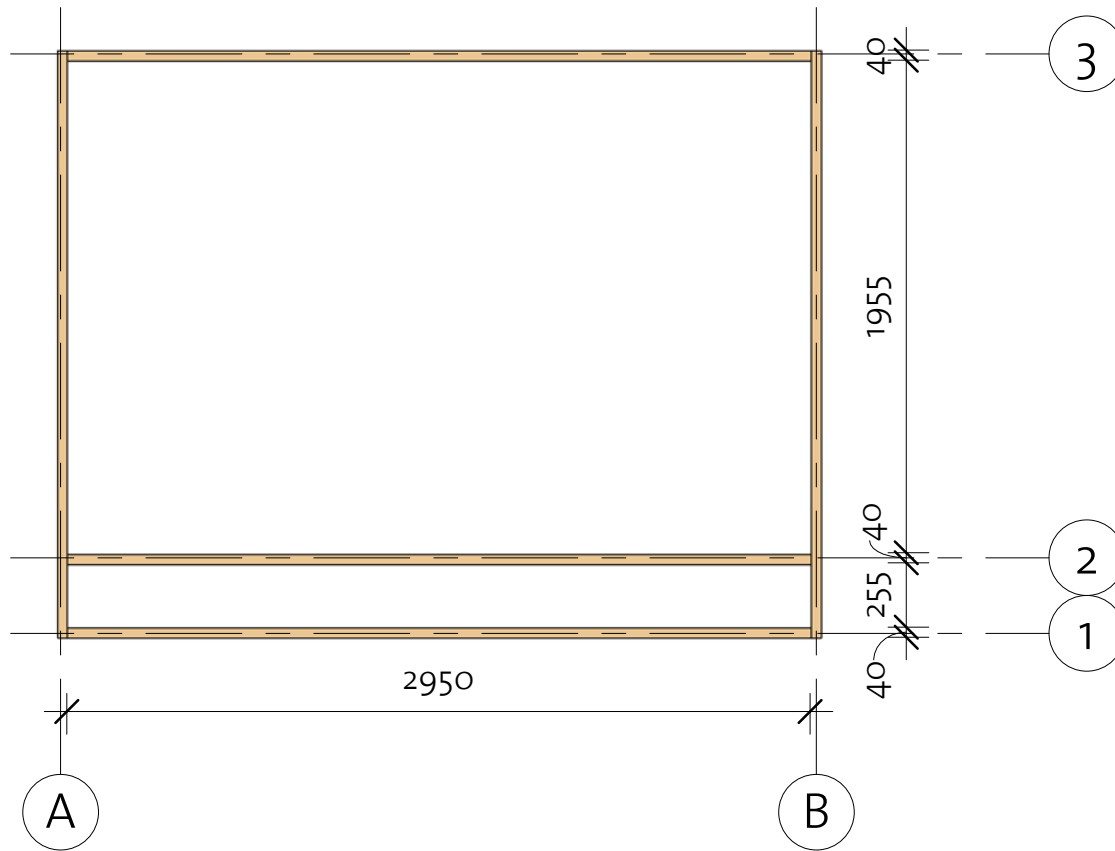

Impregnated foundation beams				
Mark	Type	Profile	Count	Length
IFB1	IFB 40x70		3	2950
IFB2	IFB 40x70		2	2330

# Sleeping shelter 40 big (324x254)

Floor Plan

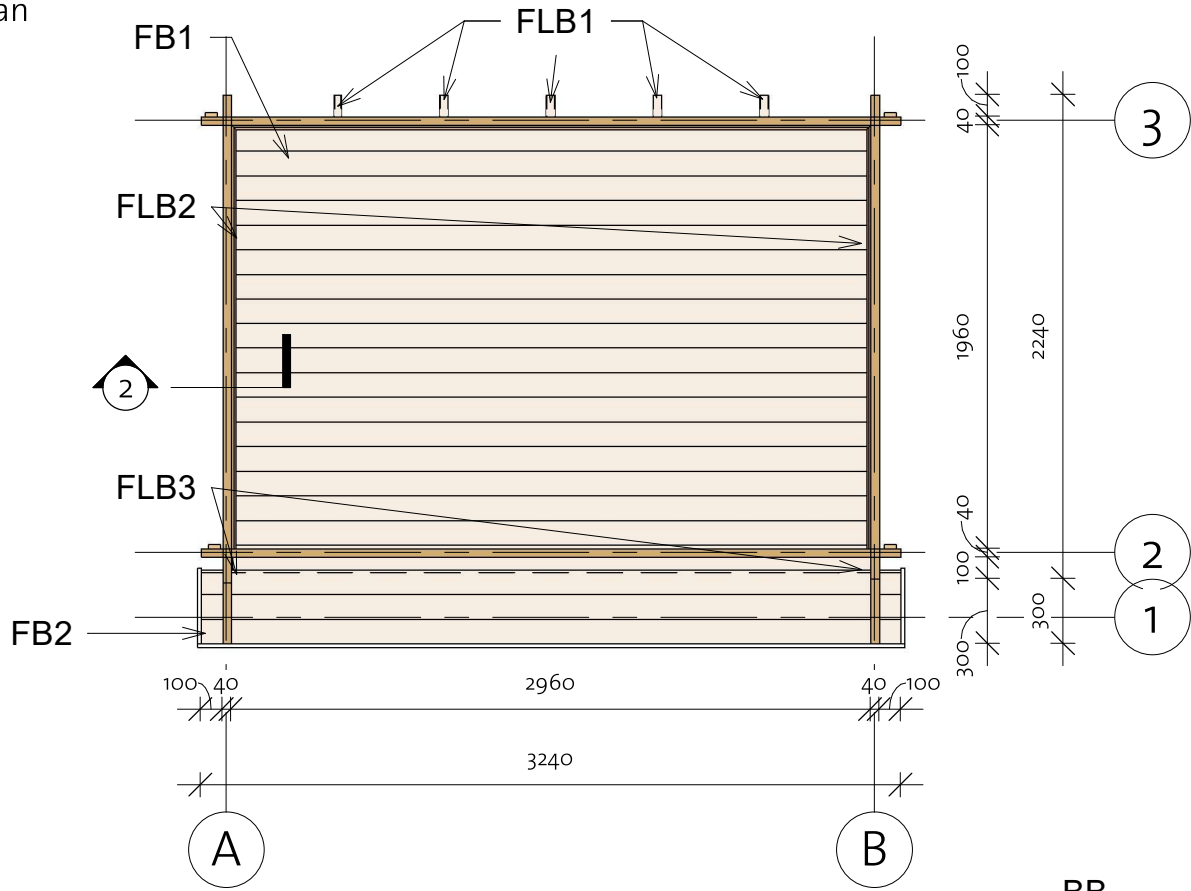

BB1	BB 20X40		1	3000
BB2	BB 20X40		2	2000

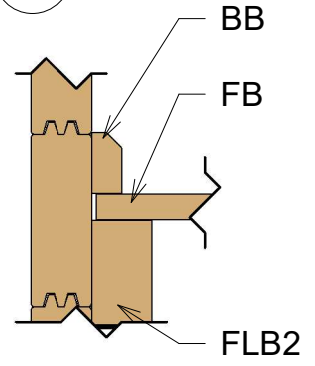

Floor Schedule

Mark	Type	Profile	Count	Length
FB1	FB 17x114		19	2957
FB2	FB 17x114		3	3240
FLB1	Floor beam 40X120		5	2540
FLB2	Floor beam 40X70		2	1960
FLB3	Floor beam 40X70		2	260

# Sleeping shelter 40 big (324x254)

Wall 1

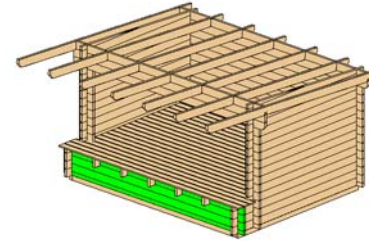

Wall 1			
Mark	Profile	Count	Cut Length

1BL-1	40X57	1	3240
1LG-1	40X114	2	3240
1TL-1	40X114	1	3240

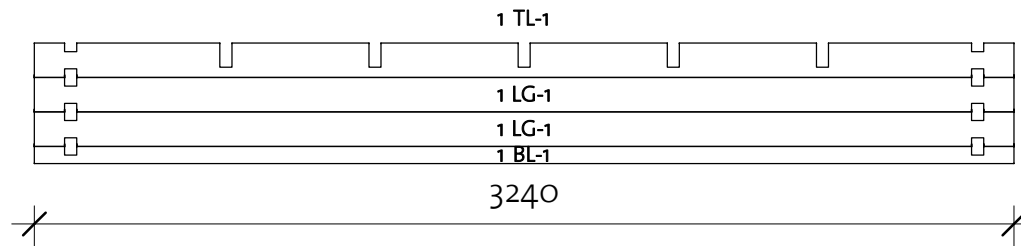

Log Profile Wall 1	
Profile	Profile

40X57	
40X114	
40X114	

# Sleeping shelter 40 big (324x254)

Wall 2

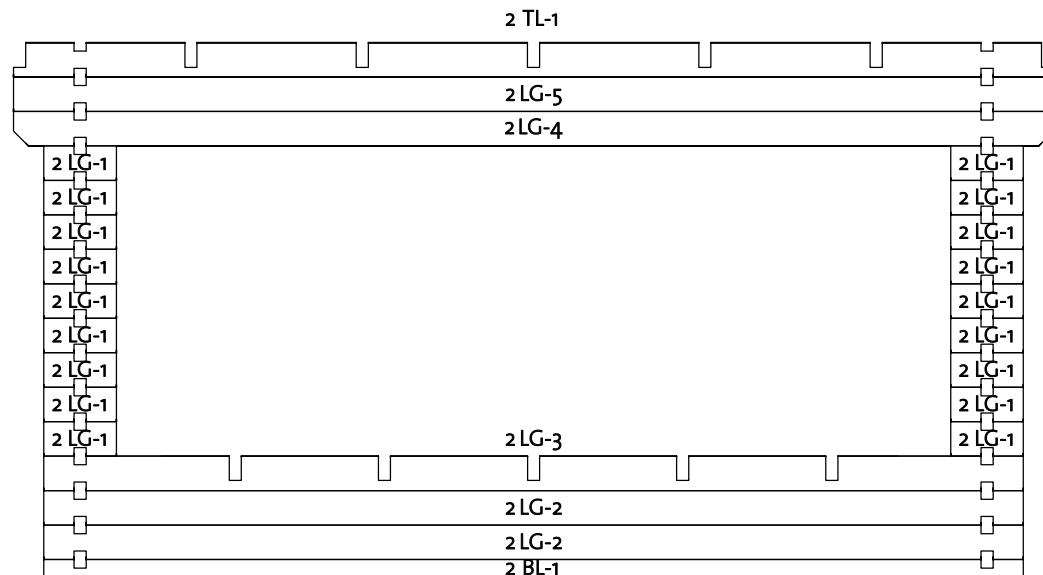
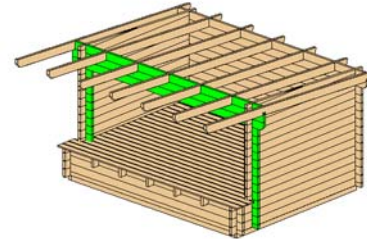

Wall 2			
Mark	Profile	Count	Cut Length

2BL-1	40X57	1	3240
2LG-1	40X114	18	240
2LG-2	40X114	2	3240
2LG-3	40X114	1	3240
2LG-4	40X114	1	3440
2LG-5	40X114	1	3440
2TL-1	40X114	1	3440

Log Profile Wall 2	
Profile	Profile

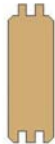
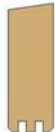
40X57	
40X114	
40X114	

# Sleeping shelter 40 big (324x254)

Wall 3

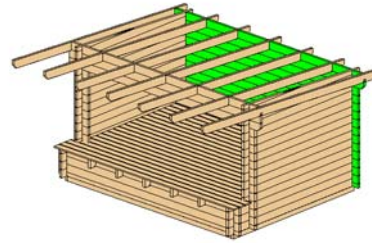

Wall 3			
Mark	Profile	Count	Cut Length
3BL-1	40x57	1	3240
3LG-1	40x114	11	3240
3LG-2	40x114	1	3240

Wall 3			
Mark	Profile	Count	Cut Length
3LG-3	40x114	1	3440
3TL-1	40x114	1	3440

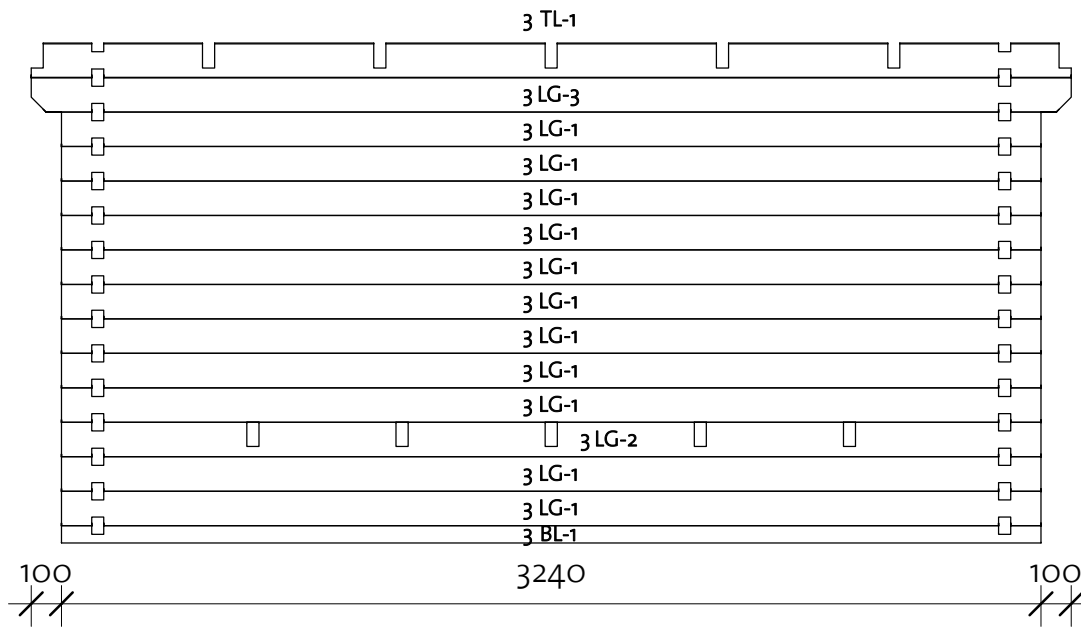

Log Profile Wall 3	
Profile	Profile

40x57	
40x114	
40x114	

# Sleeping shelter 40 big (324x254)

Wall A

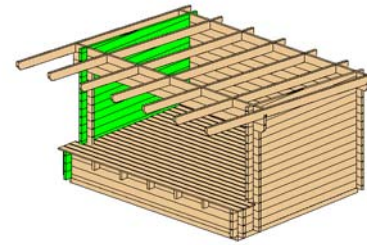

Wall A			
Mark	Profile	Count	Cut Length

ALG-1	40x114	1	1100
ALG-2	40x114	1	2240
ALG-3	40x114	10	2240
ALG-4	40x114	1	2540
ALG-5	40x114	3	2540

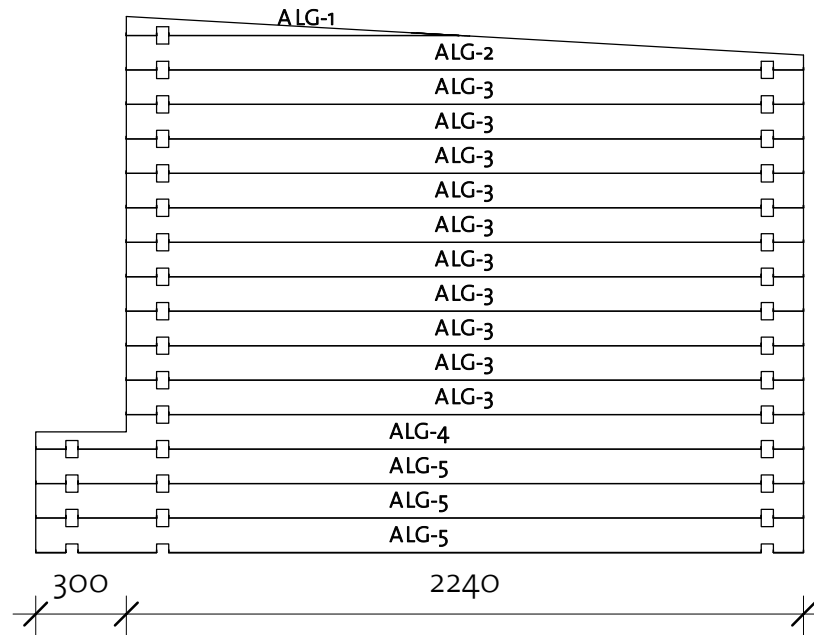

Log Profile Wall A	
Profile	Profile

40x114	
--------	--

# Sleeping shelter 40 big (324x254)

Wall B

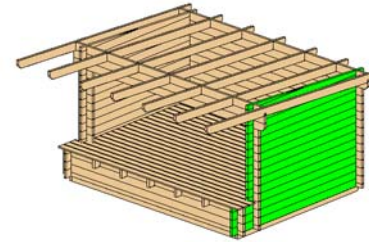

Wall B			
Mark	Profile	Count	Cut Length

BLG-1	40x114	1	1100
BLG-2	40x114	1	2240
BLG-3	40x114	10	2240
BLG-4	40x114	1	2540
BLG-5	40x114	3	2540

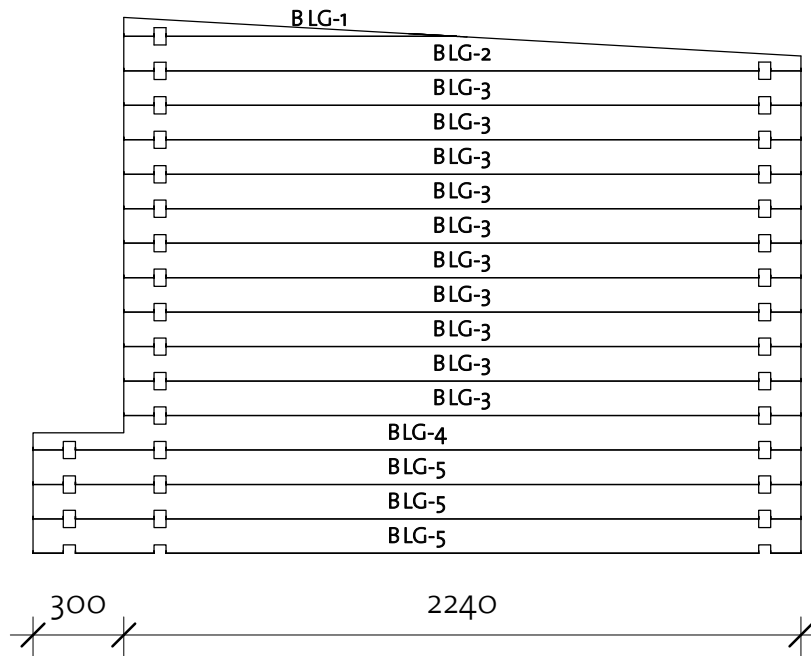

Log Profile Wall B	
Profile	Profile



40x114	
--------	--



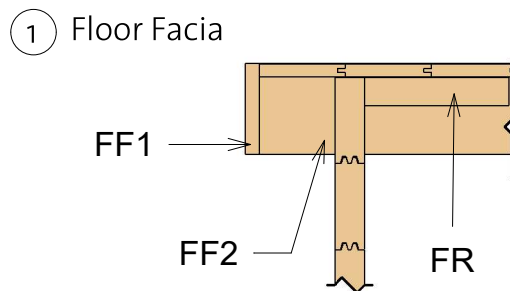
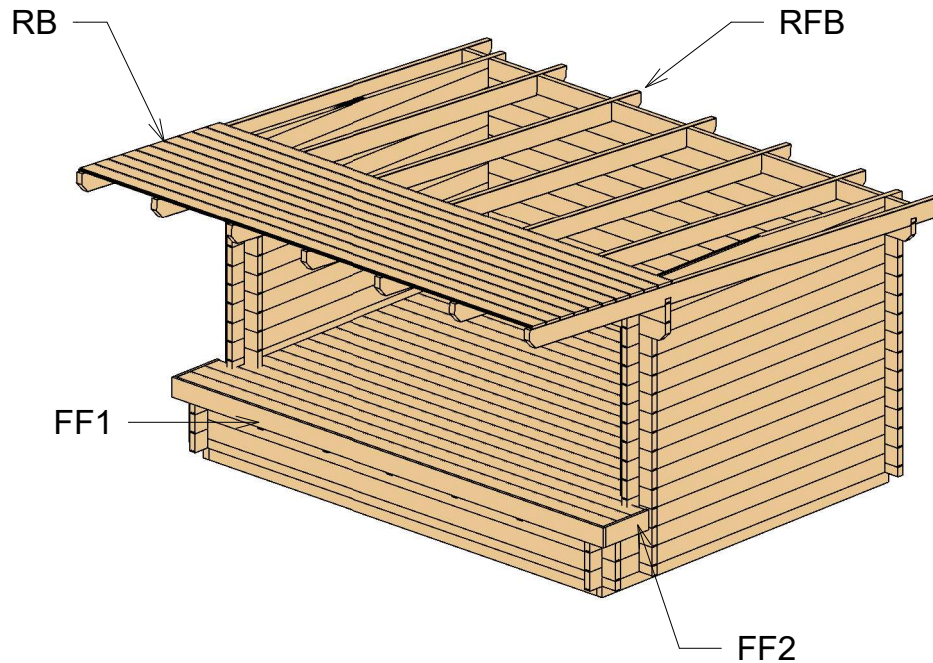

# Sleeping shelter 40 big (324x254)

Roof 1





Roof				
Mark	Type	Profile	Count	Length
RFB	Beam 40x120		7	3350
RB	17x114		31	3440

Floor Fascia				
Mark	Type	Profile	Count	Length
FF1	Floor Fascia 18x120		1	3276
FF2	Floor Fascia 18x120		2	350
FR	Floor reinforcement 38x38		2	190

# Sleeping shelter 40 big (324x254)

Roof 2

Fascia Schedule				
Mark	Type	Profile	Count	Length

EE	Eave Edging 18x40		2	3386
RF1	Roof Fascia 18x120		2	3386
RF2	Roof Fascia 18x120		2	3440

## ③ Facia

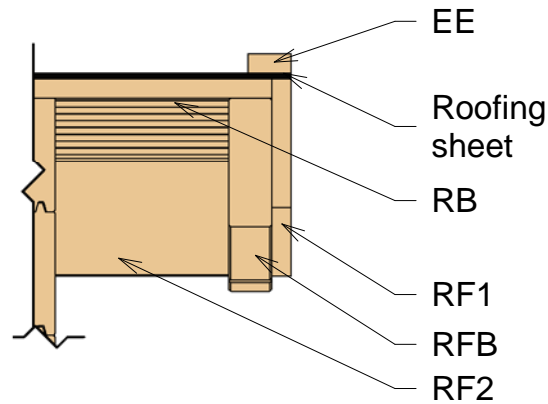
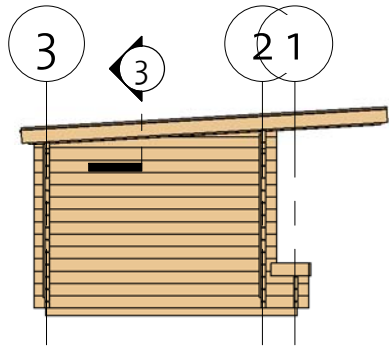

## ④ Roof Reinforcement

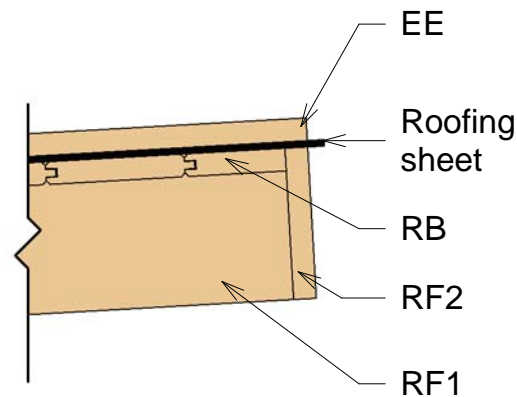
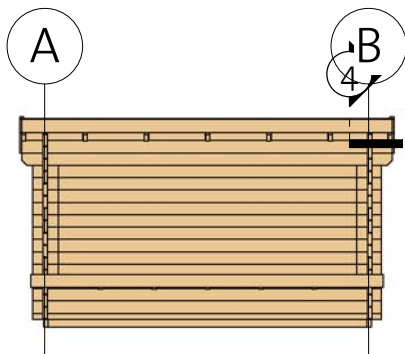

# Sleeping shelter 40 big (324x254)

Extras

Fasteners/Extras		
Name	Type	Count

Hitblock	300-400 mm	
Bolts	M8x70	12
Nails	1,4 x 40	20
Screws	5,0x 70	35
Screws	6,0 x 140	50
Screws	4,0 x 40	55
Screws	4,0 x 50	450







Type	Count	Length
------	-------	--------





Windboard 18x40	4	2200
--------------------	---	------

# Sleeping shelter 40 big (324x254)

## List of all items 1





Roof				
Mark	Type	Profile	Count	Length
RFB	Beam 40x120		7	3350
RB	17x114		31	3440

Fascia Schedule				
Mark	Type	Profile	Count	Length
EE	Eave Edging 18x40		2	3386
RF1	Roof Fascia 18x120		2	3386
RF2	Roof Fascia 18x120		2	3440

Floor Schedule				
Mark	Type	Profile	Count	Length
FB1	FB 17x114		19	2957
FB2	FB 17x114		3	3240
FLB1	Floor beam 40x120		5	2540
FLB2	Floor beam 40x70		2	1960
FLB3	Floor beam 40x70		2	260

# Sleeping shelter 40 big (324x254)

## List of all items 2

Floor Fascia					Impregnated foundation beams				
Mark	Type	Profile	Count	Length	Mark	Type	Profile	Count	Length
FF1	Floor Fascia 18x120		1	3276	IFB1	IFB 40x70		3	2950
FF2	Floor Fascia 18x120		2	350	IFB2	IFB 40x70		2	2330
FR	Floor reinforcement 38x38		2	190					

BB1	BB 20x40		1	3000
BB2	BB 20x40		2	2000

# Sleeping shelter 40 big (324x254)

## List of all items 3

Wall 1			
Mark	Profile	Count	Cut Length

1BL-1	40X57	1	3240
1LG-1	40X114	2	3240
1TL-1	40X114	1	3240

Wall 2			
Mark	Profile	Count	Cut Length

2BL-1	40X57	1	3240
2LG-1	40X114	18	240
2LG-2	40X114	2	3240
2LG-3	40X114	1	3240
2LG-4	40X114	1	3440
2LG-5	40X114	1	3440
2TL-1	40X114	1	3440

Wall 3			
Mark	Profile	Count	Cut Length

3BL-1	40X57	1	3240
3LG-1	40X114	11	3240
3LG-2	40X114	1	3240

Wall A			
Mark	Profile	Count	Cut Length

ALG-1	40X114	1	1100
ALG-2	40X114	1	2240
ALG-3	40X114	10	2240
ALG-4	40X114	1	2540
ALG-5	40X114	3	2540



Wall B			
Mark	Profile	Count	Cut Length

BLG-1	40X114	1	1100
BLG-2	40X114	1	2240
BLG-3	40X114	10	2240
BLG-4	40X114	1	2540
BLG-5	40X114	3	2540

Wall 3			
Mark	Profile	Count	Cut Length

3LG-3	40X114	1	3440
3TL-1	40X114	1	3440

Log Profiles	
Profile	Profile

40X57	
40X114	

Log Profiles	
Profile	Profile

40X114	
40X114	