

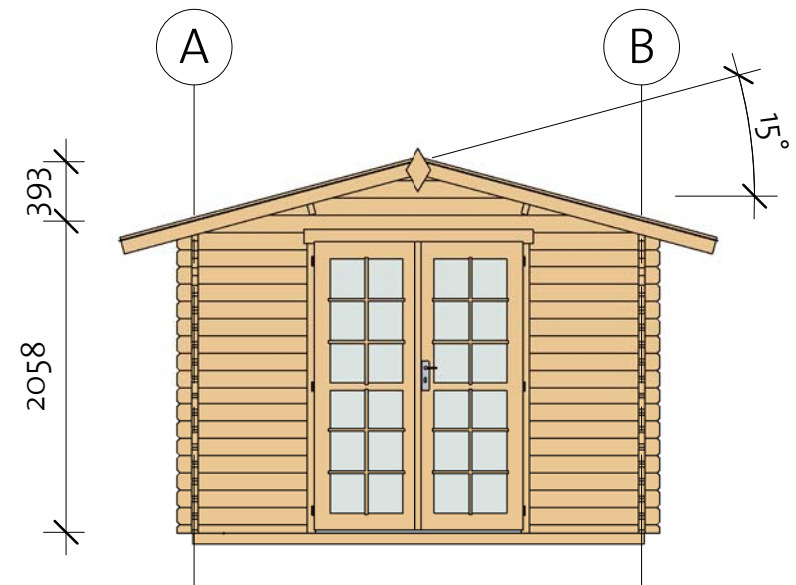

Sandra B 40 (300x300)

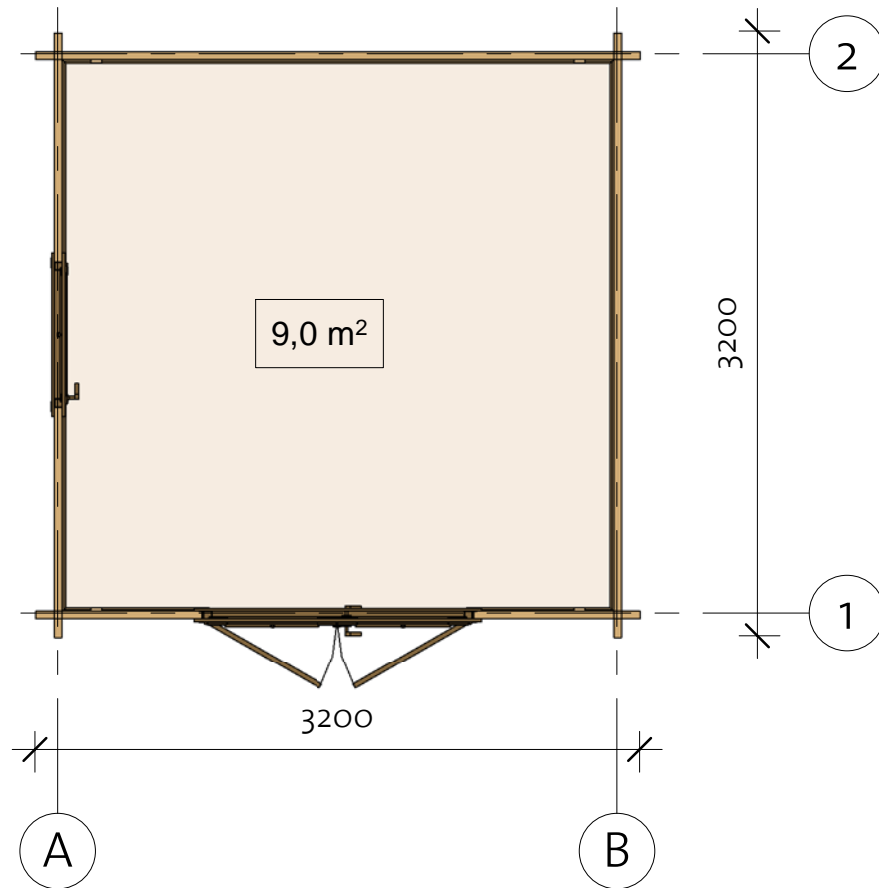
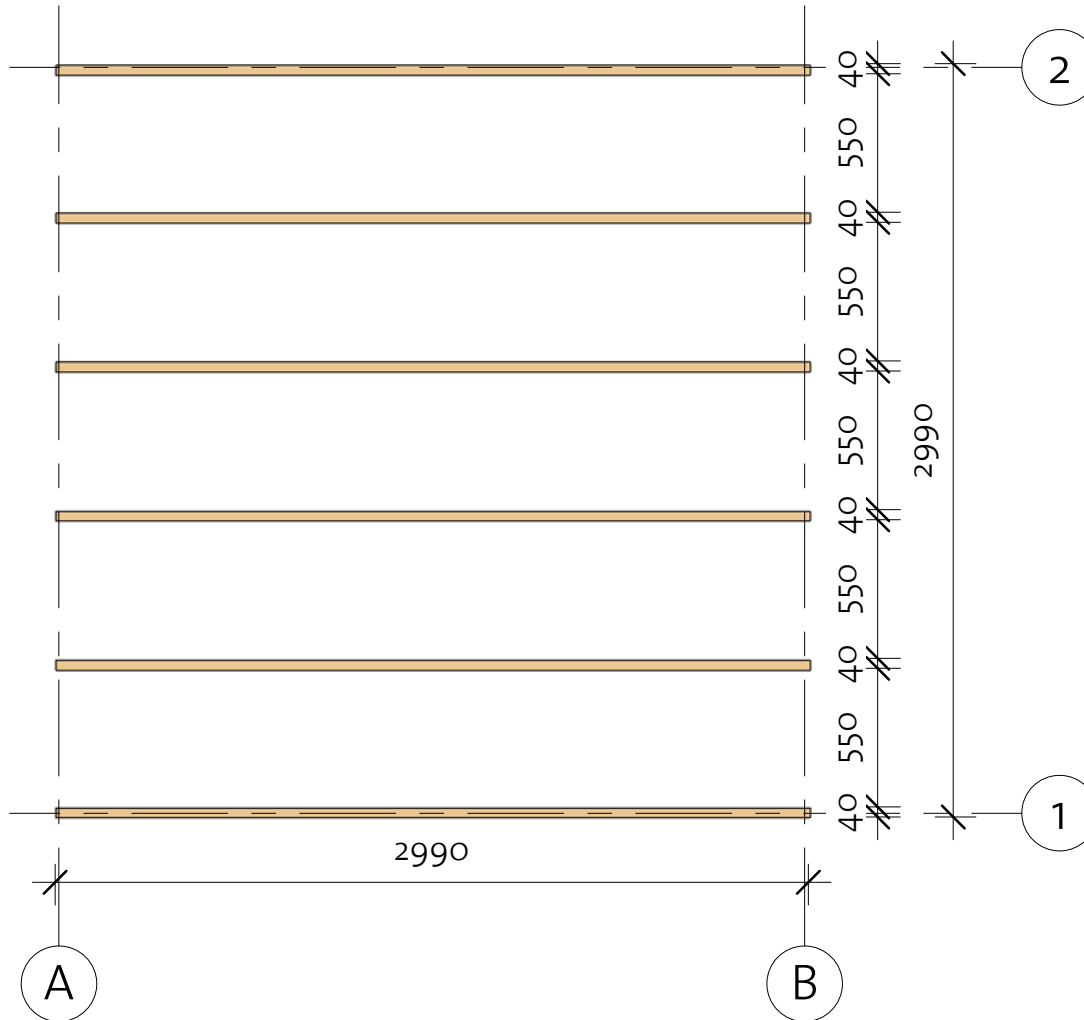

Sandra B 40 (300x300)

Foundation



Impregnated foundation beams				
Mark	Type	Profile	Count	Length
IFB	IFB 40x70		6	2990



Sandra B 40 (300x300)

Floor Plan

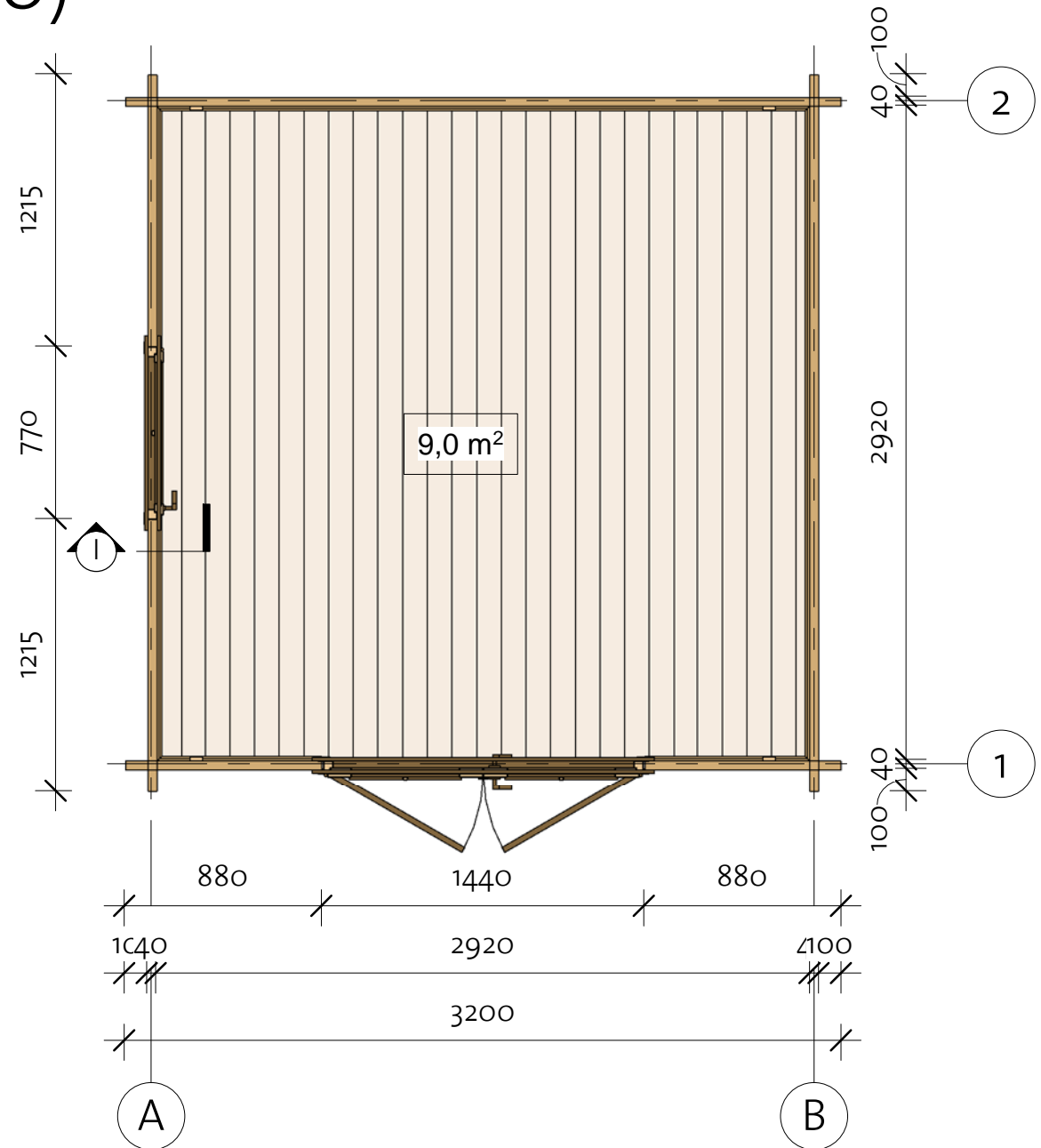
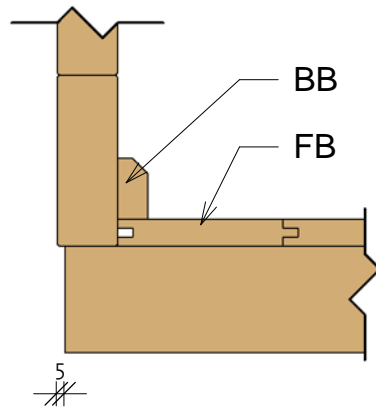
① Baseboard



Floor Schedule

Mark	Type	Profile	Count	Length
FB	FB 18x110		28	2914
BB	BB 20x40		4	3000

91812141_190308

Sandra B 40 (300x300)

Wall 1

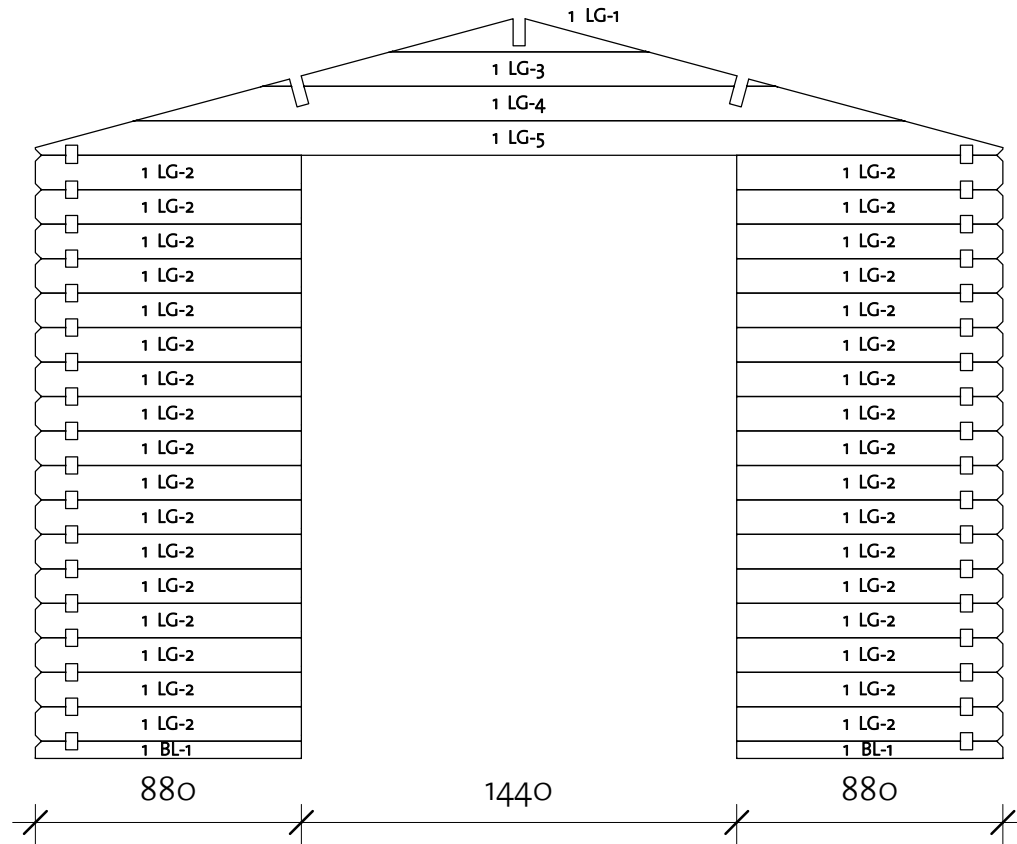
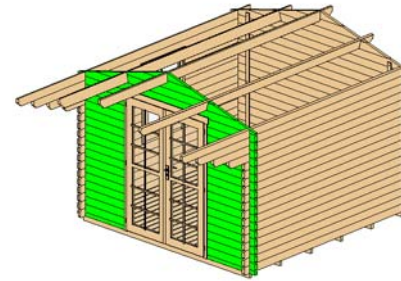



Wall 1			
Mark	Profile	Count	Cut Length

1BL-1	40X57	2	880
1LG-1 *	40X114	1	850
1LG-2	40X114	34	880
1LG-3*	40X114	1	1696
1LG-4*	40X114	1	2542
1LG-5*	40X114	1	3200

* Gable - delivered premounted

Log Profile Wall 1	
Profile	Profile

40X57	
40X114	

Sandra B 40 (300x300)

Wall 2

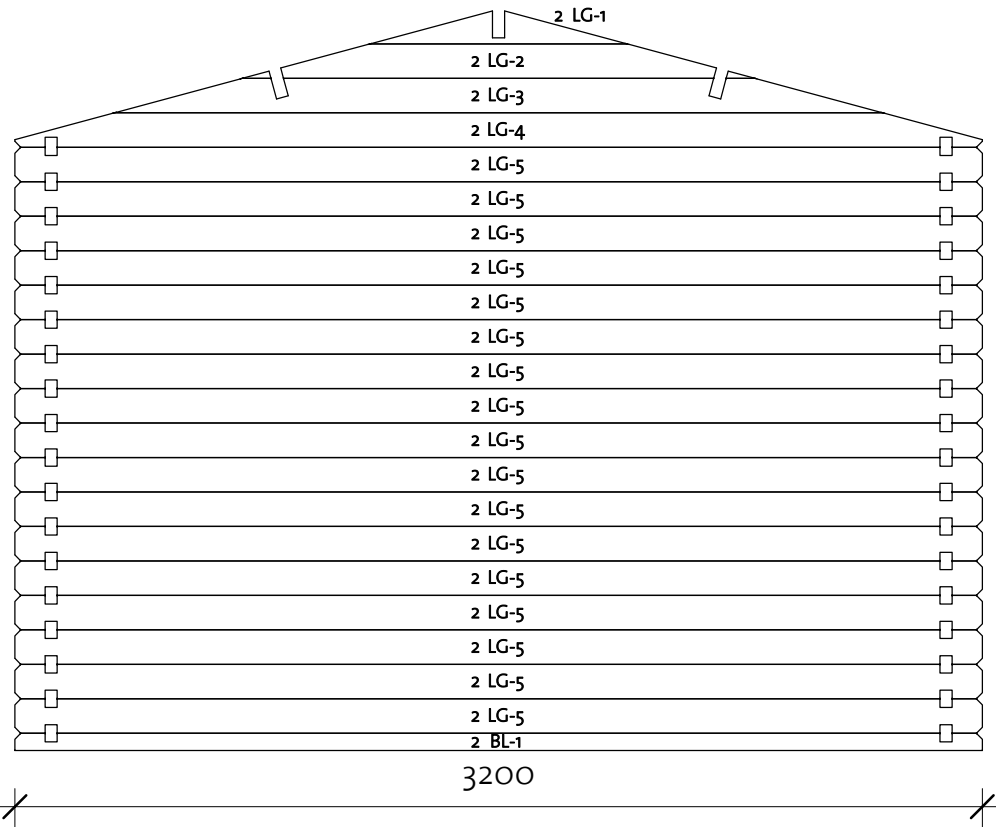

Wall 2			
Mark	Profile	Count	Cut Length

2BL-1	40X57	1	3200
2LG-1*	40X114	1	850
2LG-2*	40X114	1	1696
2LG-3*	40X114	1	2542
2LG-4*	40X114	1	3200
2LG-5	40X114	17	3200

* Gable - delivered premounted

Log Profile Wall 2	
Profile	Profile

40X57	
40X114	

Sandra B 40 (300x300)

Wall A

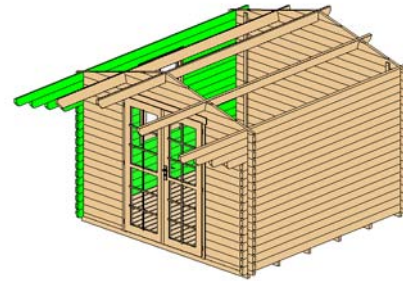

Wall A			
Mark	Profile	Count	Cut Length

ALG-1	40X114	16	1215
ALG-2	40X114	1	1515
ALG-3	40X114	1	1815
ALG-4	40X114	7	3200
ALG-5	40X114	1	4100
ATL-1	40X120	1	4500

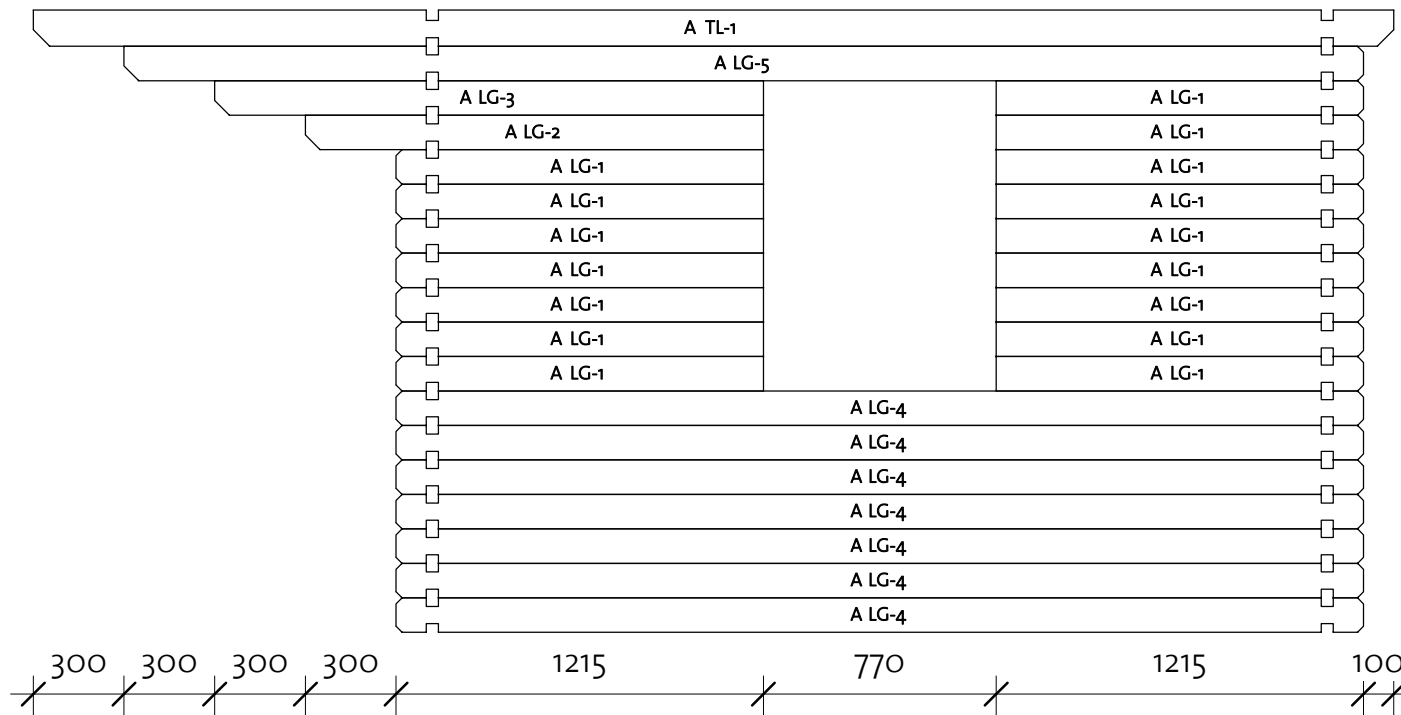

Log Profile Wall A	
Profile	Profile

40X114	
40X120	

Sandra B 40 (300x300)

Wall B

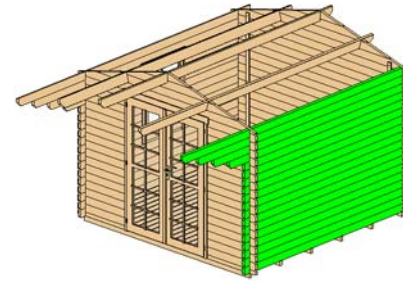

Wall B			
Mark	Profile	Count	Cut Length

BLG-1	40X114	14	3200
BLG-2	40X114	1	3500
BLG-3	40X114	1	3800
BLG-4	40X114	1	4100
BTL-1	40X120	1	4500

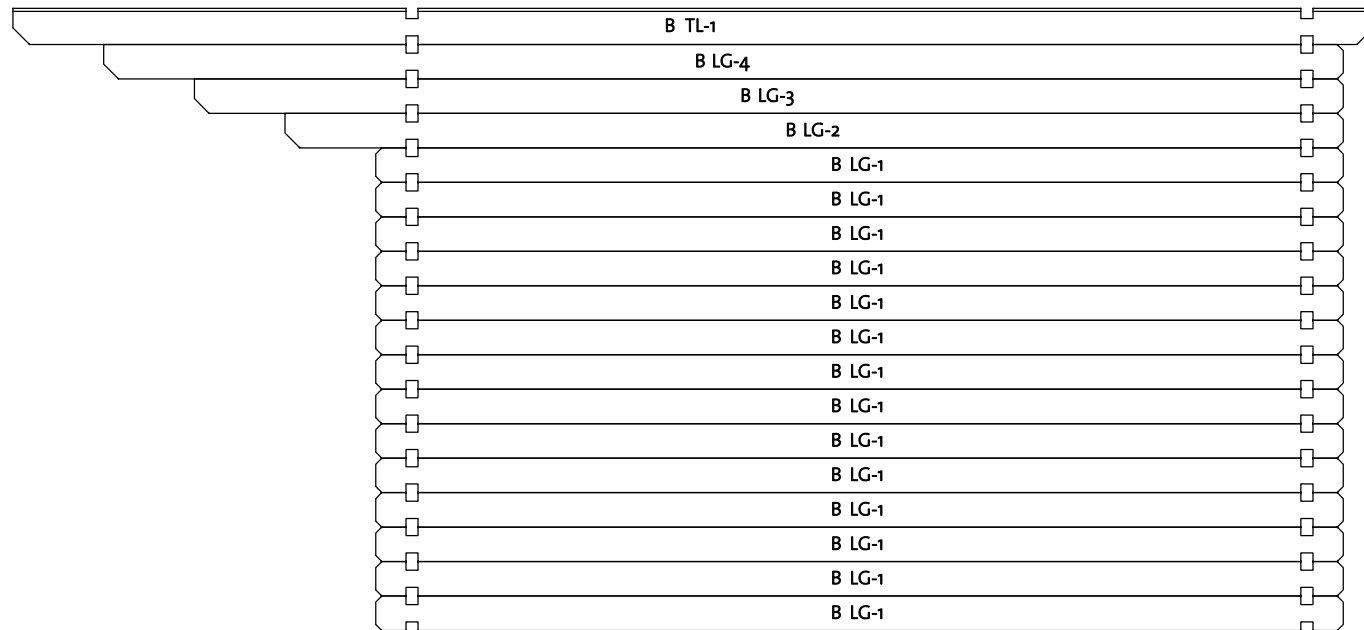





Log Profile Wall B	
Profile	Profile

40X114	
40X120	

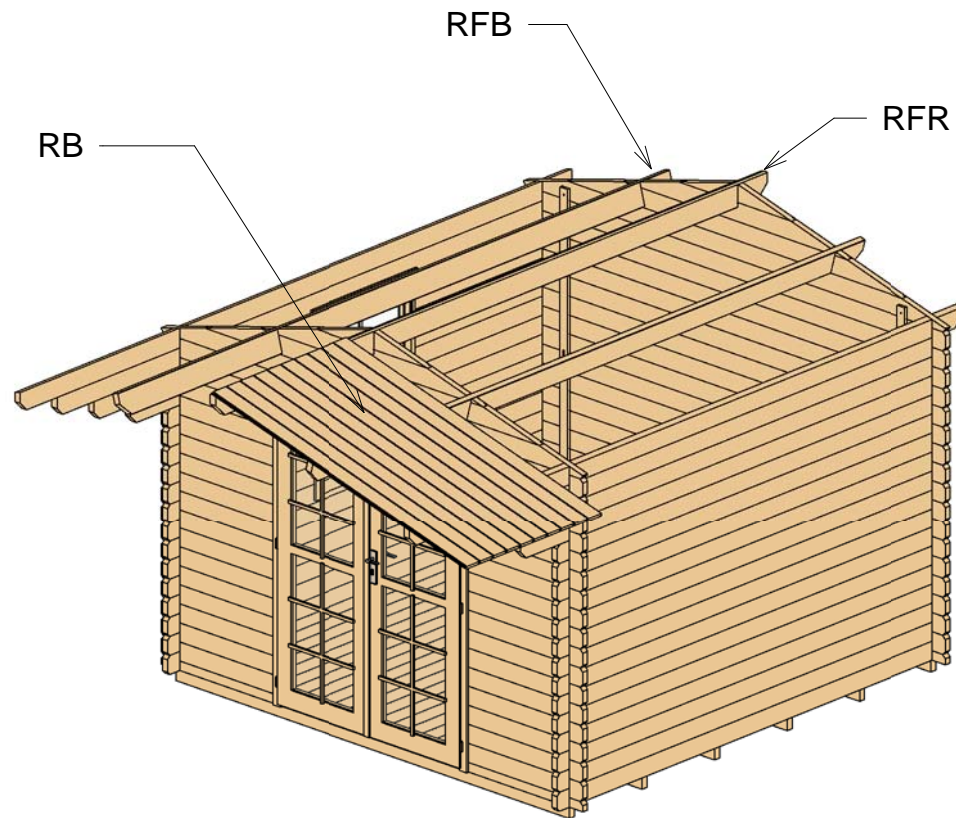
Sandra B 40 (300x300)

Roof 1



Roof				
Mark	Type	Profile	Count	Length
RFR	Ridge 40x143		1	4500
RFB	Beam 40x143		2	4500
RB	18x110		84	2000

Sandra B 40 (300x300)

Roof 2

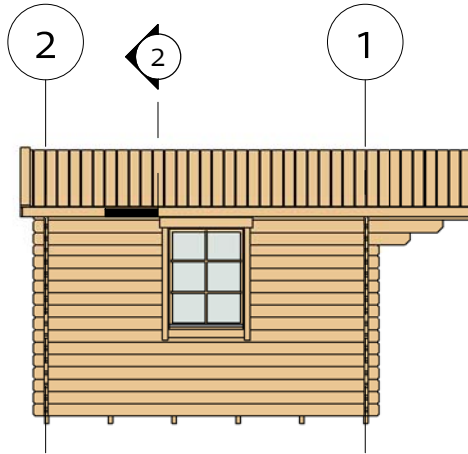

② Facia

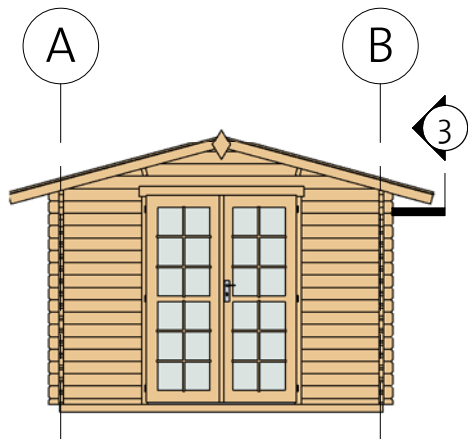
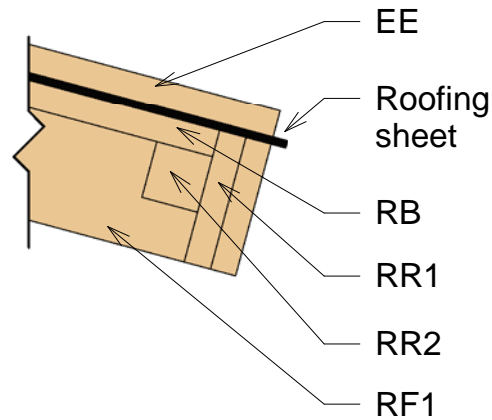

③ Roof Reinforcement

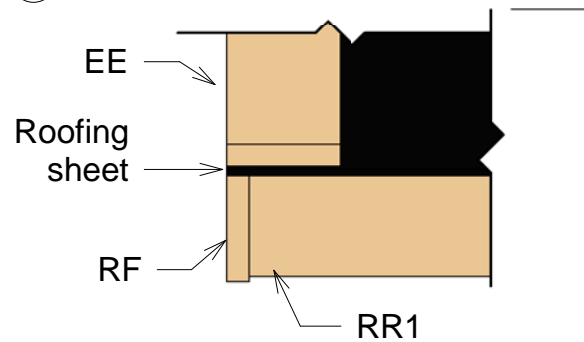

Fascia Schedule				
Mark	Type	Profile	Count	Length
EE	Eave Edging 18x90		4	2040
RF	Roof Fascia 18x90		4	2040
RR1	Roof reinforcement 18x90		2	4500
RR2	Roof reinforcement 38x38		2	4500

Sandra B 40 (300x300)

Extras

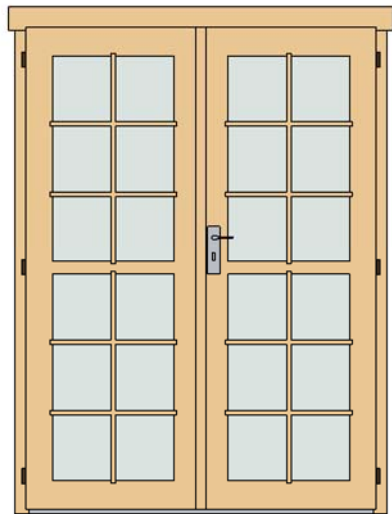

Door Schedule				
Mark	Type	Width	Height	Count
CDD17R	Classic double door 17, two glass right	1425	1955	1
DCB6	Door Crossbar 6	--	--	4

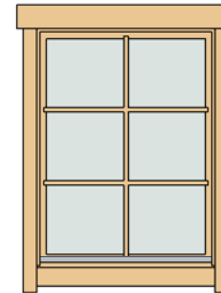

Window Schedule				
Mark	Type	Height	Width	Count
CW1R	Classic window 1 right	990	765	1
WCB6	Windows Crossbar 6	--	--	1

Fasteners & Extras		
Name	Type	Count

Hitblock	300-400 mm	
Screws	5,0 x 70	10
Bolts	M8 x 70	12
Screws	6,0 x 140	25
Nails	1,4 x 40	30
Screws	4,0 x 40	90
Screws	4,0 x 50	450

Type	Count	Length
------	-------	--------

Windboard 18x40	4	2010
-----------------	---	------



Type	Count
------	-------

Romb	2
------	---

91812141_190308



Sandra B 40 (300x300)

List of all items 1



Impregnated foundation beams

Mark	Type	Profile	Count	Length
IFB	IFB 40x70		6	2990





Floor Schedule

Mark	Type	Profile	Count	Length
FB	FB 18x110		28	2914
BB	BB 20x40		4	3000

Roof

Mark	Type	Profile	Count	Length
RFR	Ridge 40x143		1	4500
RFB	Beam 40x143		2	4500
RB	18x110		84	2000

Fascia Schedule

Mark	Type	Profile	Count	Length
EE	Eave Edging 18x90		4	2040
RF	Roof Fascia 18x90		4	2040
RR1	Roof reinforcement 18x90		2	4500
RR2	Roof reinforcement 38x38		2	4500

Sandra B 40 (300x300)

List of all items 2

Wall 1			
Mark	Profile	Count	Cut Length

1BL-1	40X57	2	880
1LG-1*	40X114	1	850
1LG-2	40X114	34	880
1LG-3*	40X114	1	1696
1LG-4*	40X114	1	2542
1LG-5*	40X114	1	3200

Wall 2			
Mark	Profile	Count	Cut Length

2BL-1	40X57	1	3200
2LG-1*	40X114	1	850
2LG-2*	40X114	1	1696
2LG-3*	40X114	1	2542
2LG-4*	40X114	1	3200
2LG-5	40X114	17	3200

* Gable - delivered premounted



Wall A			
Mark	Profile	Count	Cut Length

ALG-1	40X114	16	1215
ALG-2	40X114	1	1515
ALG-3	40X114	1	1815
ALG-4	40X114	7	3200
ALG-5	40X114	1	4100
ATL-1	40X120	1	4500

Wall B			
Mark	Profile	Count	Cut Length

BLG-1	40X114	14	3200
BLG-2	40X114	1	3500
BLG-3	40X114	1	3800
BLG-4	40X114	1	4100
BTL-1	40X120	1	4500

Log Profiles	
Profile	Profile

40X57	
40X114	

Log Profiles	
Profile	Profile

40X120	
--------	---