

Alabama 28 (335x274)

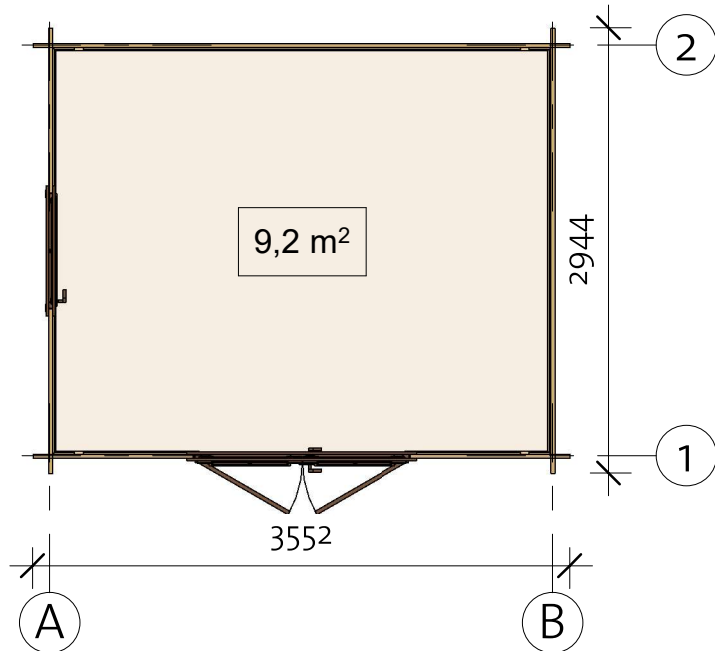

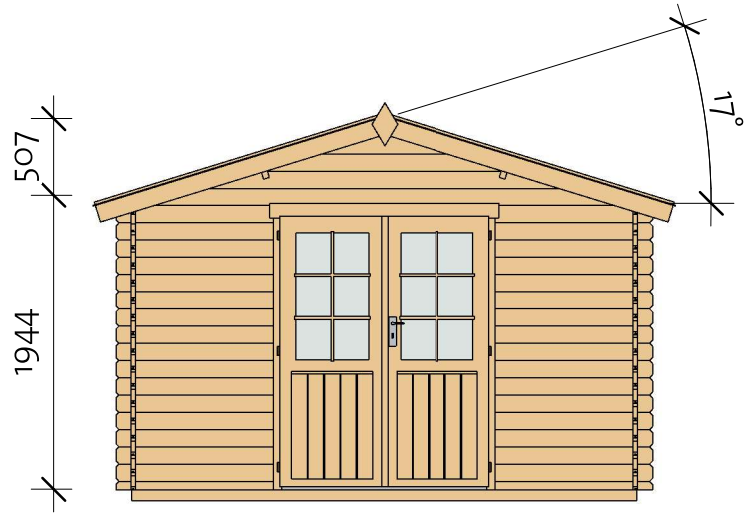

190418

Alabama 28 (335x274)

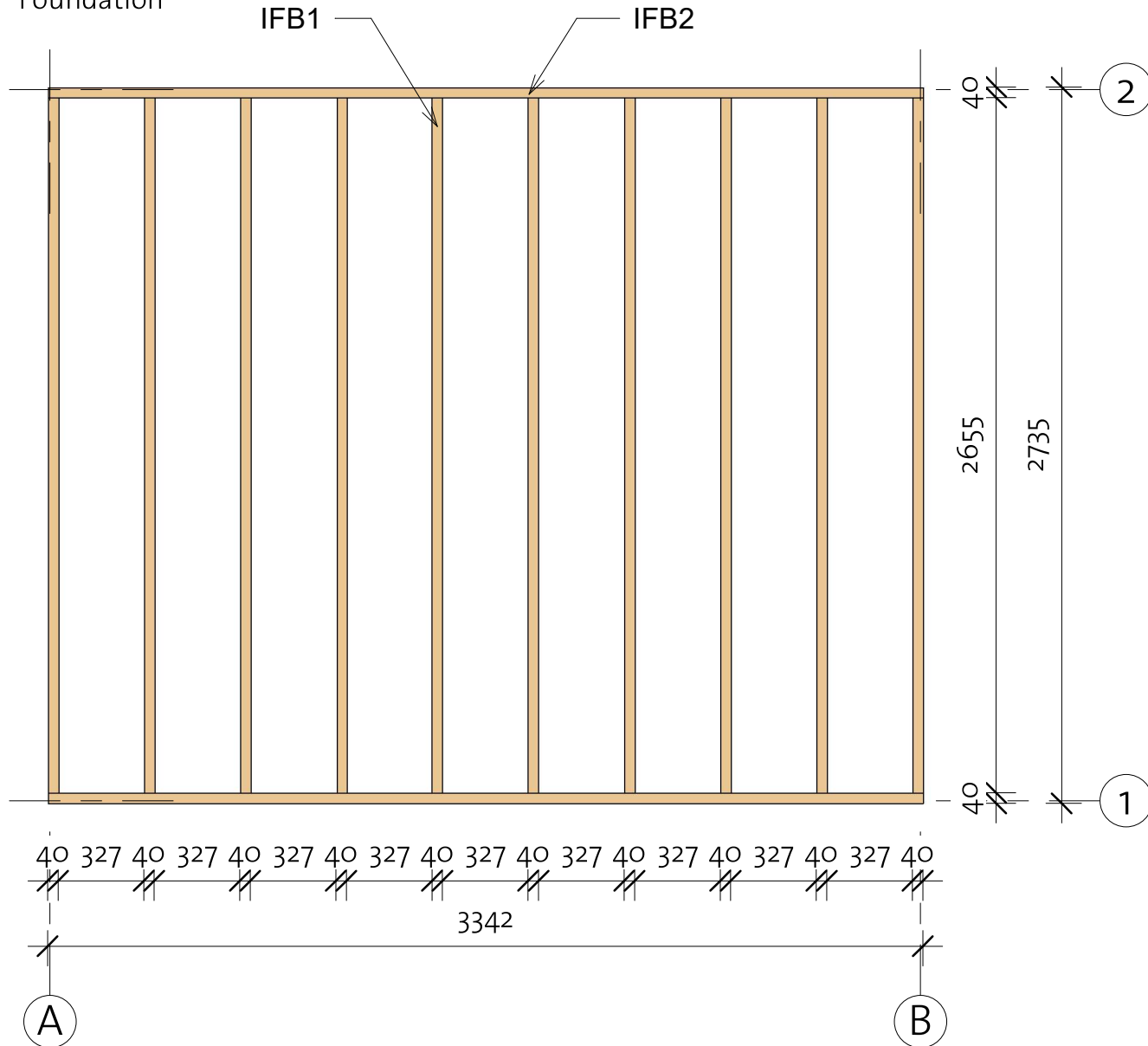
Foundation



Impregnated foundation beams

Mark	Type	Profile	Length	Count
IFB1	IFB 40x70		2655	10
IFB2	IFB 40x70		3342	2

Alabama 28 (335x274)

Floor Plan

① Baseboard

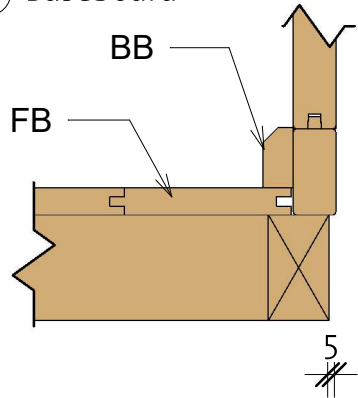

Floor Schedule

Mark	Type	Profile	Count	Length
------	------	---------	-------	--------

FB	FB 18x110		26	3293
----	--------------	---	----	------

BB1	BB 20x40		2	2750
BB2	BB 20x40		2	3350

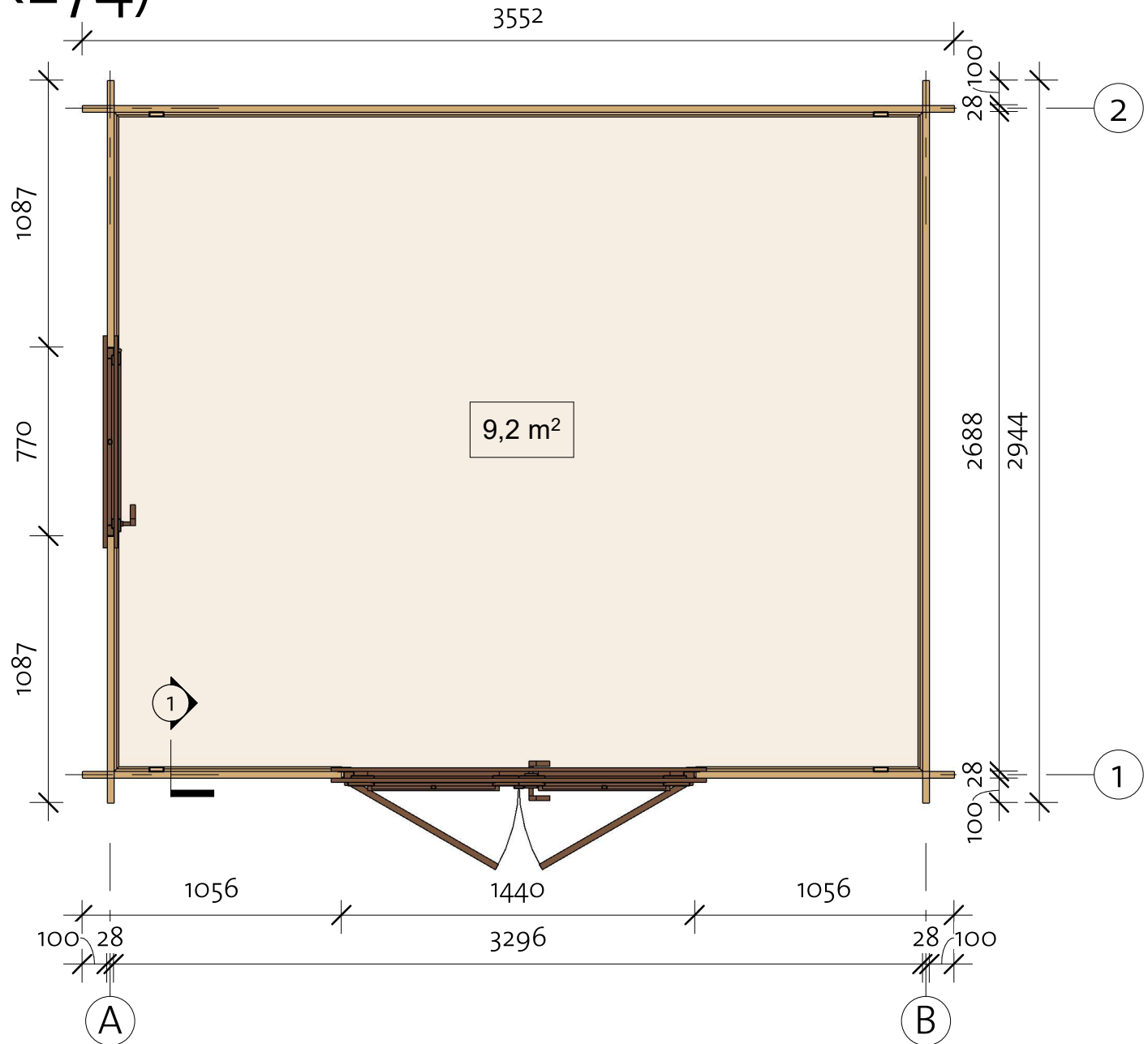

Alabama 28 (335x274)

Wall 1

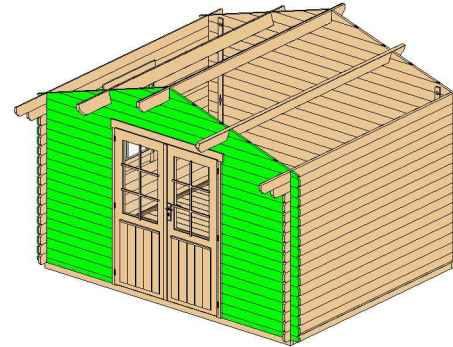

Wall 1

Mark	Profile	Count	Cut Length
------	---------	-------	------------

1BL 1	28x57	2	1056
1LG 1 *	28x114	1	747
1LG 2	28x114	32	1056
1LG 3 *	28x114	1	3552
1LG 4 *	28x114	1	1488
1LG 5 *	28x114	1	2230
1LG 6 *	28x114	1	2971

*Gable-delivered premounted

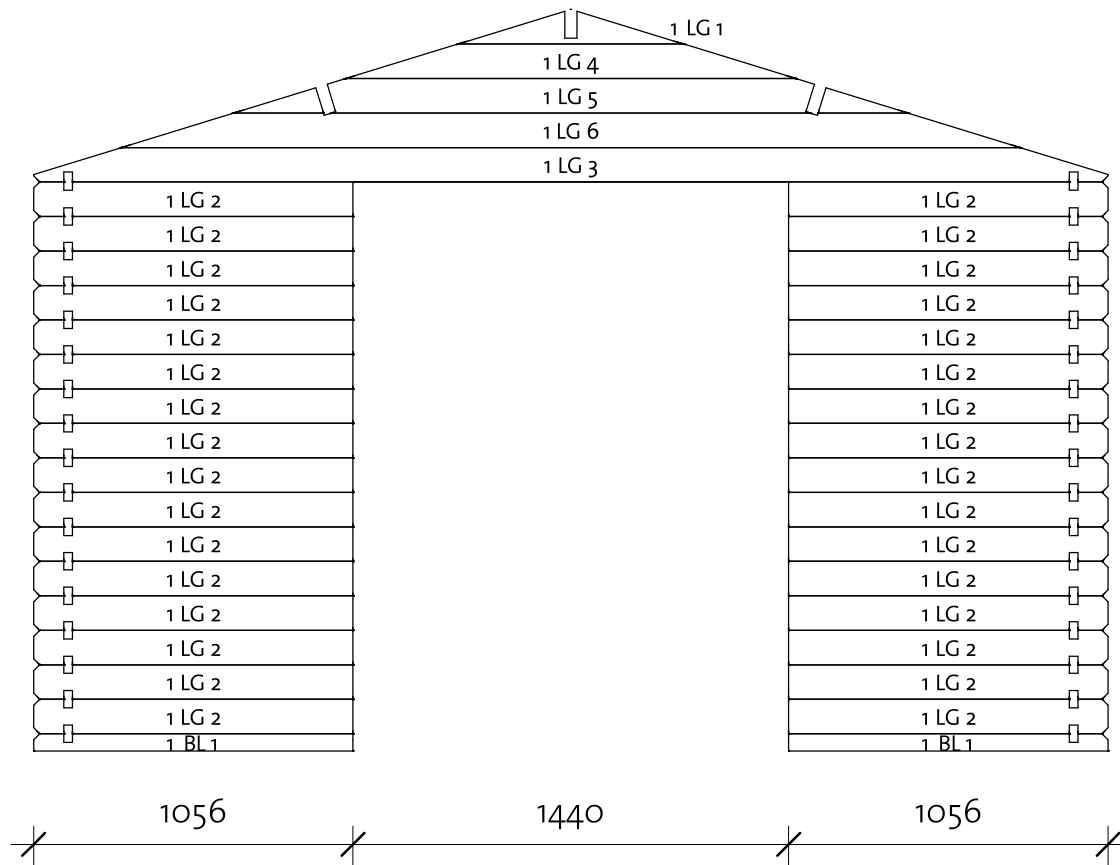

Log Profile Wall 1

Profile	Profile
---------	---------

28x57	
28x114	

Alabama 28 (335x274)

Wall 2

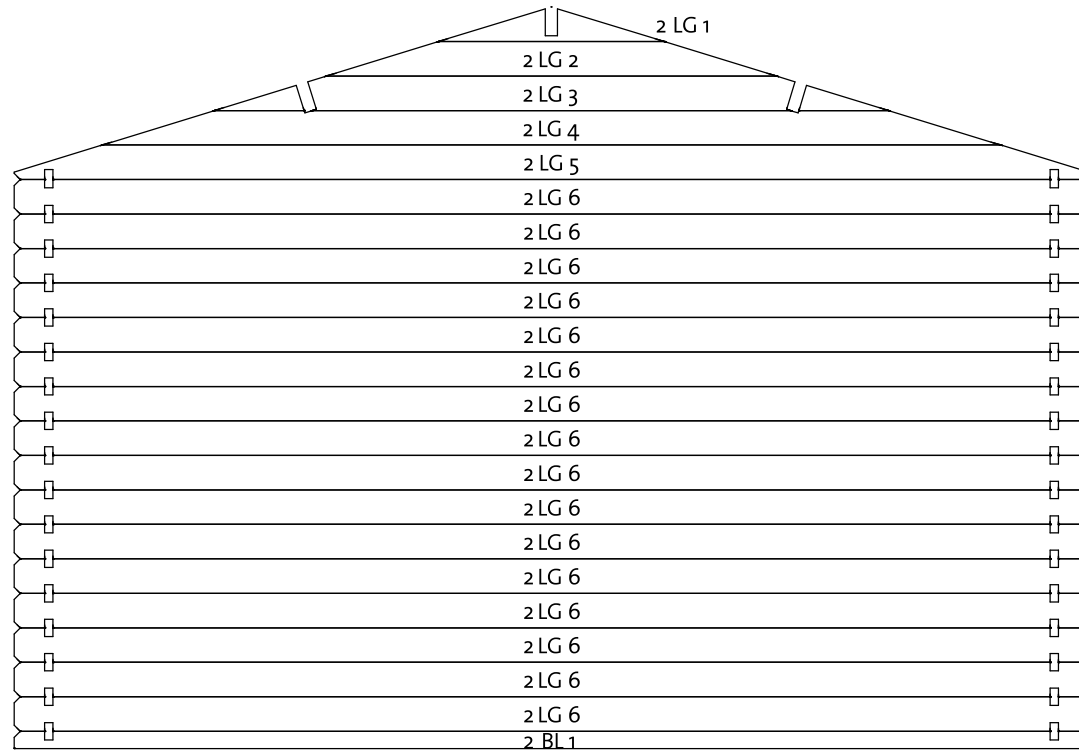
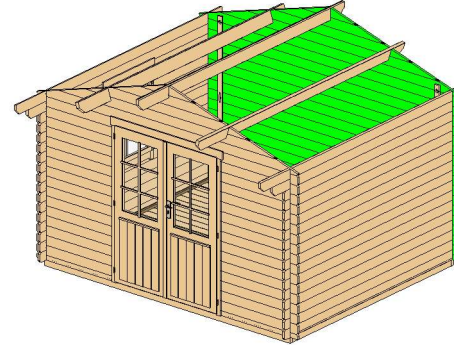

Wall 2			
Mark	Profile	Count	Cut Length

2BL 1	28x57	1	3552
2LG 1*	28x114	1	747
2LG 2*	28x114	1	1488
2LG 3*	28x114	1	2230
2LG 4*	28x114	1	2971
2LG 5*	28x114	1	3552
2LG 6	28x114	16	3552

*Gable-delivered premounted

Log Profile Wall 2	
Profile	Profile

28x57	
28x114	

Alabama 28 (335x274)

Wall A

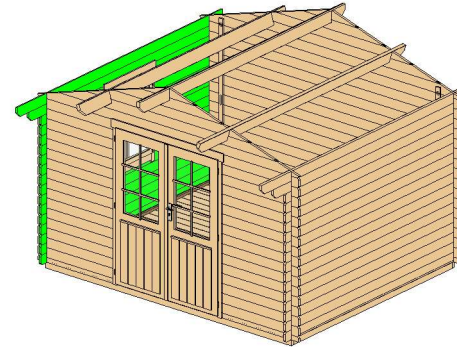

Wall A			
Mark	Profile	Count	Cut Length

ALG 1	28x114	18	1087
ALG 2	28x114	6	2944
ALG 3	28x114	1	3144
ATL 1	28x120	1	3444

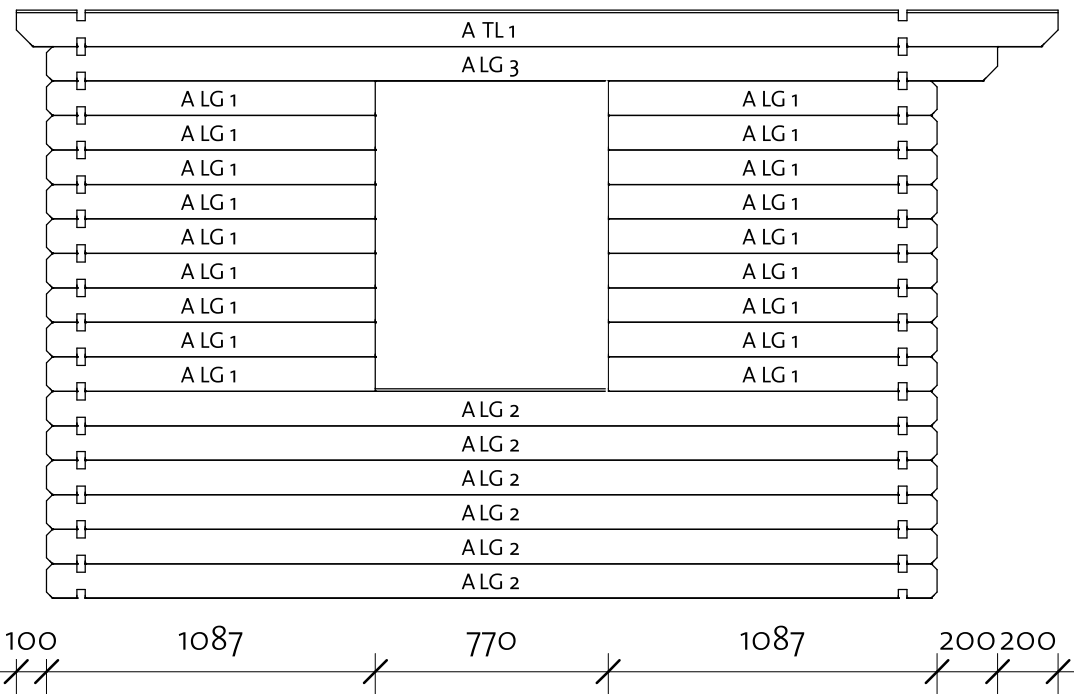

Log Profile Wall A	
Profile	Profile

28x114	
28x120	

Alabama 28 (335x274)

Wall B

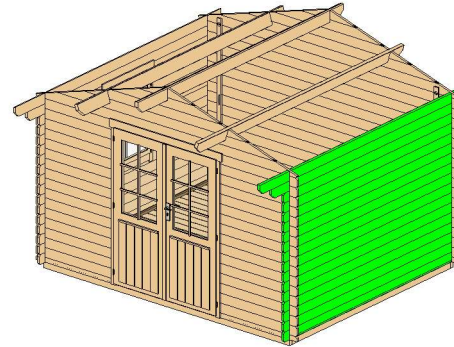

Wall B			
Mark	Profile	Count	Cut Length

BLG 1	28x114	15	2944
BLG 2	28x114	1	3144
BTL 1	28x120	1	3444

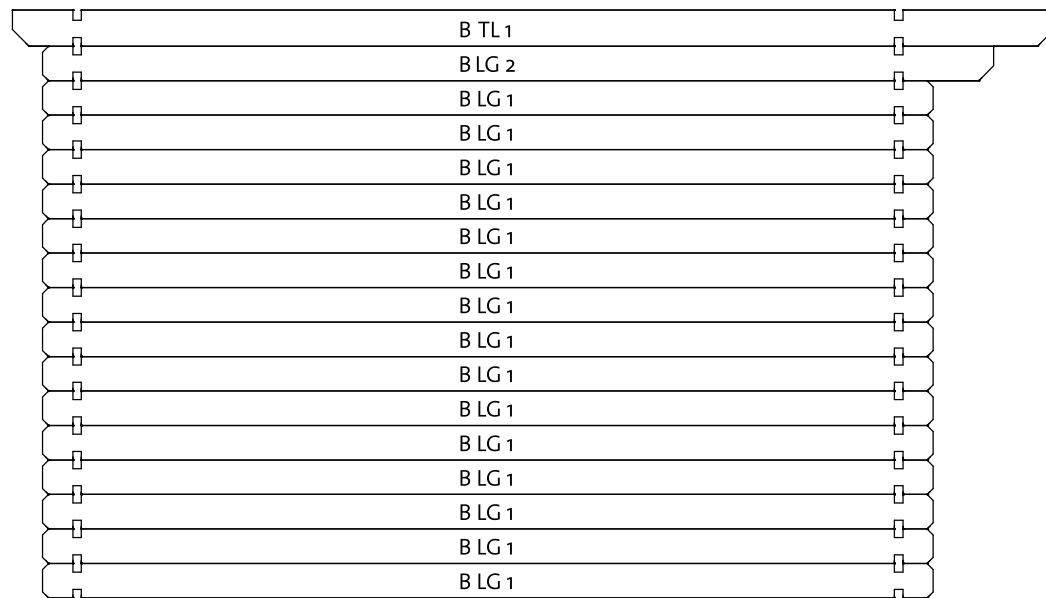





Log Profile Wall B	
Profile	Profile

28x114	
28x120	

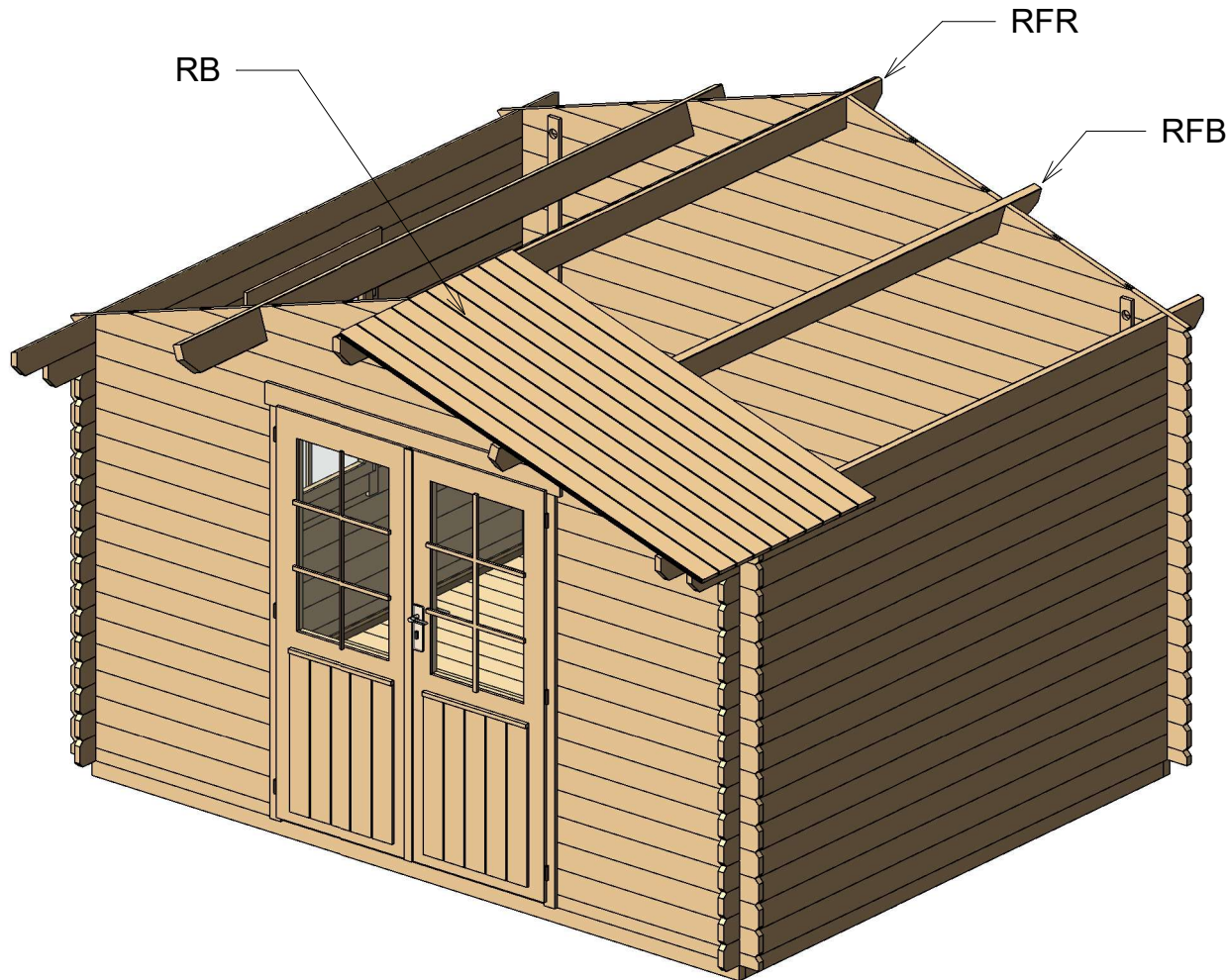
Alabama 28 (335x274)

Roof 1



Roof				
Mark	Type	Profile	Count	Length
RFR	Ridge 40x143		1	3444
RFB	Beam 40x143		2	3444
RB	18x110		66	1960

Alabama 28 (335x274)

Roof 2

① Facia

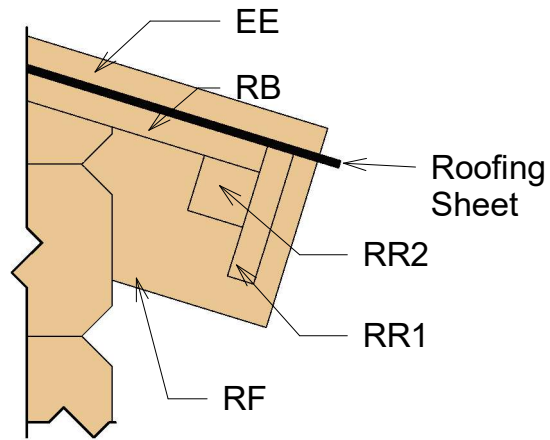
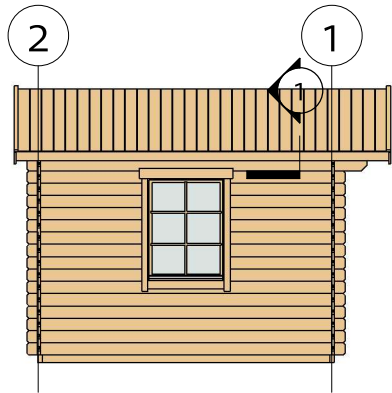

② Roof Reinforcement

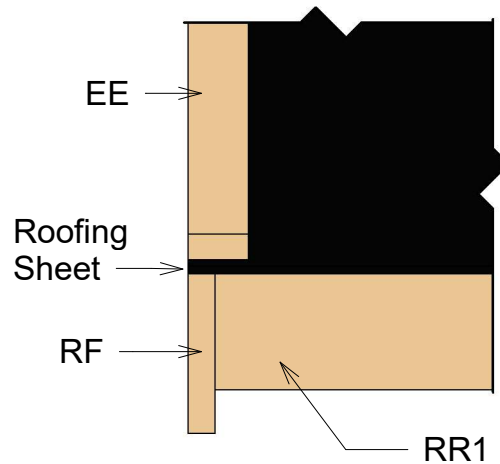
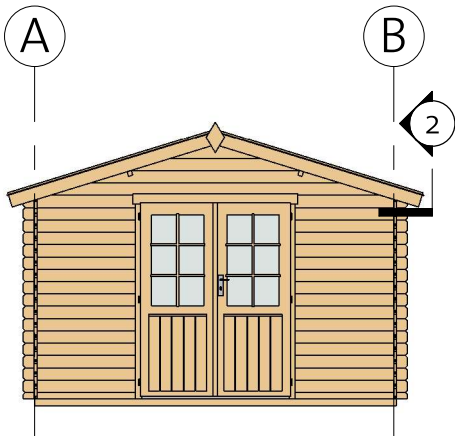

Fascia Schedule

Mark	Type	Profile	Count	Length
EE	Eave Edging 18x40		4	2000
RF	Roof Fascia 18x115		4	2000
RR1	Roof reinforcement 18x90		2	3444
RR2	Roof reinforcement 38x38		2	3444

Alabama 28 (335x274)

Extras



Door Schedule				
Model	Type	Width	Height	Count
BDD5R	Basic double door 5 right	1425	1835	1
DCB6	Door crossbar 6	--	--	2

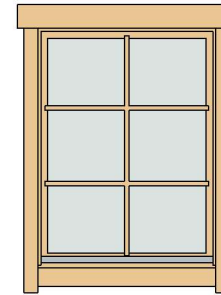

Window Schedule				
Model	Type	Width	Height	Count
BW1R	Basic window 1 right	765	990	1
WCB6	Window crossbar 6	--	--	1

Fasteners/Extras		
Name	Comments	Count

Hitblock	300-400 mm	
Screws	5,0 x 70	10
Bolts	M8 x 60	12
Nails	1,4 x 40	30
Screws	6,0 x 140	45
Screws	4,0 x 40	65
Screws	4,0 x 50	500



Type	Count	Length
Windboard 18x40	4	2200





Type	Count
Romb	2



Alabama 28 (335x274)

List of all items 1



Impregnated foundation beams				
Mark	Type	Profile	Length	Count

IFB1	IFB 40x70		2655	10
IFB2	IFB 40x70		3342	2





Floor Schedule				
Mark	Type	Profile	Count	Length

FB	FB 18x110		26	3293
BB1	BB 20x40		2	2750
BB2	BB 20x40		2	3350

Roof				
Mark	Type	Profile	Count	Length

RFR	Ridge 40x143		1	3444
RFB	Beam 40x143		2	3444
RB	18x110		66	1960

Fascia Schedule				
Mark	Type	Profile	Count	Length

EE	Eave Edging 18x40		4	2000
RF	Roof Fascia 18x115		4	2000
RR1	Roof reinforcement 18x90		2	3444
RR2	Roof reinforcement 38x38		2	3444

Alabama 28 (335x274)

List of all items 2

Wall 1			
Mark	Profile	Count	Cut Length

1BL 1	28x57	2	1056
1LG 1*	28x114	1	747
1LG 2	28x114	32	1056
1LG 3*	28x114	1	3552
1LG 4*	28x114	1	1488
1LG 5*	28x114	1	2230
1LG 6*	28x114	1	2971

Wall 2			
Mark	Profile	Count	Cut Length

2BL 1	28x57	1	3552
2LG 1*	28x114	1	747
2LG 2*	28x114	1	1488
2LG 3*	28x114	1	2230
2LG 4*	28x114	1	2971
2LG 5*	28x114	1	3552
2LG 6	28x114	16	3552

Wall A			
Mark	Profile	Count	Cut Length



ALG 1	28x114	18	1087
ALG 2	28x114	6	2944
ALG 3	28x114	1	3144
ATL 1	28x120	1	3444

Wall B			
Mark	Profile	Count	Cut Length

BLG 1	28x114	15	2944
BLG 2	28x114	1	3144
BTL 1	28x120	1	3444

*Gable-delivered premounted

Log Profiles	
Profile	Profile

28x57	
28x114	

Log Profiles	
Profile	Profile

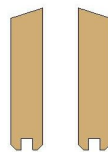
28x120	
--------	--