

Ontario Bunkie 1 9/16" (10 5/8" x 14 3/16")

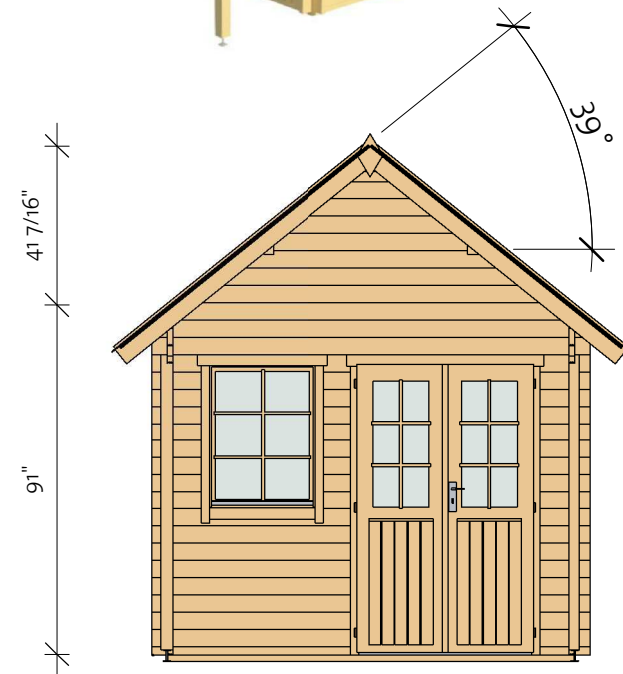

Ontario Bunkie 1 9/16" (10 5/8" x 14 3/16")

Foundation

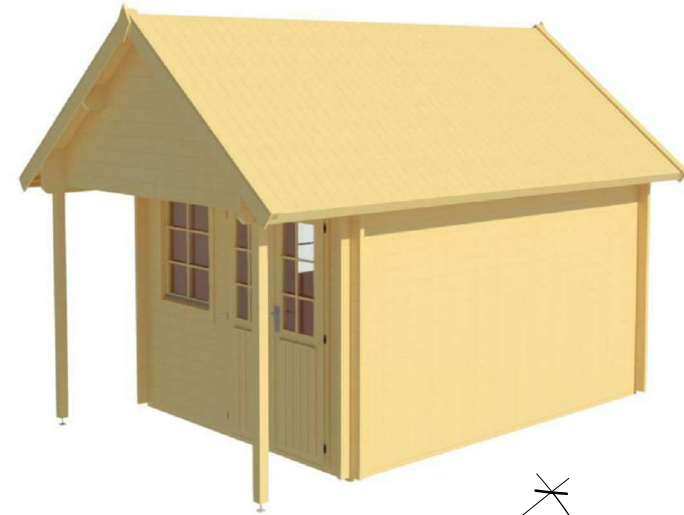
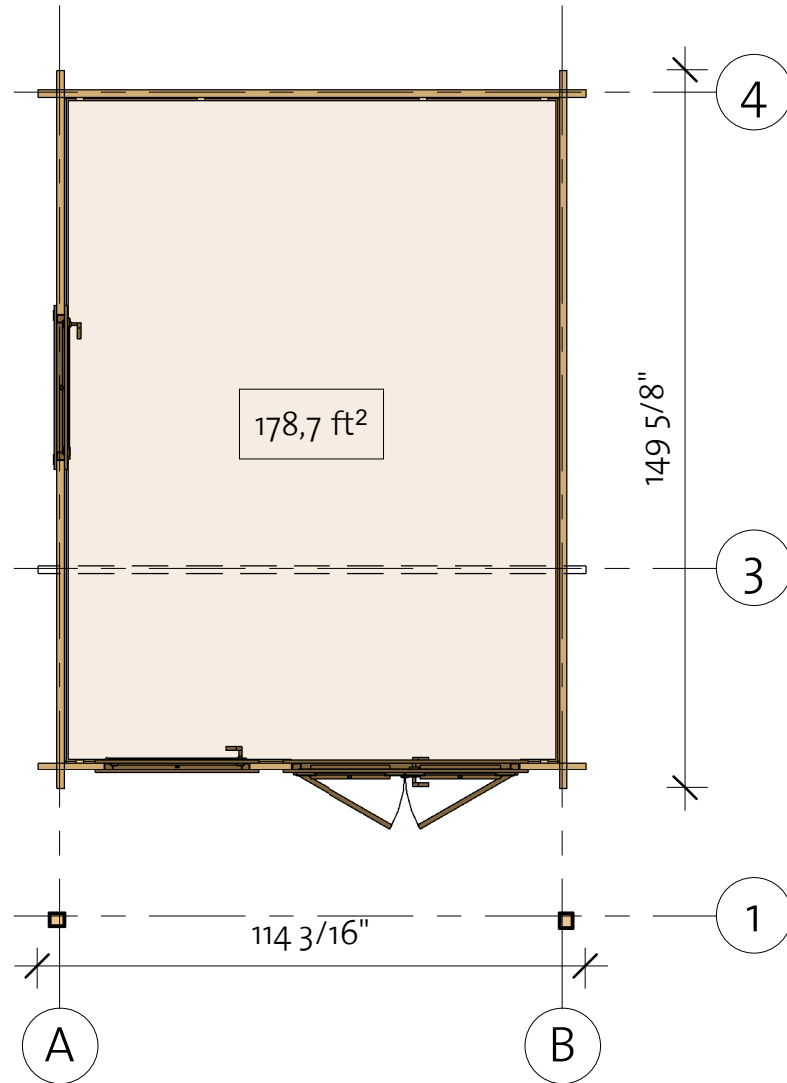
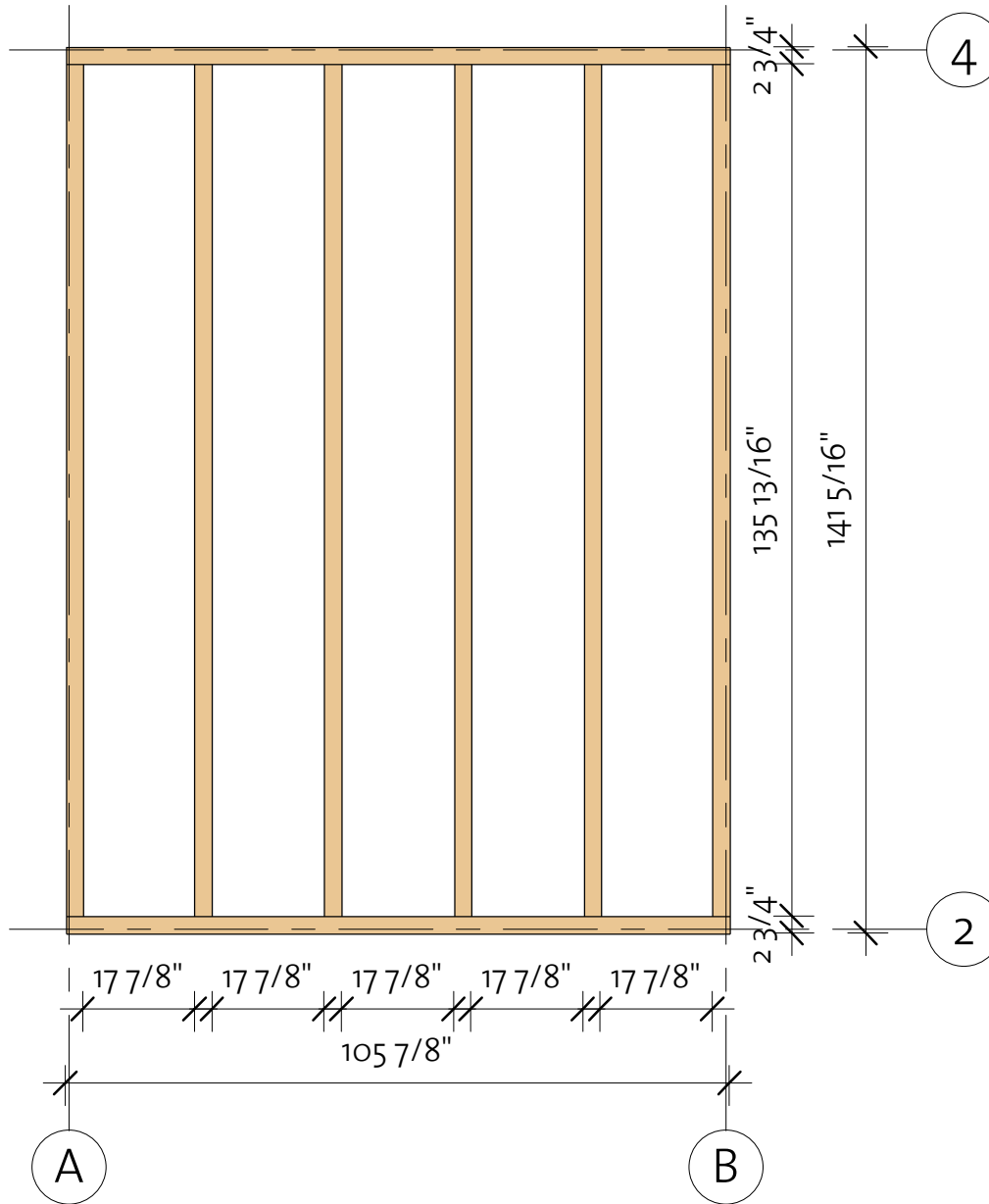

Impregnated foundation beams				
Mark	Type	Profile	Count	Length
IFB1	IFB 70x40		6	135 13/16"
IFB2	IFB 70x40		2	105 7/8"

Ontario Bunkie 1 9/16" (10 5/8" x 14 3/16")

Floor Plan

① Baseboard

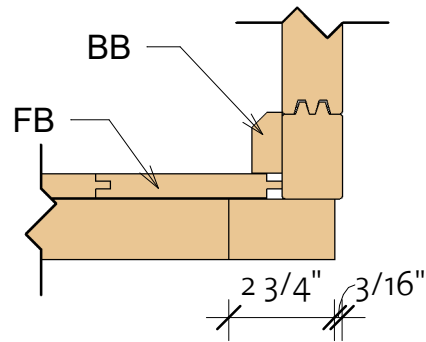

Floor Schedule				
Mark	Type	Profile	Count	Length
FB1	FB 17x114		32	103 1/16"
FB2	FB 17x114		24	72 13/16"
BB	BB 20x40		5	3800

201014

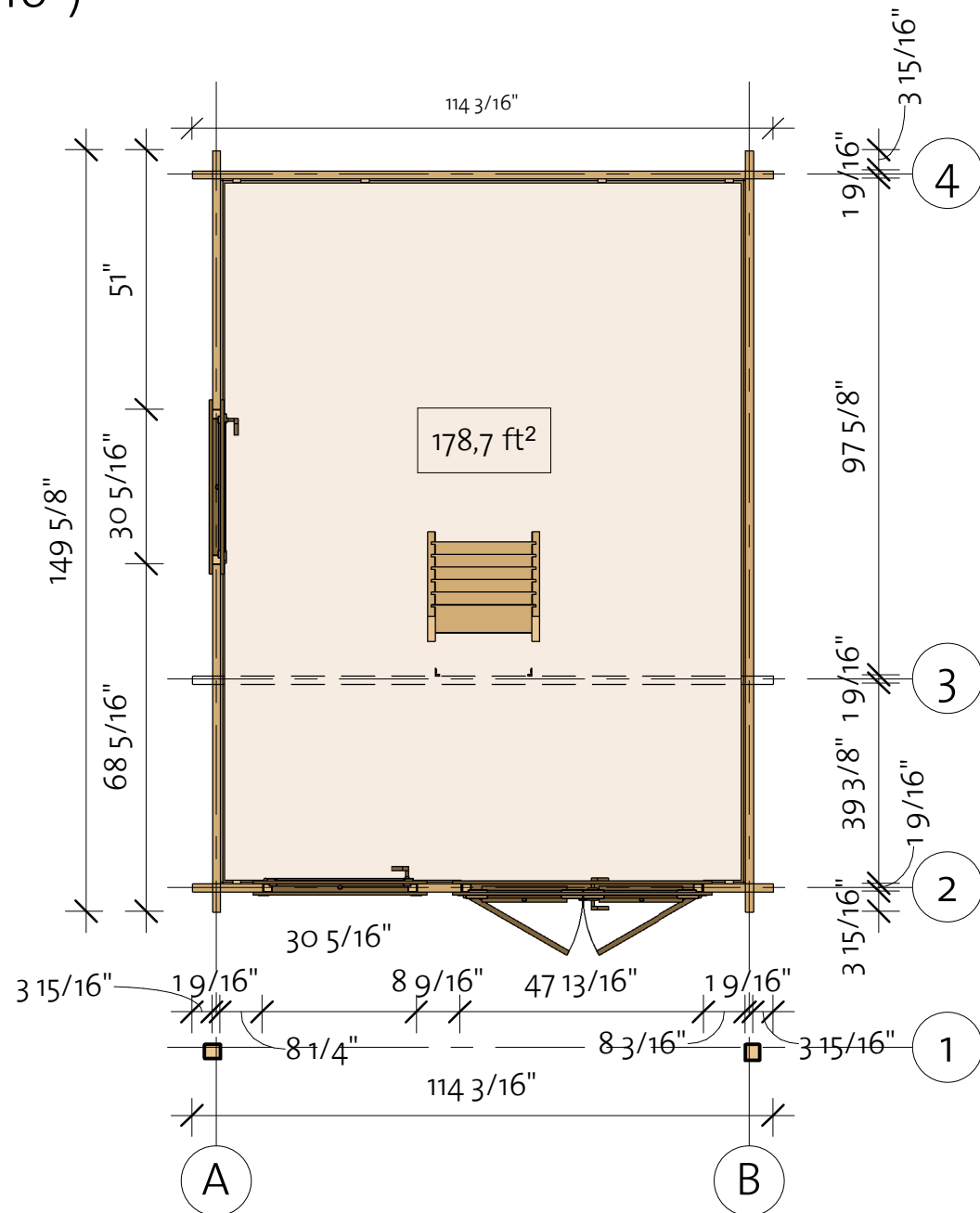

Ontario Bunkie 1 9/16" (10 5/8"x14 3/16")

Wall 1

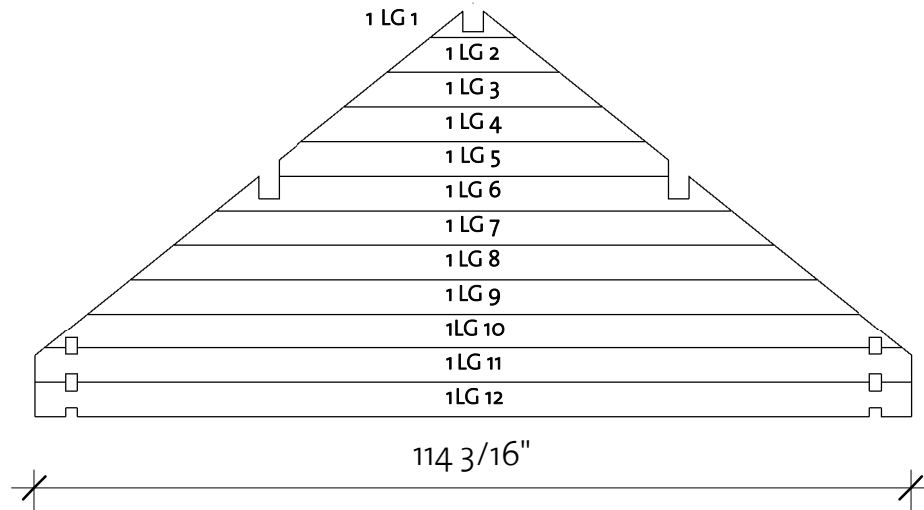
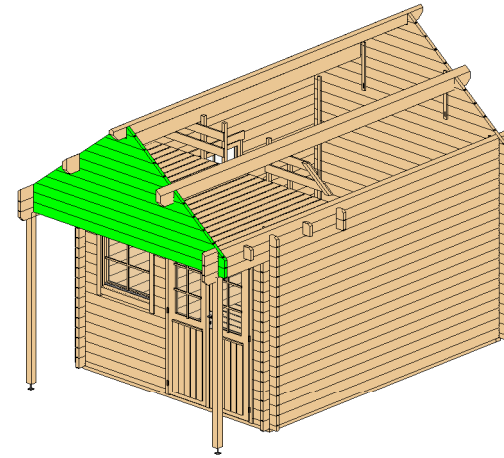

Wall 1			
Mark	Profile	Count	Cut Length

1LG 1 *	40X114	1	11 3/16"
1LG 2 *	40X114	1	22 3/8"
1LG 3 *	40X114	1	33 9/16"
1LG 4 *	40X114	1	44 3/4"
1LG 5 *	40X114	1	50 5/8"
1LG 6 *	40X114	1	67 1/16"
1LG 7 *	40X114	1	78 1/4"
1LG 8 *	40X114	1	89 7/16"
1LG 9 *	40X114	1	100 5/8"
1LG 10 *	40X114	1	111 3/4"
1LG 11	40X114	1	114 3/16"
1LG 12	40X114	1	114 3/16"

* Gable - delivered premounted

Log Profile Wall 1	
Profile	Profile

40X114	
--------	--

Ontario Bunkie 1 9/16" (10 5/8"x14 3/16")

Wall 2

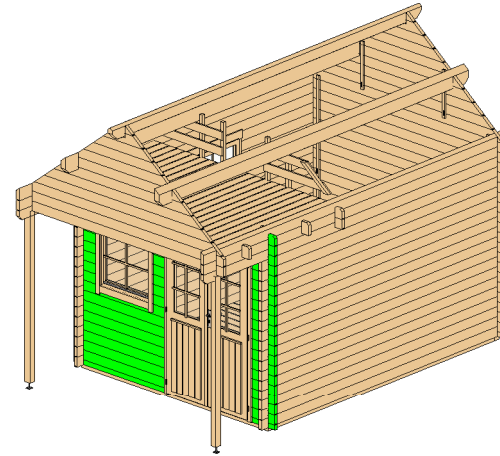

Wall 2			
Mark	Profile	Count	Cut Length

2BL 1	40X57	1	13 3/4"
2BL 2	40X57	1	52 3/4"
2LG 1	40X114	9	8 11/16"
2LG 2	40X114	26	13 3/4"
2LG 3	40X114	8	52 3/4"
2LG 4	40X114	1	114 3/16"
2LG 5	40X114	1	114 3/16"

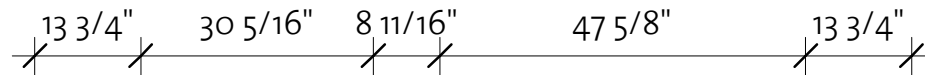
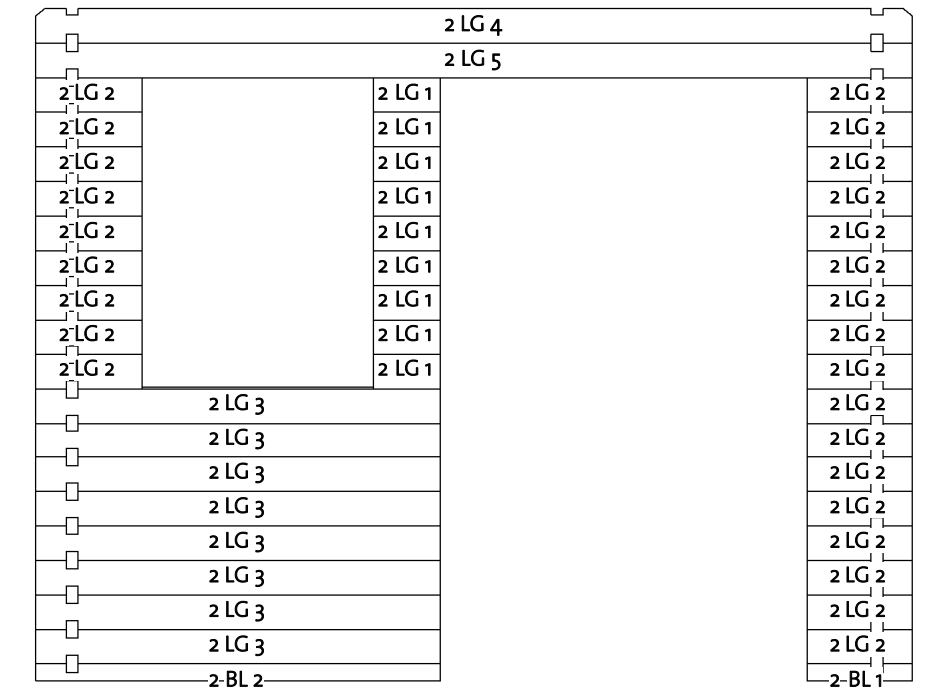

Log Profile Wall 2	
Profile	Images4

40X57	
40X114	
40X114	

Ontario Bunkie 1 9/16" (10 5/8"x14 3/16")

Wall 3

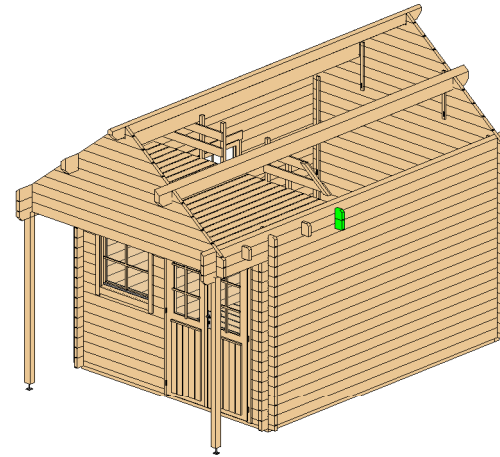

Wall 3			
Mark	Profile	Count	Cut Length

3LG 1	4OX114	1	114 3/16"
3LG 2	4OX114	1	114 3/16"

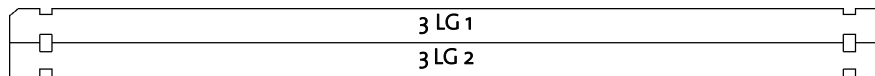

Log Profile Wall 3	
Profile	Images4

4OX114	
4OX114	

Ontario Bunkie 1 9/16" (10 5/8"x14 3/16")

Wall 4

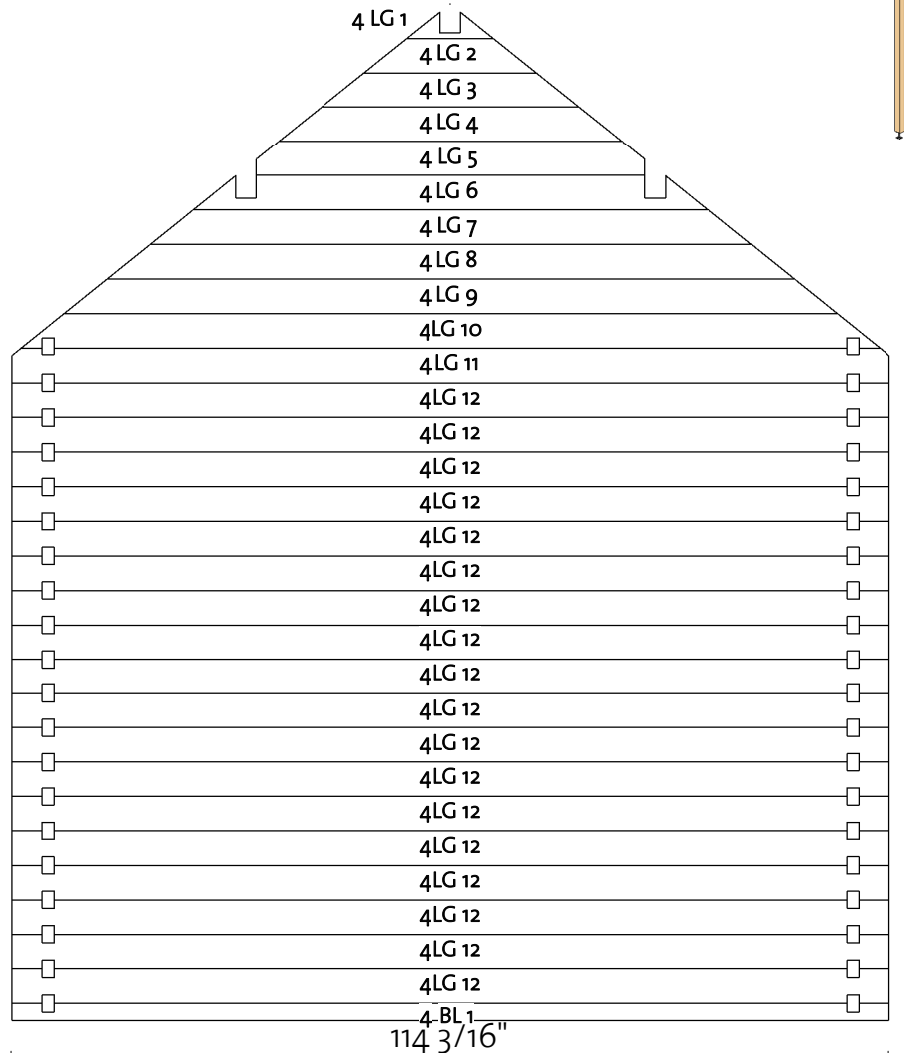
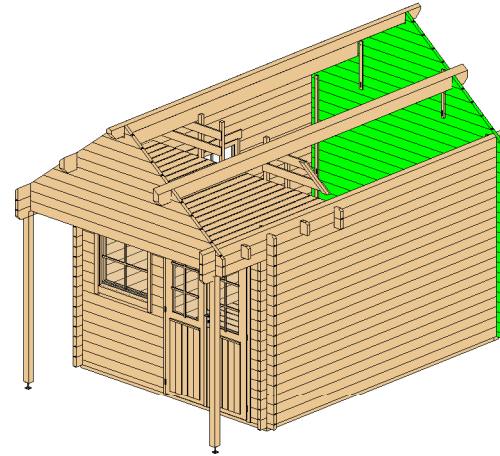

Wall 4			
Mark	Profile	Count	Cut Length

4BL 1	40X57	1	114 3/16"
4LG 1 *	40X114	1	11 3/16"
4LG 2 *	40X114	1	22 3/8"
4LG 3 *	40X114	1	33 9/16"
4LG 4 *	40X114	1	44 3/4"
4LG 5 *	40X114	1	50 5/8"
4LG 6 *	40X114	1	67 1/16"
4LG 7 *	40X114	1	78 1/4"
4LG 8 *	40X114	1	89 7/16"
4LG 9 *	40X114	1	100 5/8"
4LG 10 *	40X114	1	111 3/4"
4LG 11	40X114	1	114 3/16"
4LG 12	40X114	18	114 3/16"

* Gable - delivered premounted

Log Profile Wall 4	
Profile	Profile

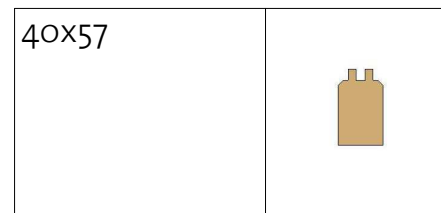

Log Profile Wall 4	
Profile	Profile

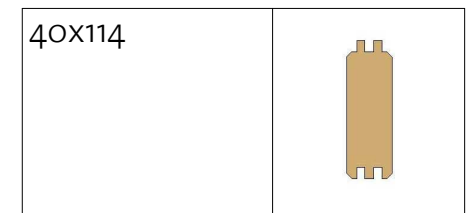

Ontario Bunkie 1 9/16" (10 5/8" x 14 3/16")

Wall A

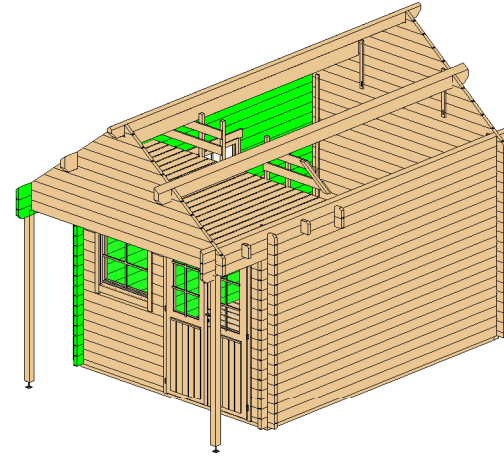

Wall A			
Mark	Profile	Count	Cut Length

ALG 1	40x114	9	51"
ALG 2	40x114	9	68 5/16"
ALG 3	40x114	8	149 5/8"
ALG 4	40x114	1	185 1/16"
ALG 5	40x114	1	189"
ATL 1	40x145	1	189"

39 3/8"

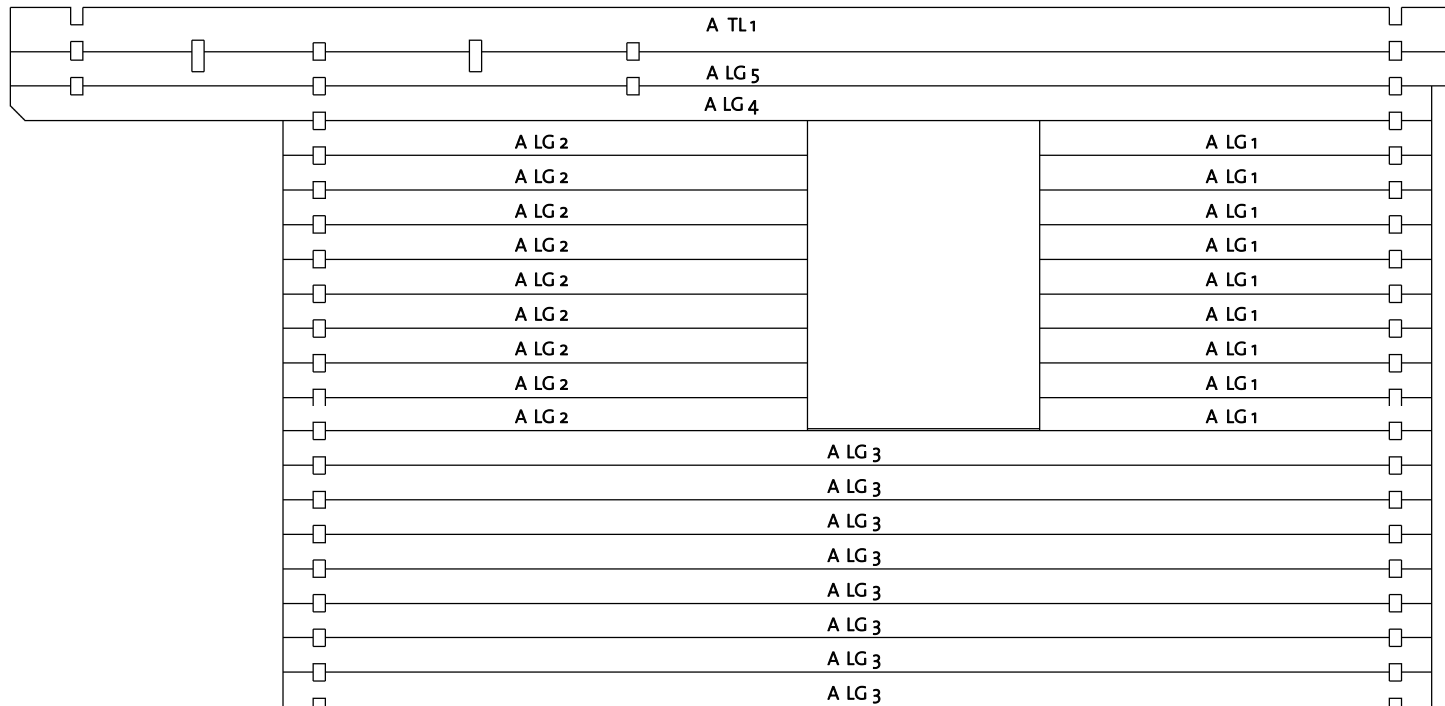

35 7/16" 68 5/16" 30 5/16" 51" 3 15/16"

Log Profile Wall A	
Profile	Profile

40x114	
40x145	

Ontario Bunkie 1 9/16" (10 5/8" x 14 3/16")

Wall B

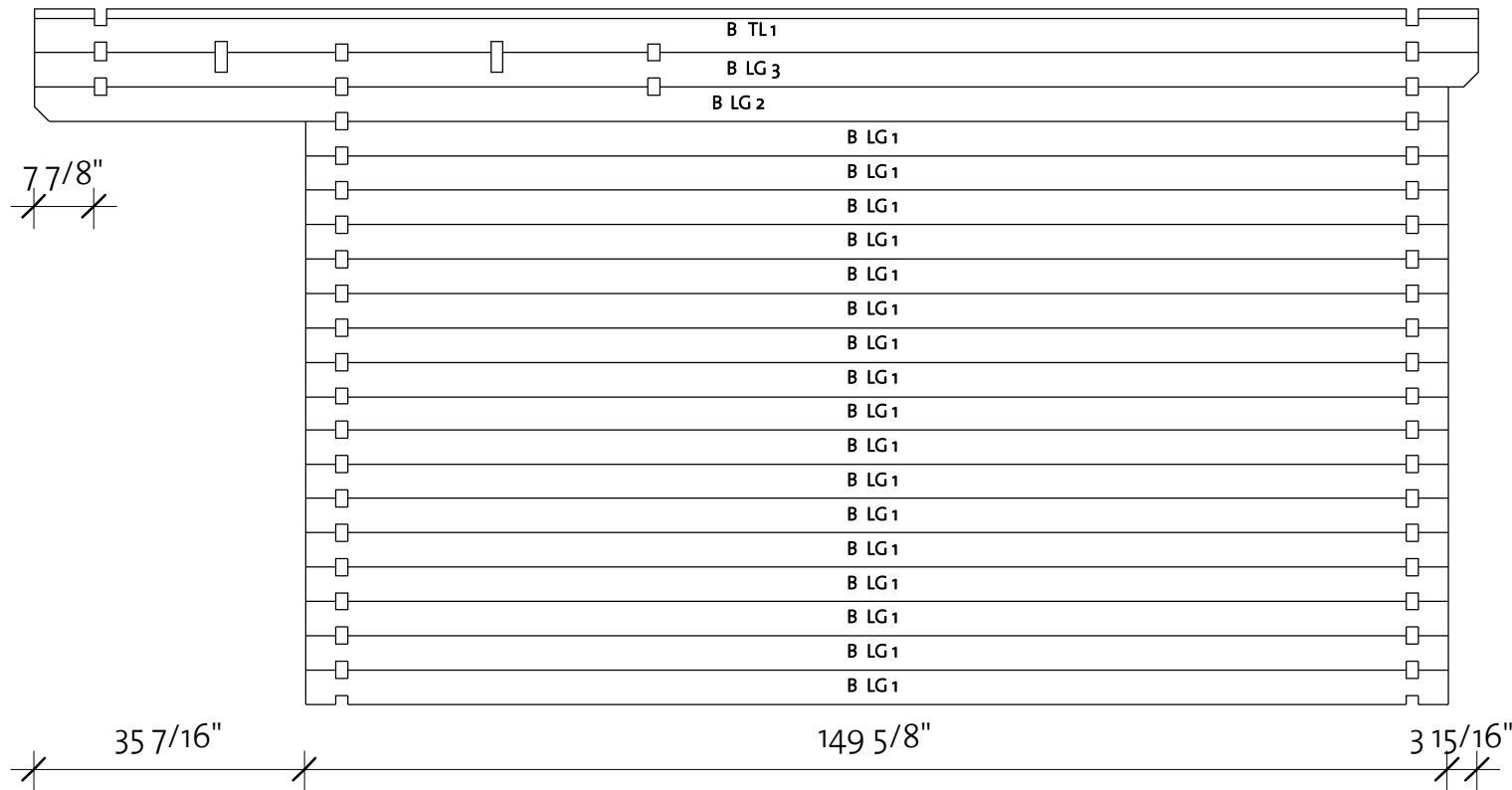
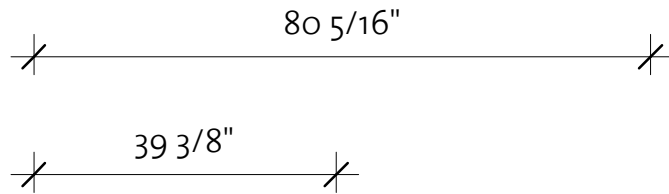
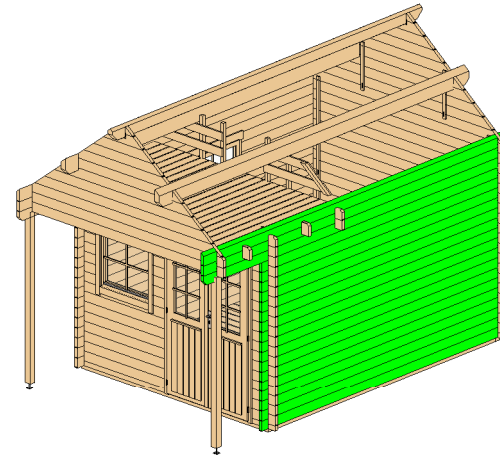

Wall B			
Mark	Profile	Count	Cut Length

BLG 1	40X114	17	149 5/8"
BLG 2	40X114	1	185 1/16"
BLG 3	40X114	1	189"
BTL 1	40X145	1	189"

Log Profile Wall B	
Profile	Profile

40X114	
40X145	

Ontario Bunkie 1 9/16" (10 5/8" x 14 3/16")

Second floor

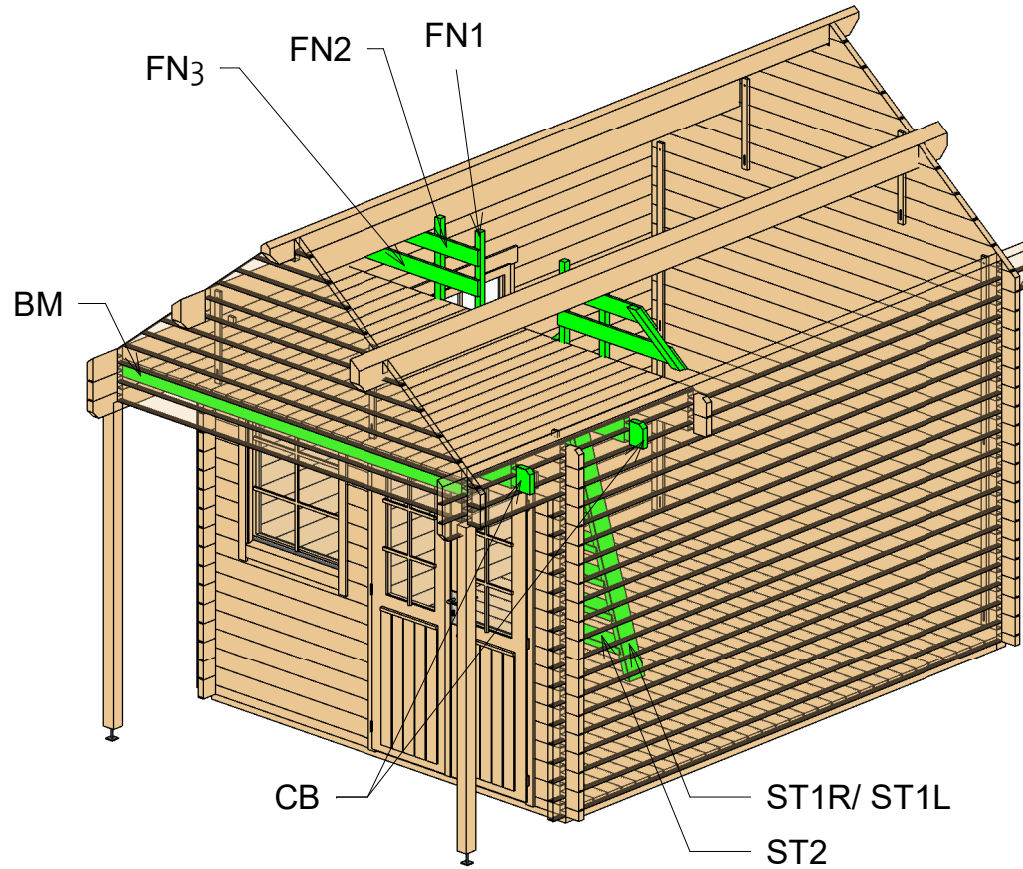

Second floor				
Mark	Type	Profile	Count	Cut Length
FN3	Fence3 18x95		2	38 1/8"
BM	Beam 40x90		1	103 1/8"
CB	Ceiling beam 40x143		2	114 3/16"
FN1	Fence1 38x38		6	26 3/4"
FN2	Fence2 18x95		2	29 1/4"
ST1L	Stair 40x120 L		1	91 7/8"
ST1R	Stair 40x120 R		1	91 7/8"
ST2	Stair 143x40		9	20 1/2"

Ontario Bunkie 1 9/16" (10 5/8" x 14 3/16")

Stair

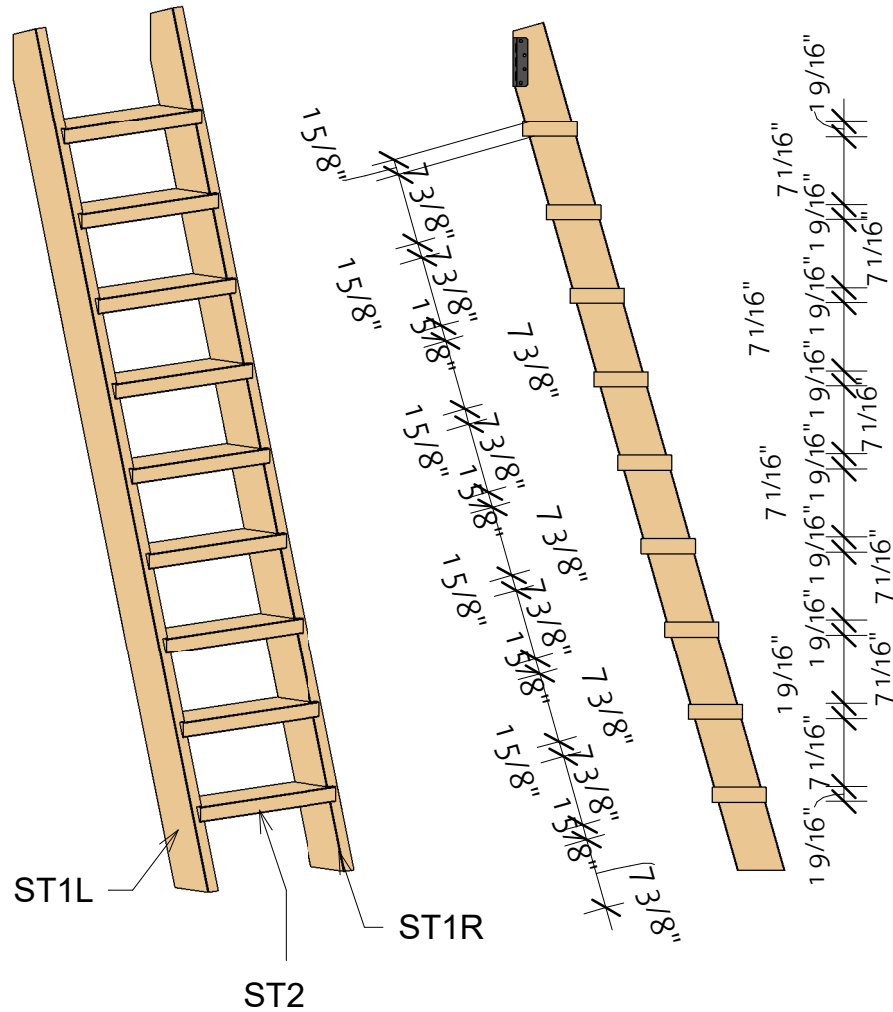

Stairs				
Mark	Profile	Profile	Count	Cut Length
ST1L	40X120		1	91 7/8"
ST1R	40X120		1	91 7/8"
ST2	143X40		9	20 1/2"

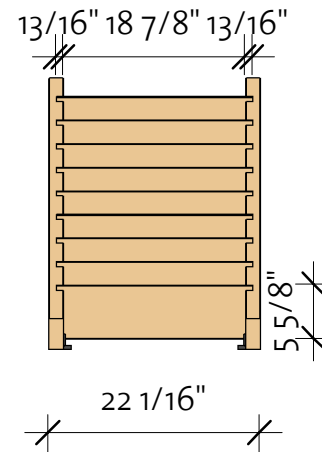

Ontario Bunkie 1 9/16" (10 5/8"x14 3/16")

Roof 1

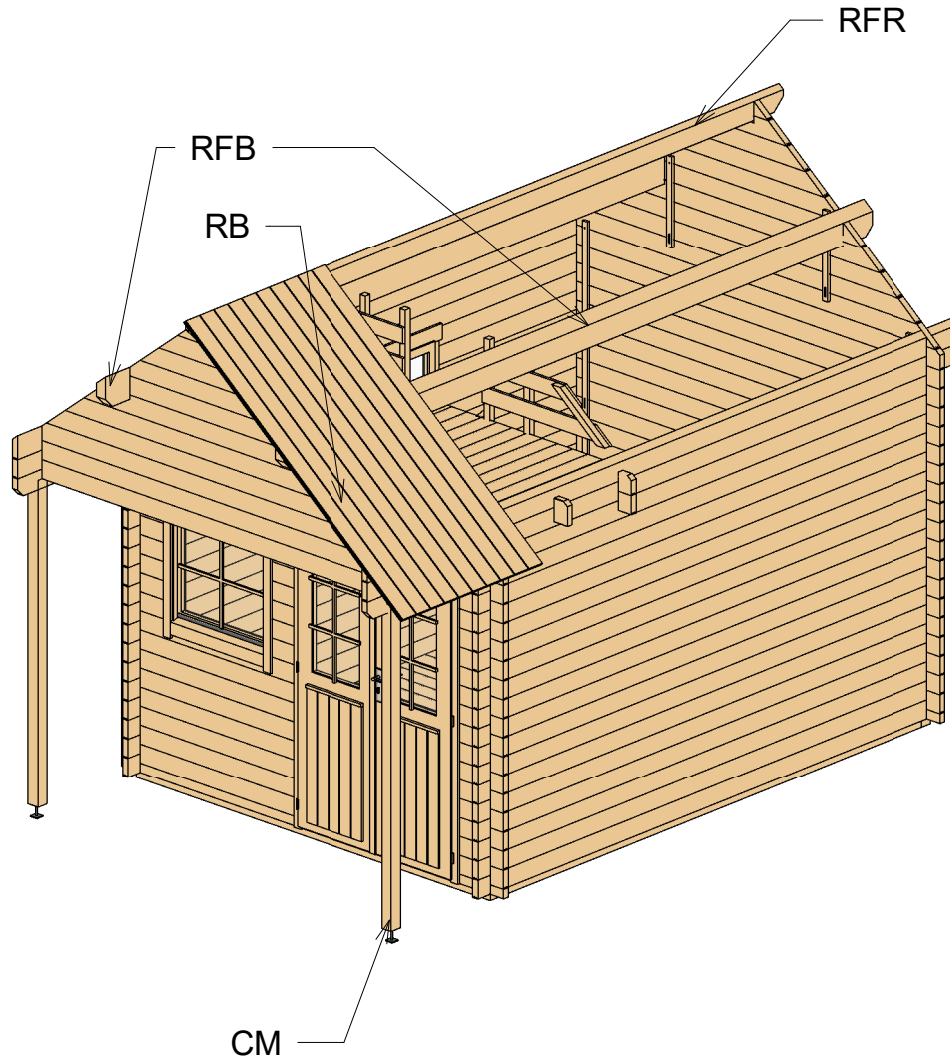

Roof				
Mark	Type	Profile	Count	Length

RFR	Ridge 68x143		1	189"
RFB	Beam 68x193		2	189"
RB	17x114		86	83 7/16"

Post			
Mark	Profile	Count	Length

CM	Post 80x70	2	77 3/16"
----	------------	---	----------

Ontario Bunkie 1 9/16" (10 5/8" x 14 3/16")

Roof 2

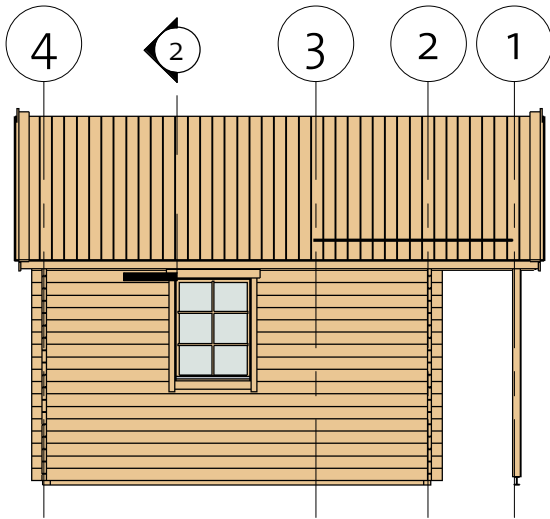

② Facia

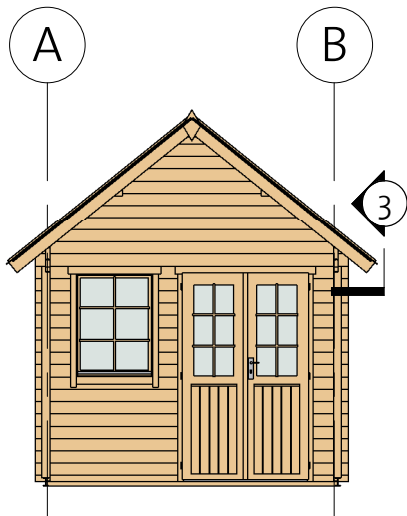
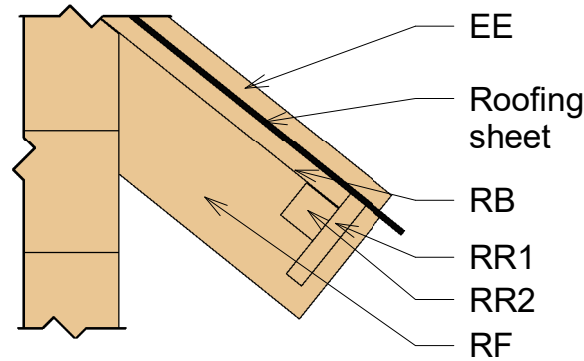

③ Roof Reinforcement

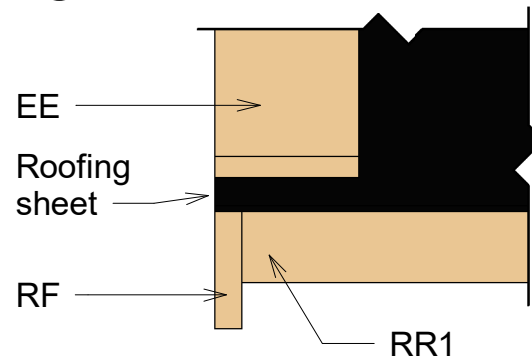

Fascia Schedule

Mark	Type	Profile	Count	Length
EE	Eave Edging 18x95		4	85 7/16"
RF	Roof Fascia 18x120		4	85 7/16"
RR1	Roof reinforcement 18x95		2	189"
RR2	Roof reinforcement 38x38		2	189"

Ontario Bunkie 1 9/16" (10 5/8"x14 3/16")

Fence

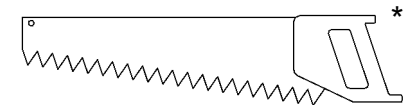
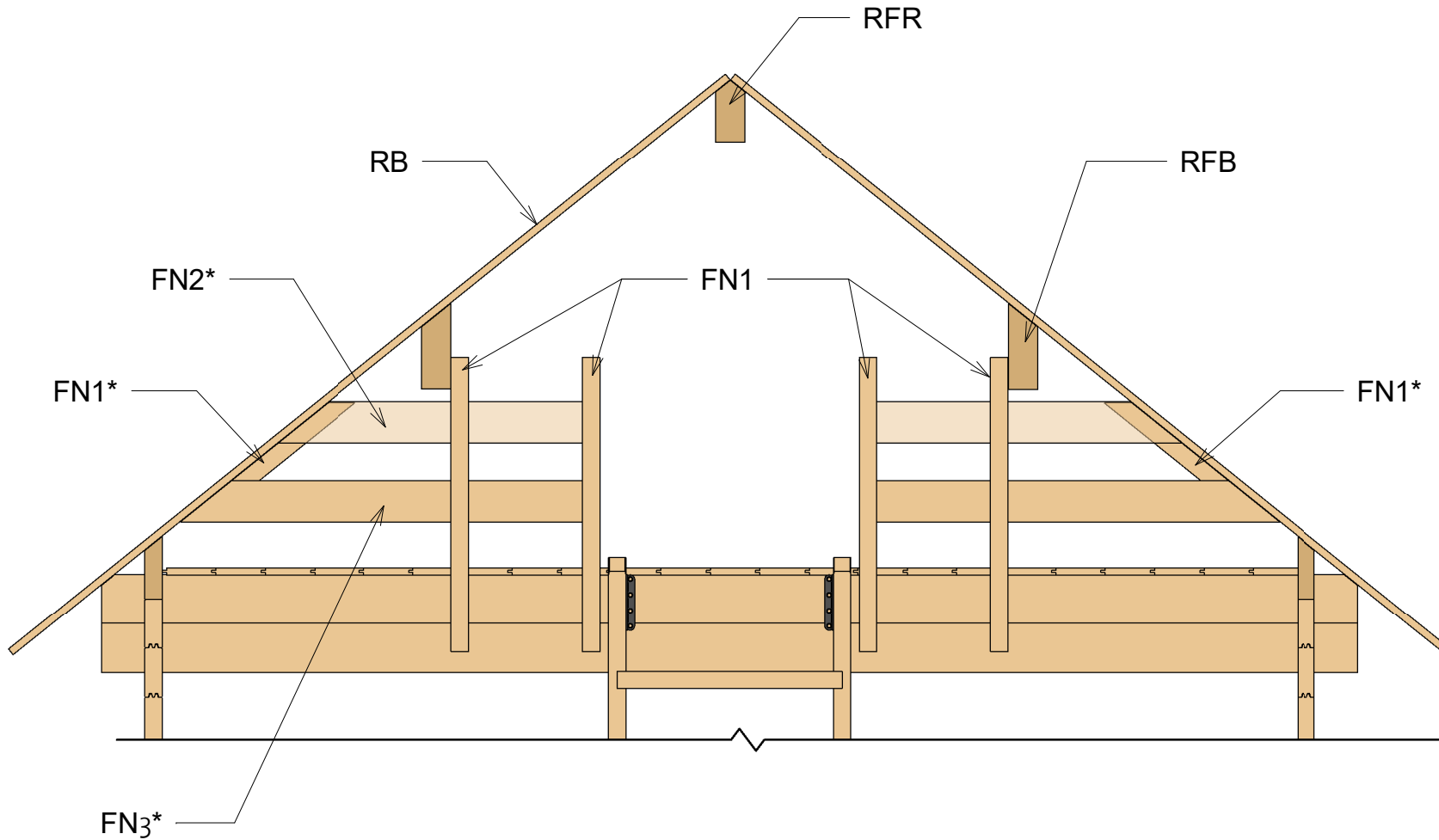

Ontario Bunkie 1 9/16" (10 5/8" x 14 3/16")

Extras

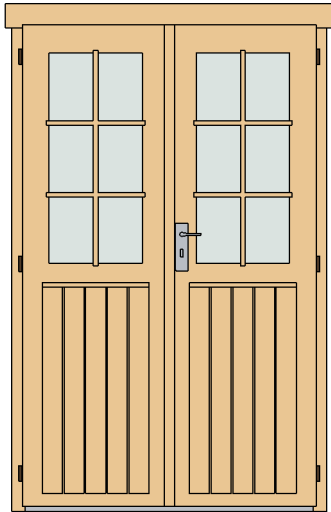

Door Schedule				
Model	Type	Width	Height	Count
CDD5R	Classic double door 5 right	47 1/4"	76 15/16"	1
DCB6-5	Door Crossbar 6-5	--	--	2

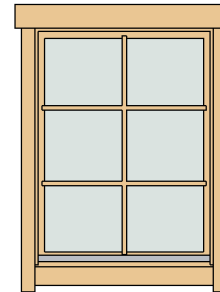

Window Schedule				
Model	Type	Width	Height	Count
CW1R	Classic window 1 right	30 1/8"	39"	2
WCB6	Windows Crossbar 6	--	--	2

Fasteners & Extras		
Name	Type	Count

Hitblock	11 13/16" - 15 3/4"	
Ladder fittings		2
Screws	1/4" x 6 5/16"	6
Bolts	M5/16" x 2 3/4"	20
Screws	3/16" x 2 3/4"	45
Nails	1/16" x 1 9/16"	50
Screws	1/4" x 5 1/2"	80
Screws	3/16" x 1 9/16"	120
Screws	3/16" x 2"	700

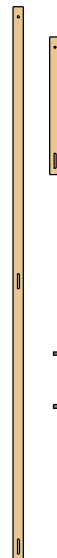

Type	Count	Length
Adjustable post foot	2	2 15/16"
Windboard1 18x40	4	86 5/8"
Windboard2 18x40	4	21 5/8"

Family	Count
Romb	2





Ontario Bunkie 1 9/16" (10 5/8"x14 3/16")

List of all items 1

Impregnated foundation beams



Mark	Type	Profile	Count	Length
------	------	---------	-------	--------

IFB1	IFB 70x40		6	135 13/16"
IFB2	IFB 70x40		2	105 7/8"

BB	BB 20x40		5	3800
----	-------------	---	---	------



Floor Schedule

Mark	Type	Profile	Count	Length
------	------	---------	-------	--------

FB1	FB 17x114		32	103 1/16"
FB2	FB 17x114		24	72 13/16"



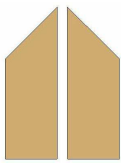

Roof

Mark	Type	Profile	Count	Length
------	------	---------	-------	--------

RFR	Ridge 68x143		1	189"
RFB	Beam 68x193		2	189"
RB	17x114		86	83 7/16"

Fascia Schedule

Mark	Type	Profile	Count	Length
------	------	---------	-------	--------

EE	Eave Edging 18x95		4	85 7/16"
RF	Roof Fascia 18x120		4	85 7/16"
RR1	Roof reinforcement 18x95		2	189"
RR2	Roof reinforcement 38x38		2	189"

Ontario Bunkie 1 9/16" (10 5/8"x14 3/16")

List of all items 2

Wall 1			
Mark	Profile	Count	Cut Length

1LG 1 *	40X114	1	11 3/16"
1LG 2 *	40X114	1	22 3/8"
1LG 3 *	40X114	1	33 9/16"
1LG 4 *	40X114	1	44 3/4"
1LG 5 *	40X114	1	50 5/8"
1LG 6 *	40X114	1	67 1/16"
1LG 7 *	40X114	1	78 1/4"
1LG 8 *	40X114	1	89 7/16"
1LG 9 *	40X114	1	100 5/8"
1LG 10 *	40X114	1	111 3/4"
1LG 11	40X114	1	114 3/16"
1LG 12	40X114	1	114 3/16"

Wall 4			
Mark	Profile	Count	Cut Length

4BL 1	40X57	1	114 3/16"
4LG 1 *	40X114	1	11 3/16"
4LG 2 *	40X114	1	22 3/8"
4LG 3 *	40X114	1	33 9/16"
4LG 4 *	40X114	1	44 3/4"
4LG 5 *	40X114	1	50 5/8"
4LG 6 *	40X114	1	67 1/16"
4LG 7 *	40X114	1	78 1/4"
4LG 8 *	40X114	1	89 7/16"
4LG 9 *	40X114	1	100 5/8"
4LG 10 *	40X114	1	111 3/4"
4LG 11	40X114	1	114 3/16"
4LG 12	40X114	18	114 3/16"

Wall 2			
Mark	Profile	Count	Cut Length



2BL 1	40X57	1	13 3/4"
2BL 2	40X57	1	52 3/4"
2LG 1	40X114	9	8 11/16"
2LG 2	40X114	26	13 3/4"
2LG 3	40X114	8	52 3/4"
2LG 4	40X114	1	114 3/16"
2LG 5	40X114	1	114 3/16"

Wall 3			
Mark	Profile	Count	Cut Length

3LG 1	40X114	1	114 3/16"
3LG 2	40X114	1	114 3/16"

*Gable-delivered premounted

Log Profiles 1	
Profile	Profile

40X57	
40X114	
40X114	

Ontario Bunkie 1 9/16" (10 5/8"x14 3/16")

List of all items 3

Wall A			
Mark	Profile	Count	Cut Length

ALG 1	40X114	9	51"
ALG 2	40X114	9	68 5/16"
ALG 3	40X114	8	149 5/8"
ALG 4	40X114	1	185 1/16"
ALG 5	40X114	1	189"
ATL 1	40X145	1	189"

Wall B			
Mark	Profile	Count	Cut Length





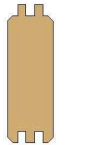
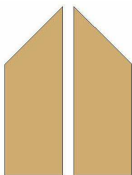





BLG 1	40X114	17	149 5/8"
BLG 2	40X114	1	185 1/16"
BLG 3	40X114	1	189"
BTL 1	40X145	1	189"

Log Profiles 2	
Profile	Profile

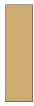
40X114	
40X145	

Ontario Bunkie 1 9/16" (10 5/8"x14 3/16")

List of all items 4

Second floor					Stairs				
Mark	Type	Profile	Count	Cut Length	Mark	Profile	Profile	Count	Cut Length
FN3	Fence3 18x95		2	38 1/8"	ST1L	40x120		1	91 7/8"
BM	Beam 40x90		1	103 1/8"	ST1R	40x120		1	91 7/8"
CB	Ceiling beam 40x143		2	114 3/16"	ST2	143x40		9	20 1/2"
FN1	Fence1 38x38		6	26 3/4"					
FN2	Fence2 18x95		2	29 1/4"					
ST1L	Stair 40x120 L		1	91 7/8"					
ST1R	Stair 40x120 R		1	91 7/8"					
ST2	Stair 143x40		9	20 1/2"					

Post			
Mark	Profile	Count	Length
CM	Post 80x70	2	77 3/16"