

Techn. Data: Garage A

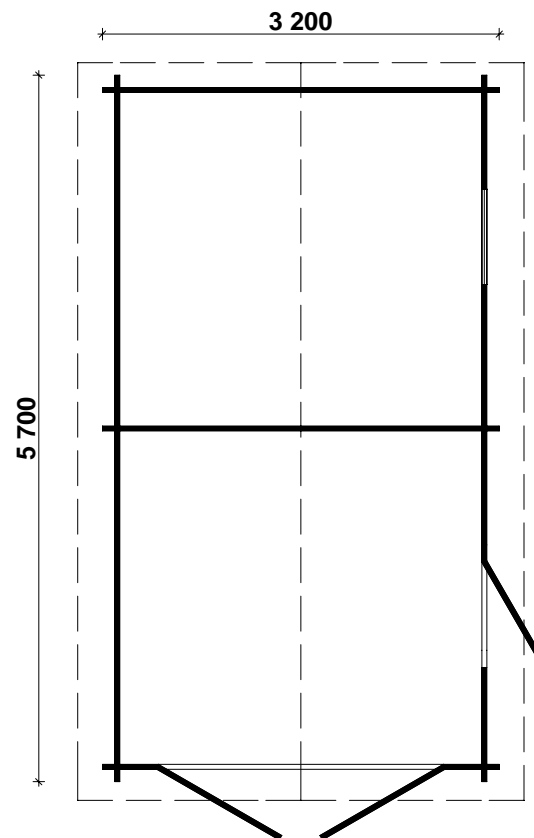

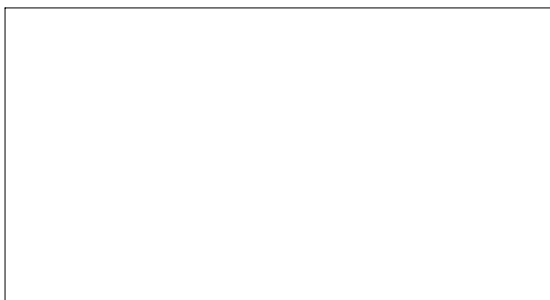

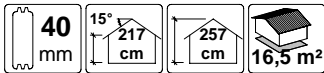







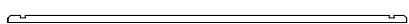
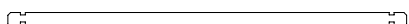
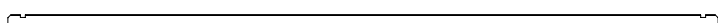
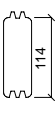

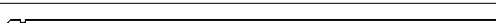
Log length (W x D): 320 x 570 cm

Wall size(outside): 300 x 550 cm - Log thickness: 40 mm

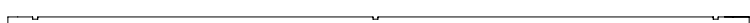
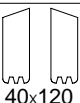

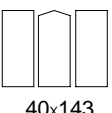
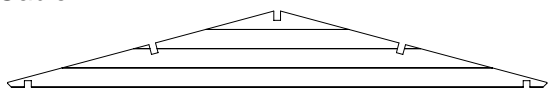
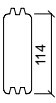
Note: All dimensions are approximate !

Garage A 40 - 320 x 570 cm

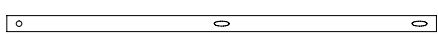
Nr	Description	Profile mm	Length mm	Quantity	
1			410	2	
2			3200	1	
3			3200	20	
4				5700	17
5				5700	2
6				3930	8
7				920	26
8				410	34
9			2240	9	
10		 40x120	5950	2(1+1)	
11	Purlin 	 40x143	5950	3(2+1)	
12	Gable 	 114	3200	3	
13	Door ca. 840 x 1890 mm			1	
14	Double door ca. 2370 x 1955 mm			1	
15	Window ca. 765 x 990 mm			1	
16	Roofing felt			--	
17	Roof board	Vers. 1 >  18x88	2000	136+2	
		Vers. 2 >  18x110	2000	110+2	
18	Facia board 	18x110	2034	4	
19	Eave edging	16x35	2034	4	
20	Roof edge reinforcement	18x90	2975	4	
21	Roof edge reinforcement	28x28	2975	4	
22	Diamond 			2	
23	Screws 4,0 x 40			1 bag	
24	Nails 2,2 x 50			1 bag	
25	Roofing nails 3,0 x 15			--	
26	Storm braces 		2150	4	
27	Bolt M 8 x 70, nut, washer			12	
28	Foundation	28x55	3000/2695	2/4	
29	Hitblock		300-400		

Garage A 40 - 320 x 570 cm

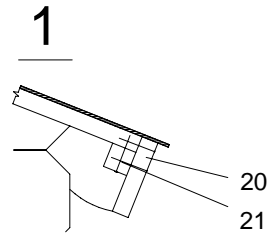
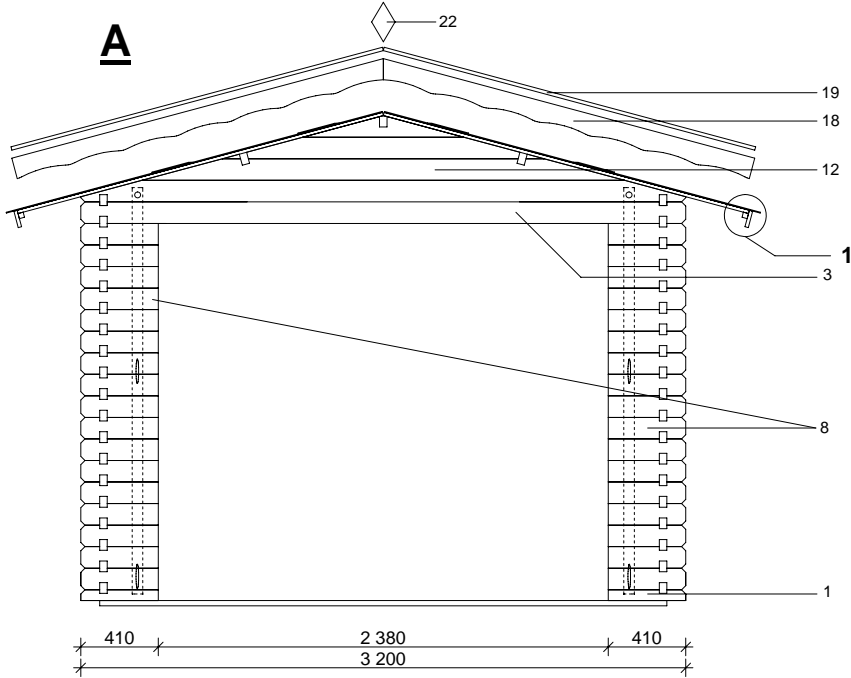

A-A

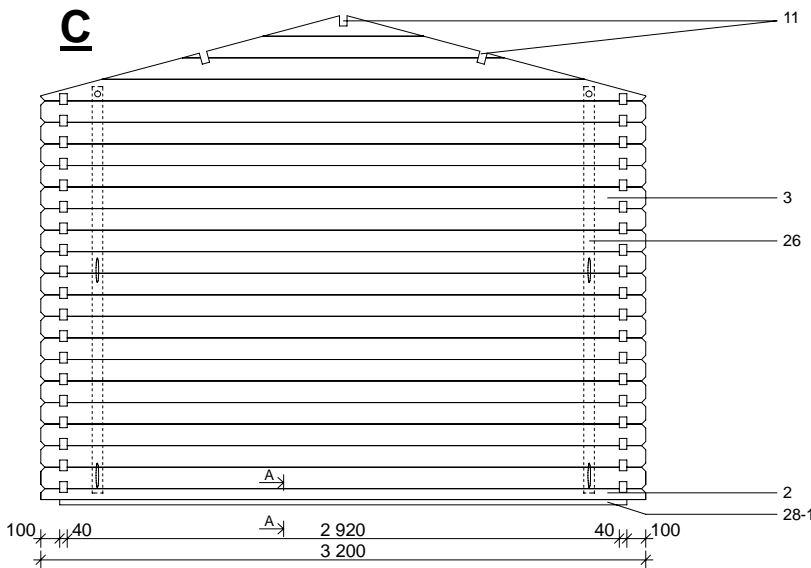
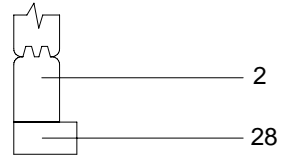

B-B

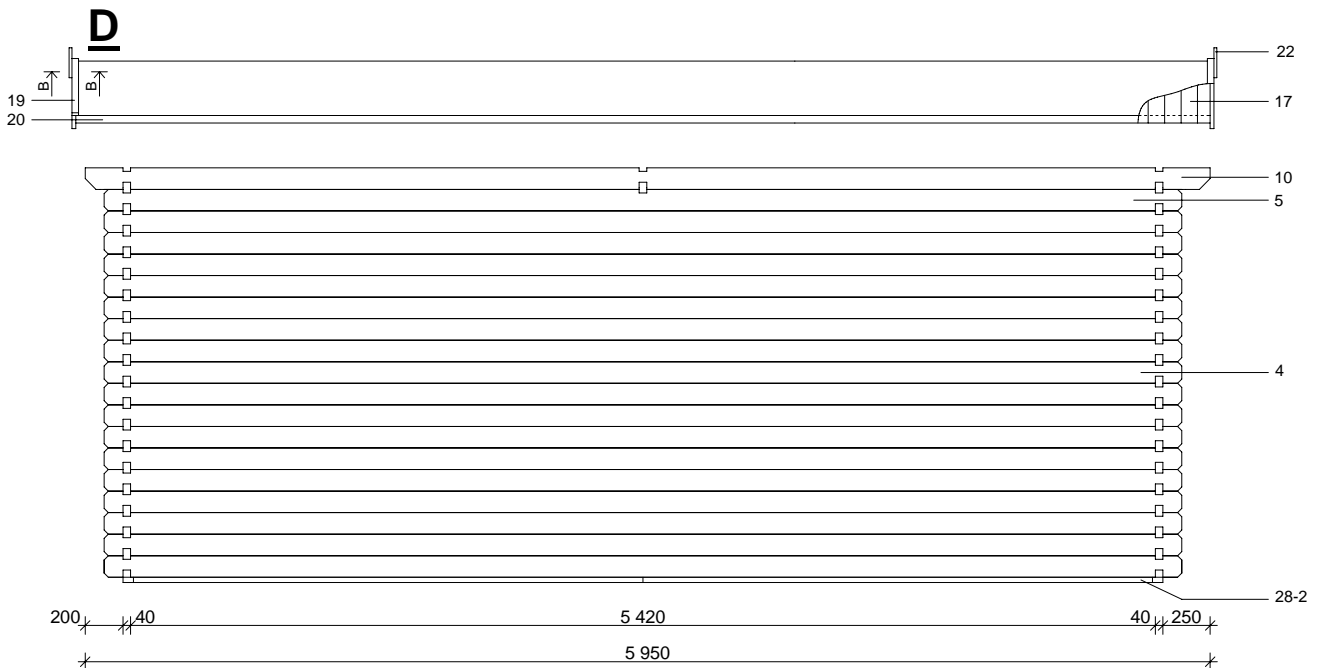
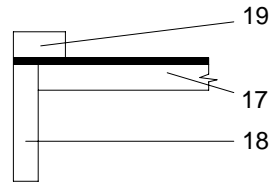

Garage A 40 - 320 x 570 cm

E

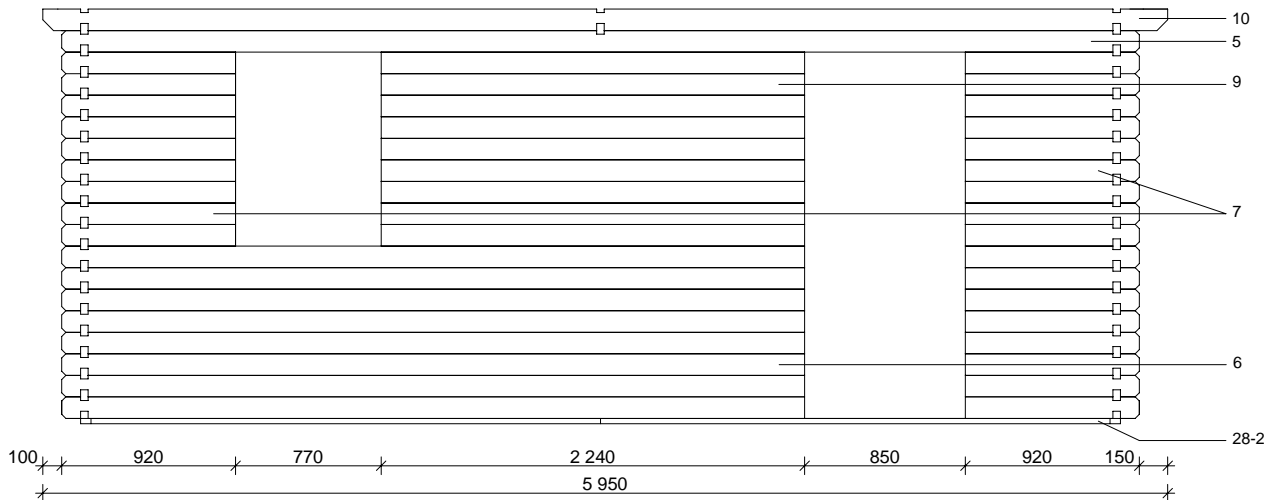

B

