

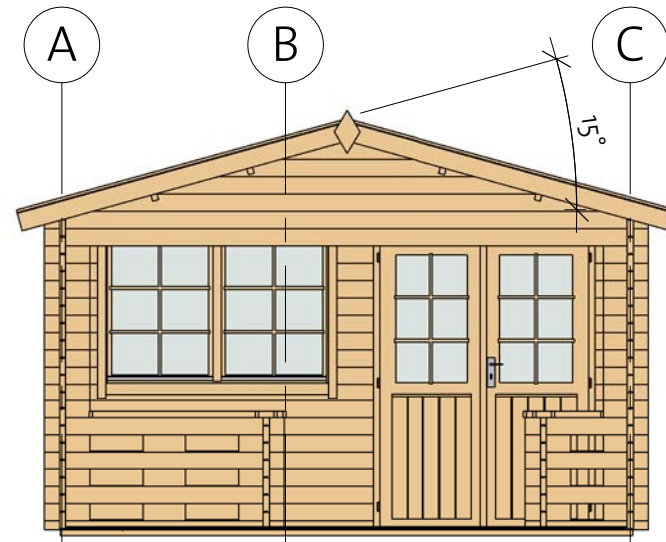

# Johnny 40 (380x480)

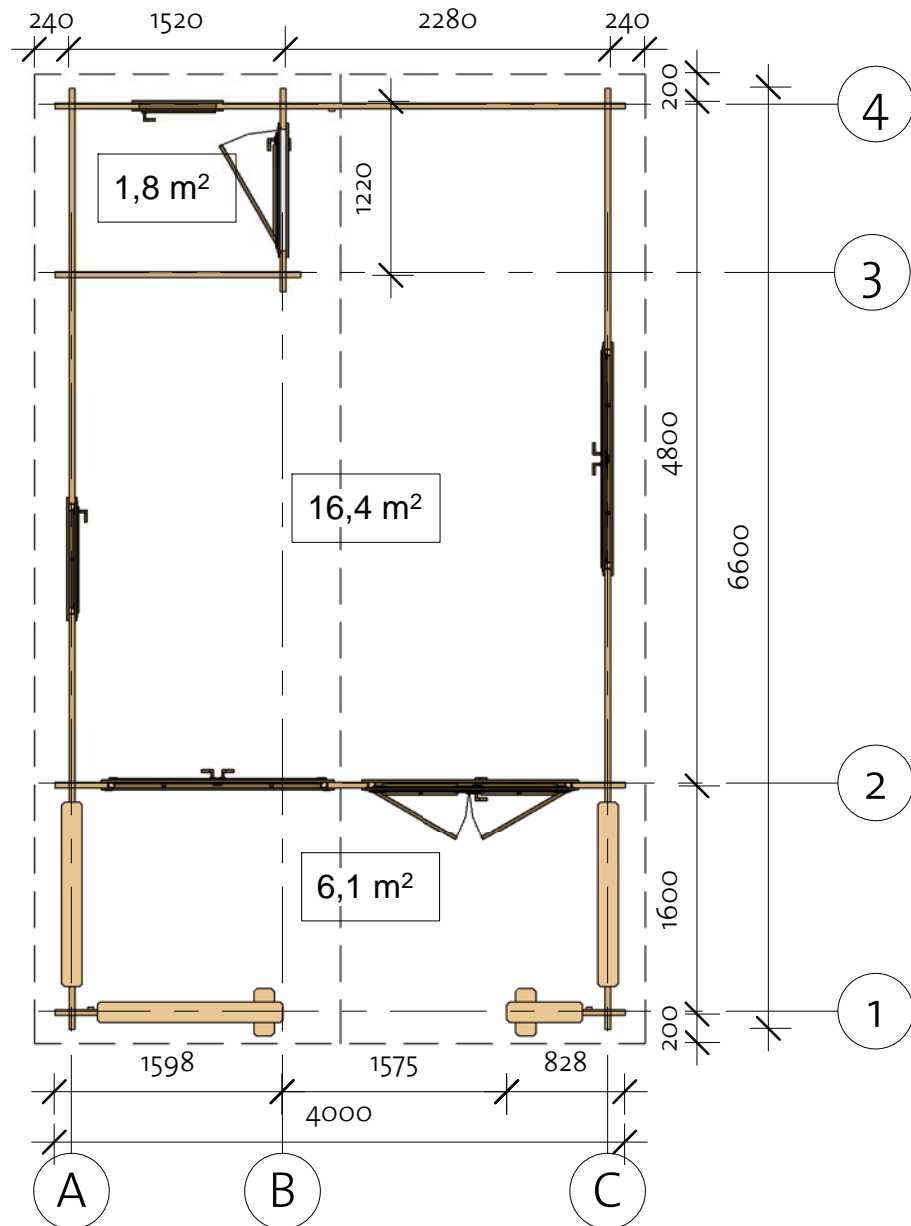
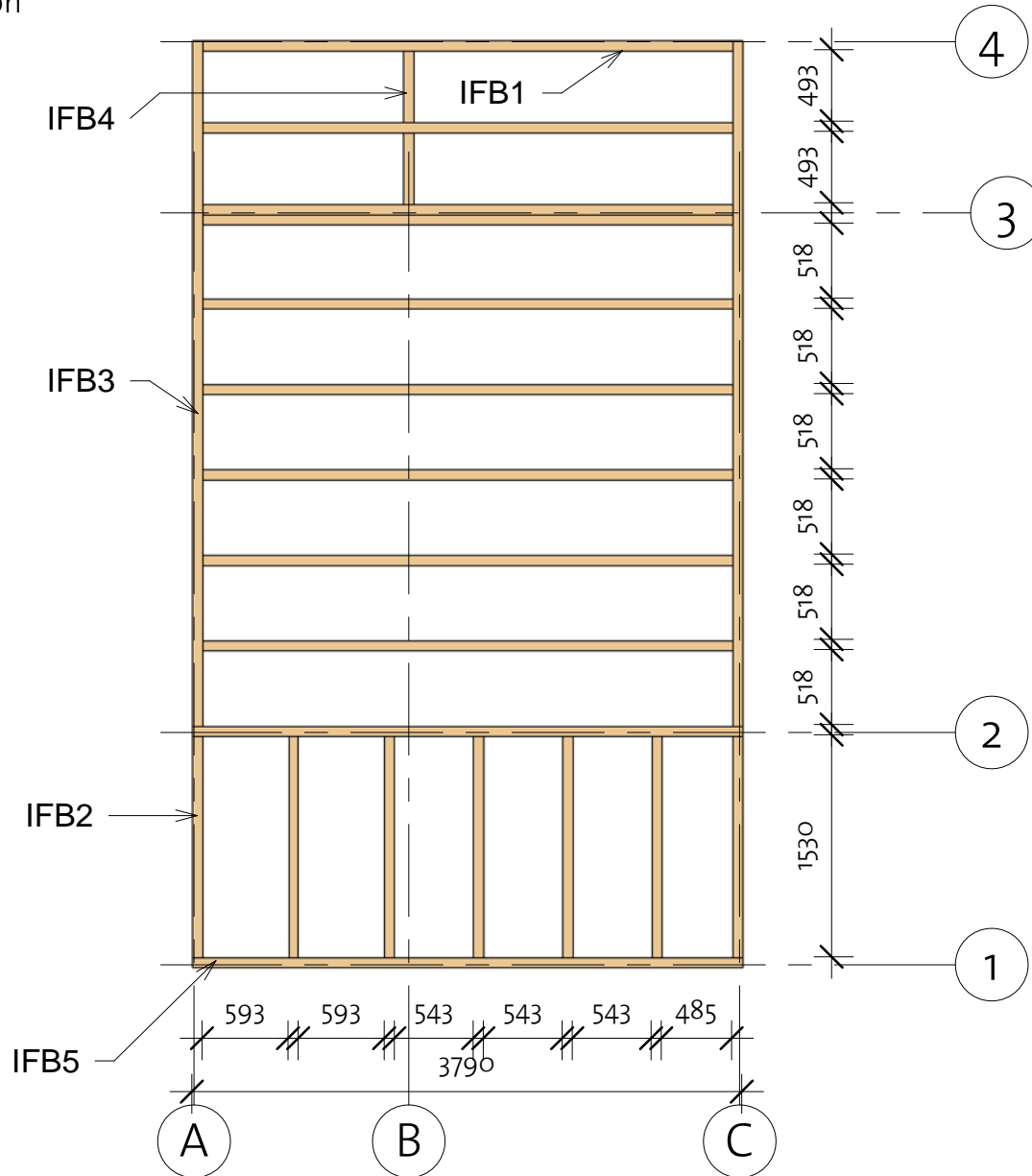

# Johnny 40 (380x480)

Foundation



Impregnated foundation beams				
Mark	Type	Profile	Count	Length
IFB1	IFB 70x40		9	3650
IFB2	IFB 70x40		7	1530
IFB3	IFB 70x40		2	4720
IFB4	IFB 70x40		2	493
IFB5	IFB 70x40		2	3790

# Johnny 40 (380x480)

Floor Plan

Floor Schedule

Mark	Type	Profile	Count	Length
------	------	---------	-------	--------

FB1	FB 18x110		14	1134
-----	-----------	---	----	------

FB2	FB 18x110		15	3534
-----	-----------	--	----	------

FB3	FB 18x110		22	4714
-----	-----------	--	----	------

BB1	BB 18x40		2	3800
-----	----------	---	---	------

BB2	BB 18x40		2	3040
-----	----------	--	---	------

BB3	BB 18x40		2	4800
-----	----------	--	---	------

Terrace Schedule

Mark	Type	Profile	Count	Length
------	------	---------	-------	--------

TB	TB 18x95		18	3714
----	----------	---	----	------

1 Baseboard

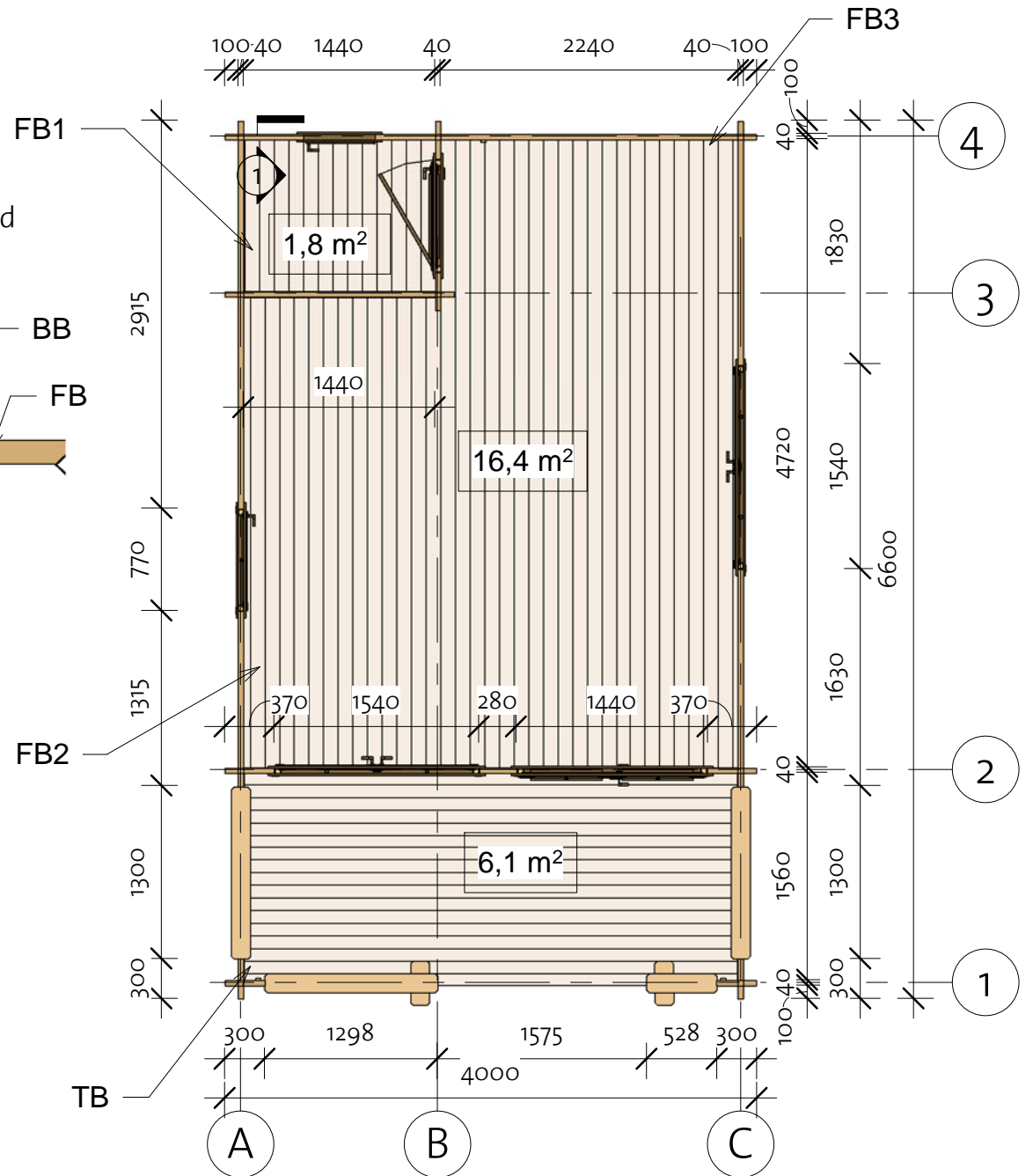
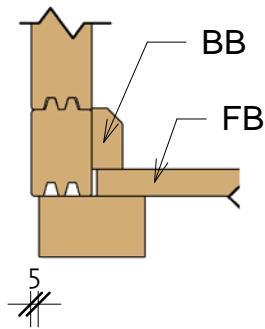

# Johnny 40 (380x480)

Wall 1

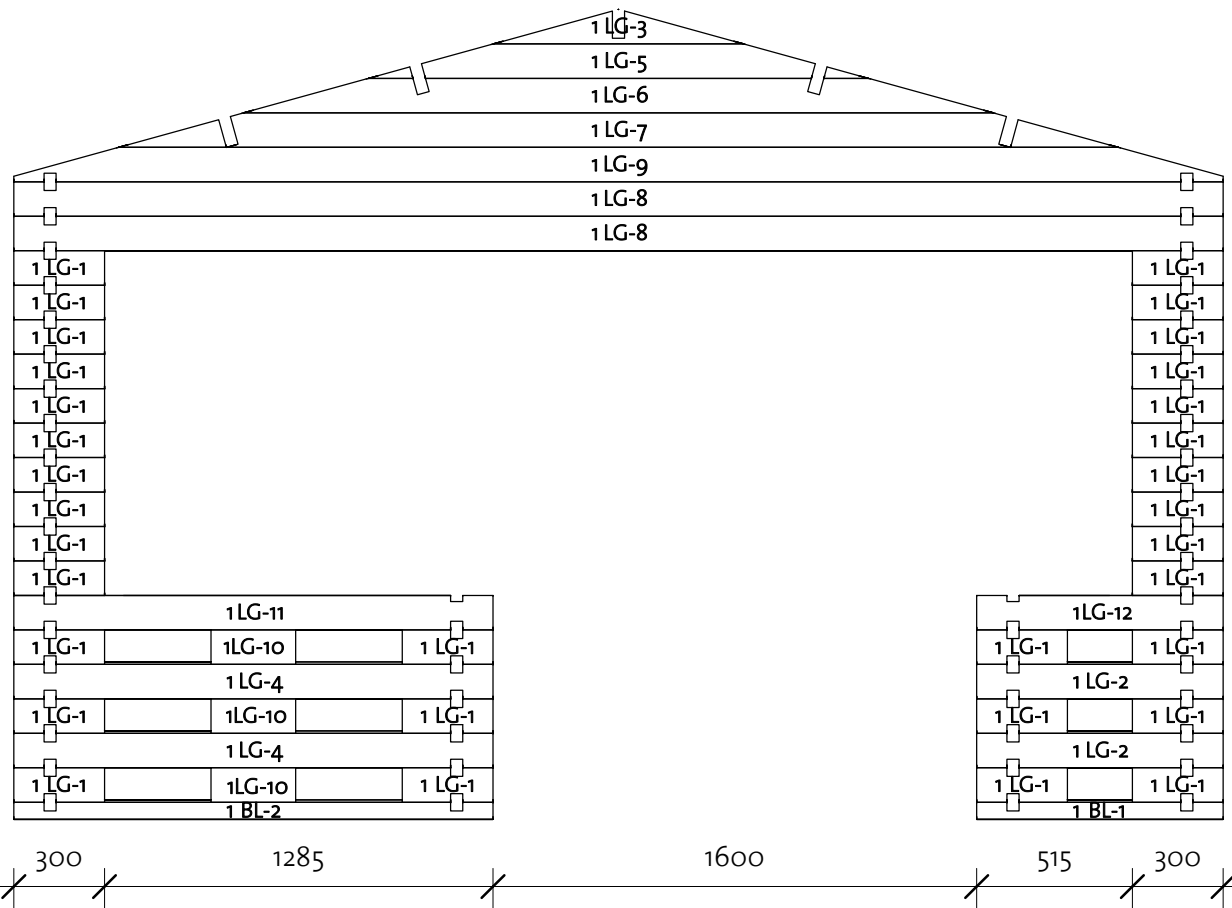
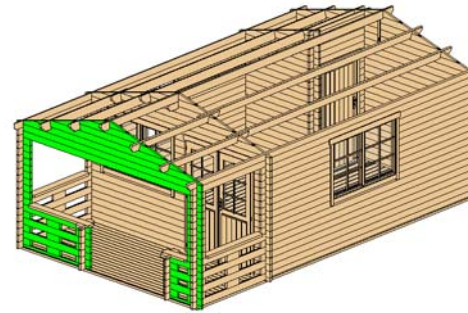



Wall 1			
Mark	Profile	Count	Cut Length

1BL-1	40X57	1	815
1BL-2	40X57	1	1585
1LG-1	40X114	32	300
1LG-2	40X114	2	815
1LG-3*	40X114	1	828
1LG-4	40X114	2	1585
1LG-5*	40X114	1	1654
1LG-6*	40X114	1	2481
1LG-7*	40X114	1	3307
1LG-8	40X114	2	4000
1LG-9*	40X114	1	4000
1LG-10	40X114	3	280
1LG-11	40X114	1	1585
1LG-12	40X114	1	815

\* Gable - delivered premounted

Log Profile Wall 1	
Profile	Profile

40X57	
40X114	

# Johnny 40 (380x480)

Wall 2

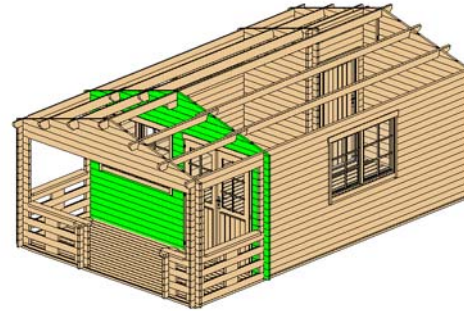



Wall 2			
Mark	Profile	Count	Cut Length

2BL-1	40x57	1	370
2BL-2	40x57	1	2190
2LG-1	40x114	9	280
2LG-2	40x114	26	370
2LG-3*	40x114	1	828
2LG-4*	40x114	1	1654
2LG-5	40x114	8	2190
2LG-6*	40x114	1	2481
2LG-7*	40x114	1	3307
2LG-8	40x114	1	4000
2LG-9*	40x114	1	4000

\* Gable - delivered premounted

Log Profile Wall 2	
Profile	Profile

40x57	
40x114	

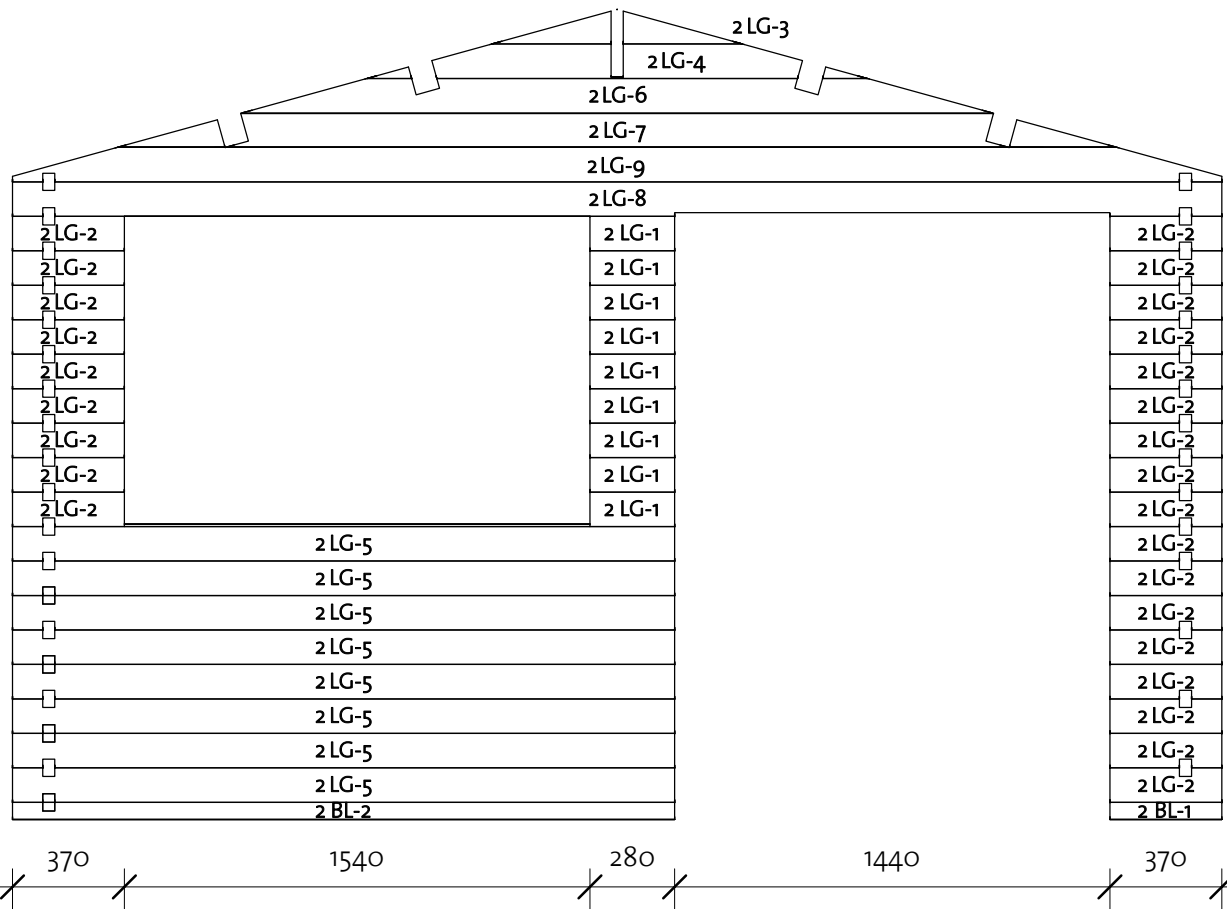

# Johnny 40 (380x480)

Wall 3

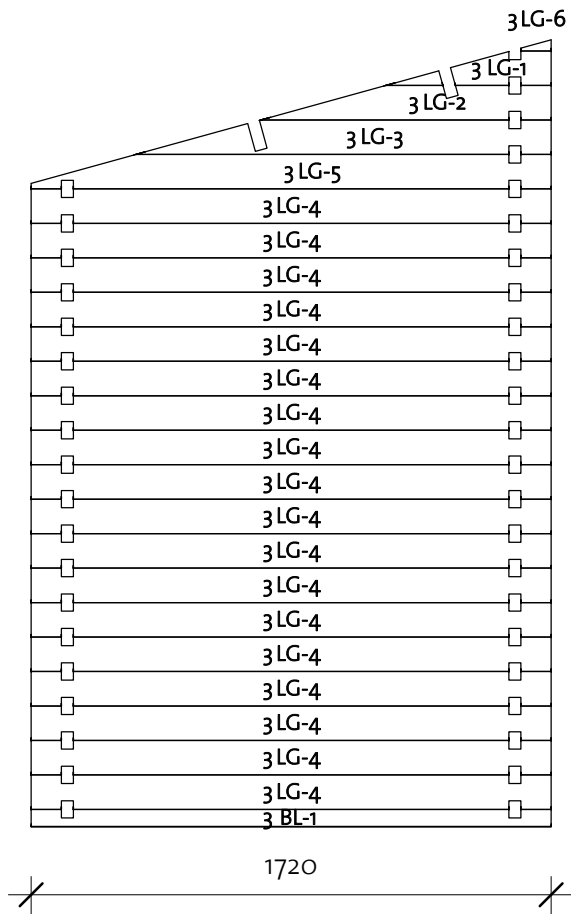
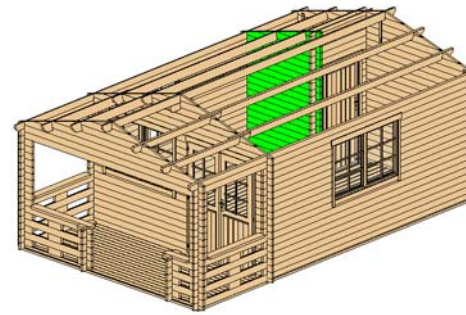

Wall 3			
Mark	Profile	Count	Cut Length

3BL-1	40X57	1	1720
3LG-1	40X114	1	547
3LG-2	40X114	1	960
3LG-3	40X114	1	1373
3LG-4	40X114	18	1720
3LG-5	40X114	1	1720
3LG-6	40X114	1	100

Log Profile Wall 3	
Profile	Profile

40X57	
40X114	

# Johnny 40 (380x480)

Wall 4

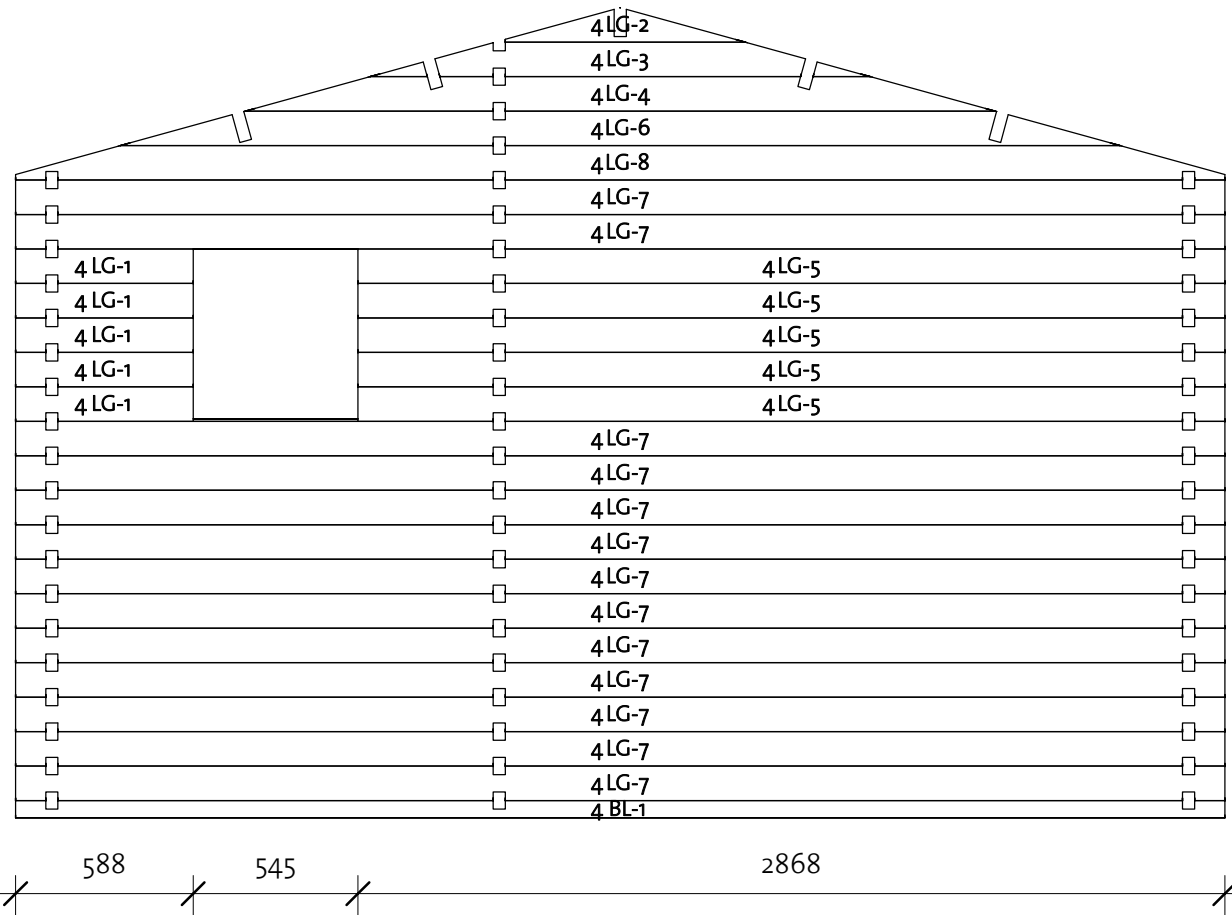
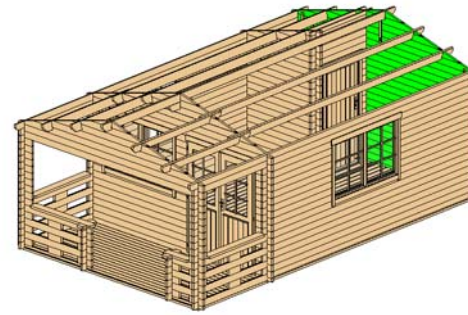

Wall 4			
Mark	Profile	Count	Cut Length

4BL-1	40x57	1	4000
4LG-1	40x114	5	588
4LG-2	40x114	1	794
4LG-3	40x114	1	1654
4LG-4	40x114	1	2481
4LG-5	40x114	5	2868
4LG-6	40x114	1	3307
4LG-7	40x114	13	4000
4LG-8	40x114	1	4000

Log Profile Wall 4	
Profile	Profile

40x57	
40x114	

# Johnny 40 (380x480)

Wall A

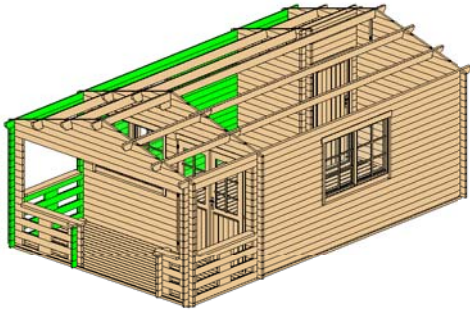

Log Profile Wall A	
Profile	Profile

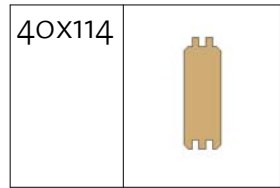

Log Profile Wall A	
Profile	Profile

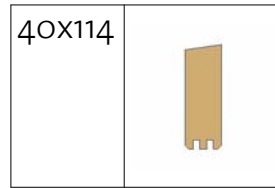

Wall A			
Mark	Profile	Count	Cut Length
ALG-1	40x114	13	300
ALG-2	40x114	3	280
ALG-3	40x114	8	1315
ALG-4	40x114	9	2915
ALG-5	40x114	4	5000
ALG-6	40x114	5	4880

Wall A			
Mark	Profile	Count	Cut Length
ALG-7	40x114	4	1720
ALG-8	40x114	1	1315
ALG-9	40x114	1	1720
ATL-1	40x114	1	1820
ATL-2	40x114	1	4980

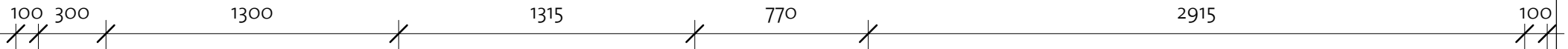
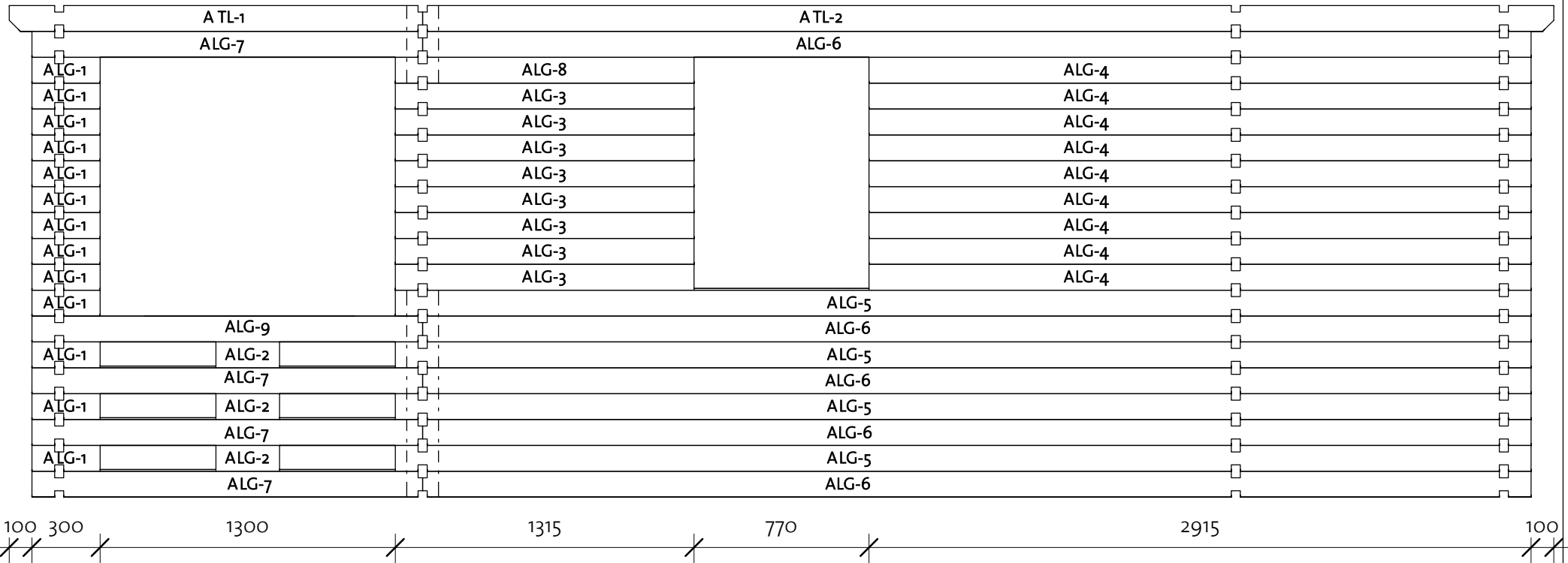



# Johnny 40 (380x480)

Wall B

Wall AB			
Mark	Profile	Count	Cut Length

ABLG-1	40x114	6	240
ABTL-1	40x57	1	240

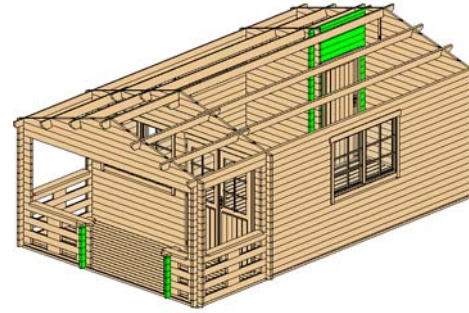
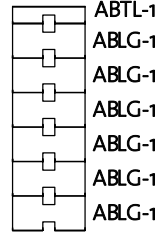

Wall B			
Mark	Profile	Count	Cut Length

BLG-1	40x114	34	285
BLG-2	40x114	4	1420
BLG-3	40x114	1	1420
BTL-1	40x66	1	1420

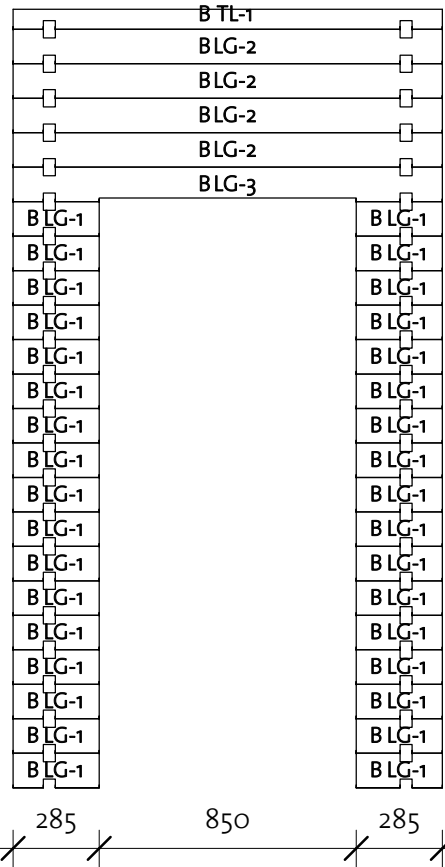

Log Profile Wall B	
Profile	Profile

40x114	
40x66	
40x57	

Wall BC			
Mark	Profile	Count	Cut Length

BCLG-1	40x114	6	240
BCTL-1	40x57	1	240

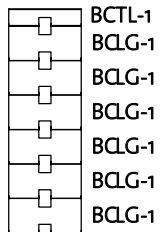

# Johnny 40 (380x480)

Wall C

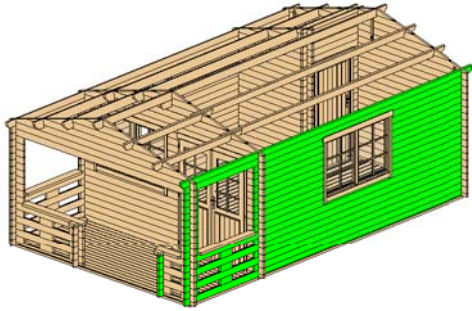

Log Profile Wall C

Profile	Profile
---------	---------

40X114



Log Profile Wall C

Profile	Profile
---------	---------

40X114



Wall C			
Mark	Profile	Count	Cut Length

CLG-1	40X114	3	280
CLG-2	40X114	13	300
CLG-3	40X114	9	1830
CLG-4	40X114	8	1630
CLG-5	40X114	4	5000
CLG-6	40X114	5	4880

Wall C			
Mark	Profile	Count	Cut Length

CLG-7	40X114	4	1720
CLG-8	40X114	1	1720
CLG-9	40X114	1	1630
CTL-1	40X114	1	1820
CTL-2	40X114	1	4980

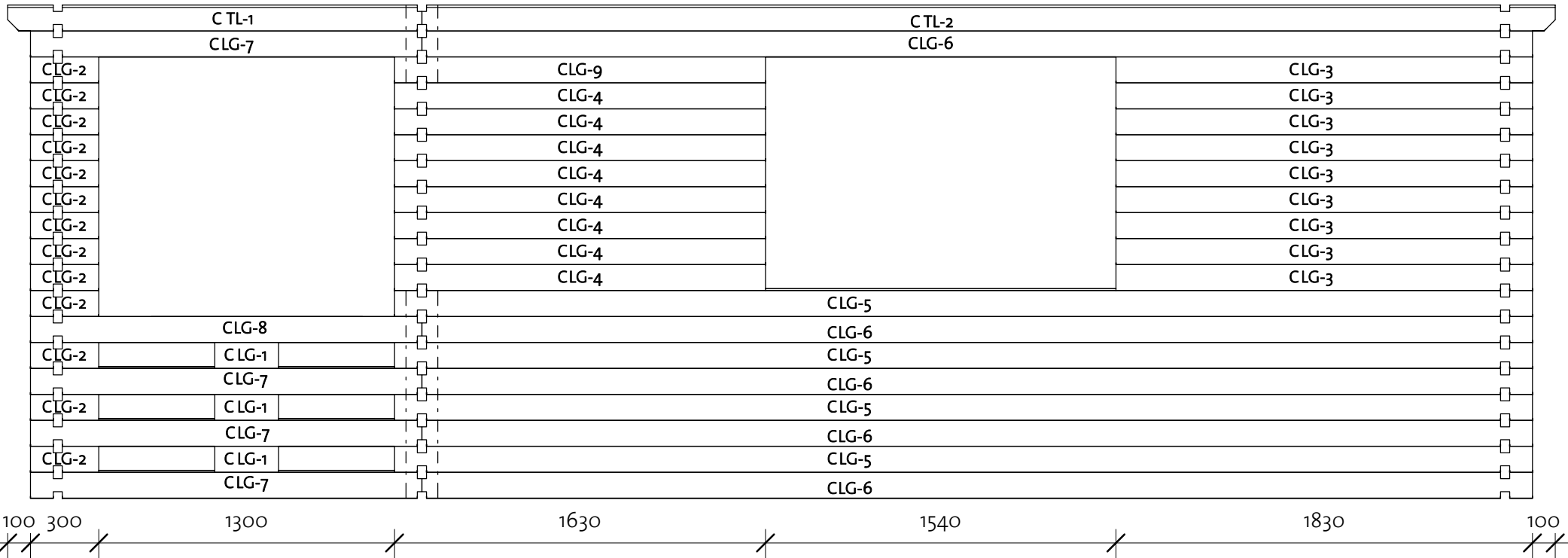

# Johnny 40 (380x480)

Roof 1

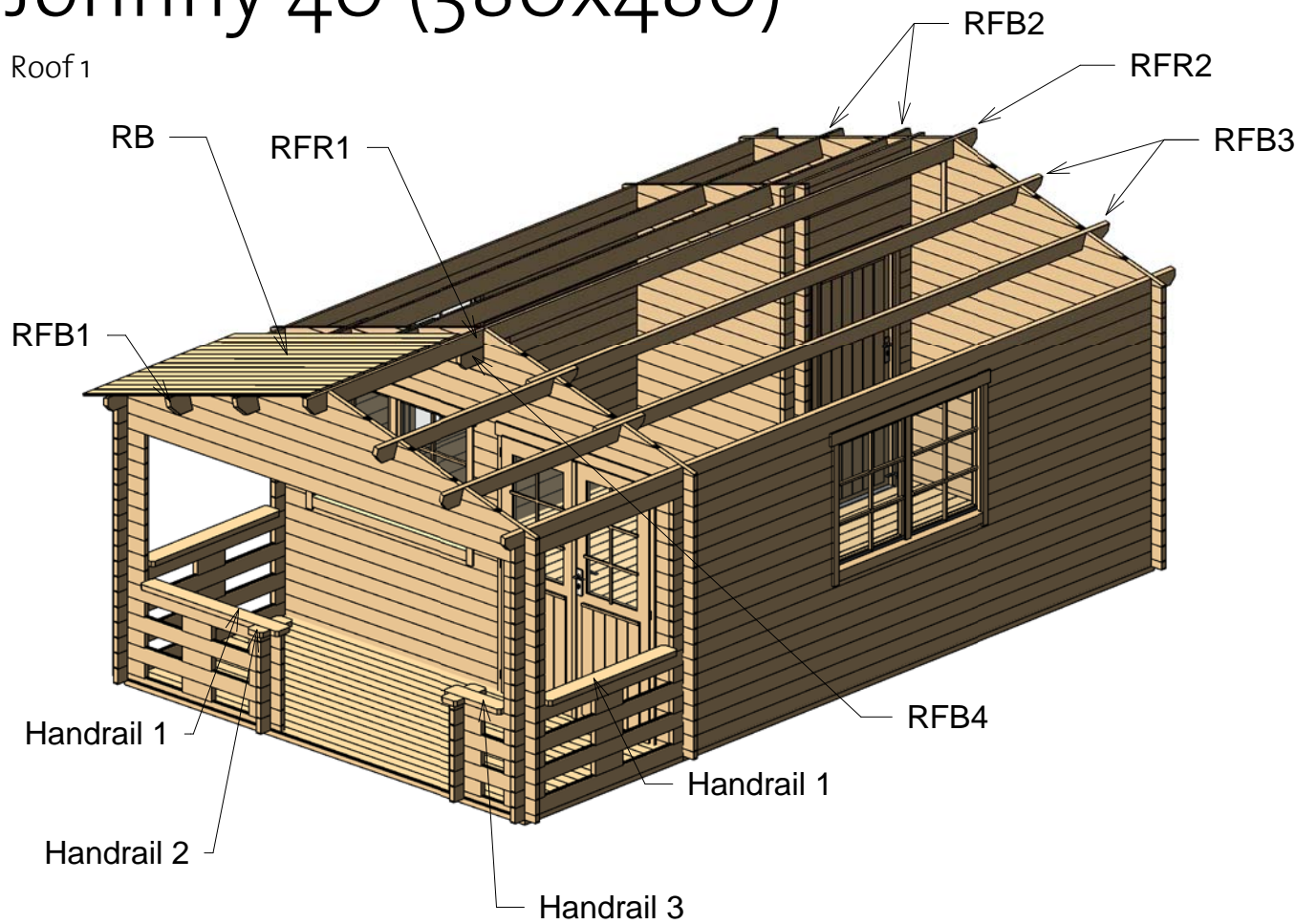

Type	Profile	Count	Length
------	---------	-------	--------

Handrail 1	40x143	3	1300
Handrail 2	40x143	4	94
Handrail 3	40x143	1	530



Roof				
Mark	Type	Profile	Count	Length

RB	18x110		126	2215
RFB1	Beam 40x143		4	2040
RFB2	Beam 40x143		2	5200
RFB3	Beam 40x143		2	5200
RFB4	Beam 40x120		1	500
RFR1	Ridge 40x143		1	1820
RFR2	Ridge 40x143		1	4980

# Johnny 40 (380x480)

Roof 2

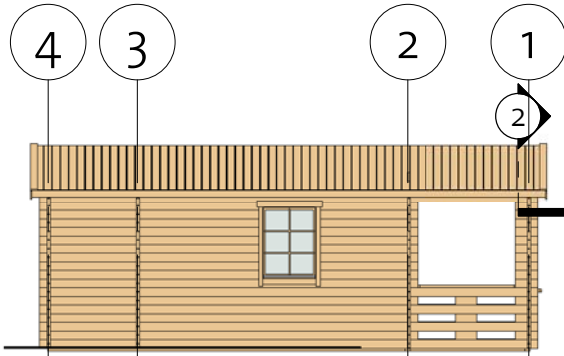

② Facia

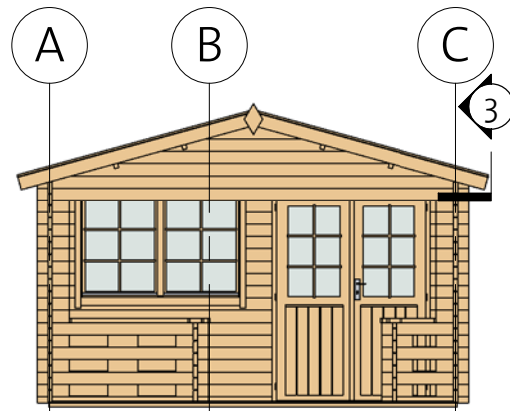
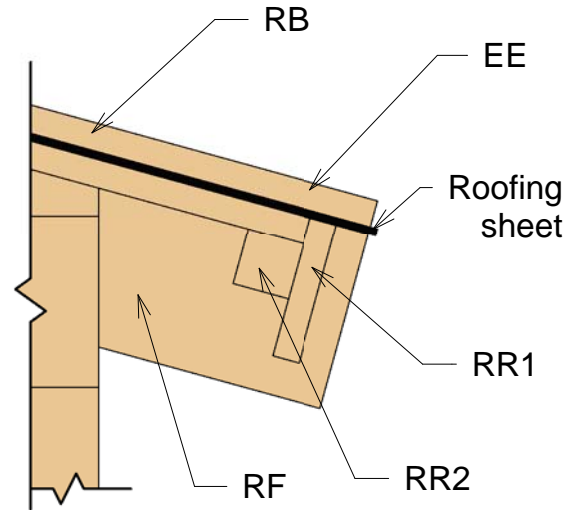

③ Roof Reinforcement

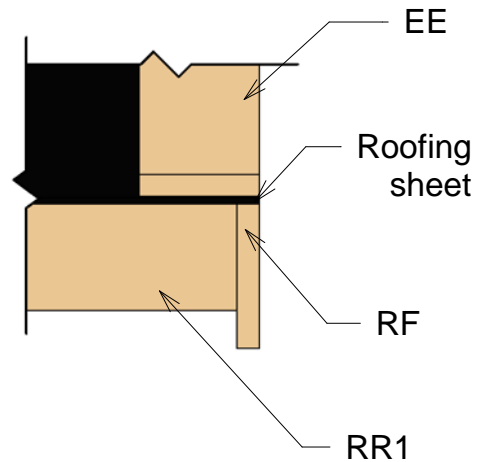

Fascia Schedule

Mark	Type	Profile	Count	Length
EE	Eave Edging 18x95		4	2260
RF	Roof Fascia 18x120		4	2260
RR1	Roof reinforcement 18x95		4	3400
RR2	Roof reinforcement 38x38		4	3400

# Johnny 40 (380x480)

Extras

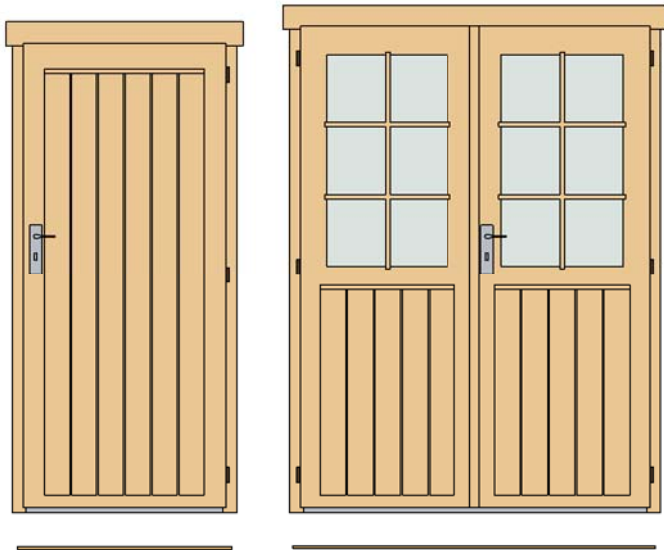

Fasteners/Extras		
Name	Type	Count

Hitblock	300-400 mm	
Bolts	M8x70	20
Screws	5,0 x 70	25
Dowel	16,0 x 150	26
Nails	1,4 x 40	110
Screws	4,0 x 40	135
Screws	6,0 x 140	170
Screws	4,0 x 50	1200

Door Schedule				
Model	Type	Width	Height	Count

CD5R	Classic door 5, wood right	840	1890	1
CDD1R	Classic double door 1 right	1425	1955	1

DCB6	Door Crossbar 6	--	--	2
------	-----------------	----	----	---

DB	Door beam 1440 mm	40	12	1
----	-------------------	----	----	---

DB	Door beam 850 mm	40	12	1
----	------------------	----	----	---

Window Schedule				
Mark	Type	Width	Height	Count

CDW1	Classic double window 1	1530	990	2
CW1L	Classic window 1 left	765	990	1
CW12R	Classic window 12, full glass right	540	540	1

WCB6	Windows Crossbar 6	--	--	5
------	--------------------	----	----	---

Type	Count	Length
------	-------	--------

Windboard 18x40	7	2200
-----------------	---	------

Type	Count
------	-------

Romb	2
------	---

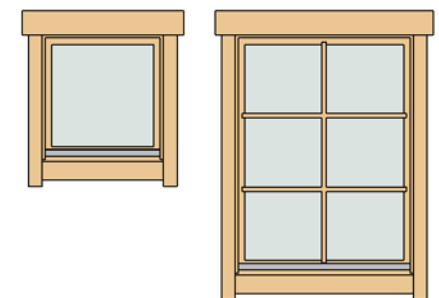
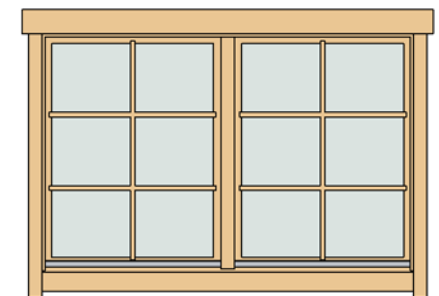

# Johnny 40 (380x480)

## List of all items 1

### Impregnated foundation beams

Mark	Type	Profile	Count	Length
IFB1	IFB 70x40		9	3650
IFB2	IFB 70x40		7	1530
IFB3	IFB 70x40		2	4720
IFB4	IFB 70x40		2	493
IFB5	IFB 70x40		2	3790

### Floor Schedule





Mark	Type	Profile	Count	Length
FB1	FB 18x110		14	1134
FB2	FB 18x110		15	3534
FB3	FB 18x110		22	4714

BB1	BB 18x40		2	3800
BB2	BB 18x40		2	3040
BB3	BB 18x40		2	4800

### Terrace Schedule





Mark	Type	Profile	Count	Length
TB	TB 18x95		18	3714

### Roof

Mark	Type	Profile	Count	Length
RB	18x110		126	2215
RFB1	Beam 40x143		4	2040
RFB2	Beam 40x143		2	5200
RFB3	Beam 40x143		2	5200
RFB4	Beam 40x120		1	500
RFR1	Ridge 40x143		1	1820
RFR2	Ridge 40x143		1	4980

# Johnny 40 (380x480)

## List of all items 2

Fascia Schedule				
Mark	Type	Profile	Count	Length
EE	Eave Edging 18x95		4	2260
RF	Roof Fascia 18x120		4	2260
RR1	Roof reinforcement 18x95		4	3400
RR2	Roof reinforcement 38x38		4	3400

# Johnny 40 (380x480)

## List of all items 3

Wall 1			
Mark	Profile	Count	Cut Length

1BL-1	40X57	1	815
1BL-2	40X57	1	1585
1LG-1	40X114	32	300
1LG-2	40X114	2	815
1LG-3 *	40X114	1	828
1LG-4	40X114	2	1585
1LG-5 *	40X114	1	1654
1LG-6 *	40X114	1	2481
1LG-7 *	40X114	1	3307
1LG-8	40X114	2	4000
1LG-9 *	40X114	1	4000
1LG-10	40X114	3	280
1LG-11	40X114	1	1585
1LG-12	40X114	1	815

Wall 3			
Mark	Profile	Count	Cut Length

3BL-1	40X57	1	1720
3LG-1	40X114	1	547
3LG-2	40X114	1	960
3LG-3	40X114	1	1373
3LG-4	40X114	18	1720
3LG-5	40X114	1	1720
3LG-6	40X114	1	100

Wall 2			
Mark	Profile	Count	Cut Length

2BL-1	40X57	1	370
2BL-2	40X57	1	2190
2LG-1	40X114	9	280
2LG-2	40X114	26	370
2LG-3 *	40X114	1	828
2LG-4 *	40X114	1	1654
2LG-5	40X114	8	2190
2LG-6 *	40X114	1	2481
2LG-7 *	40X114	1	3307
2LG-8	40X114	1	4000
2LG-9 *	40X114	1	4000

\* Gable - delivered premounted

Wall 4			
Mark	Profile	Count	Cut Length

4BL-1	40X57	1	4000
4LG-1	40X114	5	588
4LG-2	40X114	1	794
4LG-3	40X114	1	1654
4LG-4	40X114	1	2481
4LG-5	40X114	5	2868
4LG-6	40X114	1	3307
4LG-7	40X114	13	4000
4LG-8	40X114	1	4000



# Johnny 40 (380x480)

## List of all items 4

### Wall A

Mark	Profile	Count	Cut Length
------	---------	-------	------------

ALG-1	40X114	13	300
ALG-2	40X114	3	280
ALG-3	40X114	8	1315
ALG-4	40X114	9	2915
ALG-5	40X114	4	5000
ALG-6	40X114	5	4880







### Wall A

Mark	Profile	Count	Cut Length
------	---------	-------	------------

ALG-7	40X114	4	1720
ALG-8	40X114	1	1315
ALG-9	40X114	1	1720
ATL-1	40X114	1	1820
ATL-2	40X114	1	4980

### Log profiles

Profile	Profile
---------	---------

40X57	
40X114	
40X57	
40X66	
40X114	
40X114	

### Wall B

Mark	Profile	Count	Cut Length
------	---------	-------	------------

BLG-1	40X114	34	285
BLG-2	40X114	4	1420
BLG-3	40X114	1	1420
BTL-1	40X66	1	1420

### Wall C

Mark	Profile	Count	Cut Length
------	---------	-------	------------

CLG-1	40X114	3	280
CLG-2	40X114	13	300
CLG-3	40X114	9	1830
CLG-4	40X114	8	1630
CLG-5	40X114	4	5000
CLG-6	40X114	5	4880

### Wall C

Mark	Profile	Count	Cut Length
------	---------	-------	------------

CLG-7	40X114	4	1720
CLG-8	40X114	1	1720
CLG-9	40X114	1	1630
CTL-1	40X114	1	1820
CTL-2	40X114	1	4980

### Wall BC

Mark	Profile	Count	Cut Length
------	---------	-------	------------

BCLG-1	40X114	6	240
BCTL-1	40X57	1	240

### Wall AB

Mark	Profile	Count	Cut Length
------	---------	-------	------------

ABLG-1	40X114	6	240
ABTL-1	40X57	1	240