

Diana 40 (360x550)

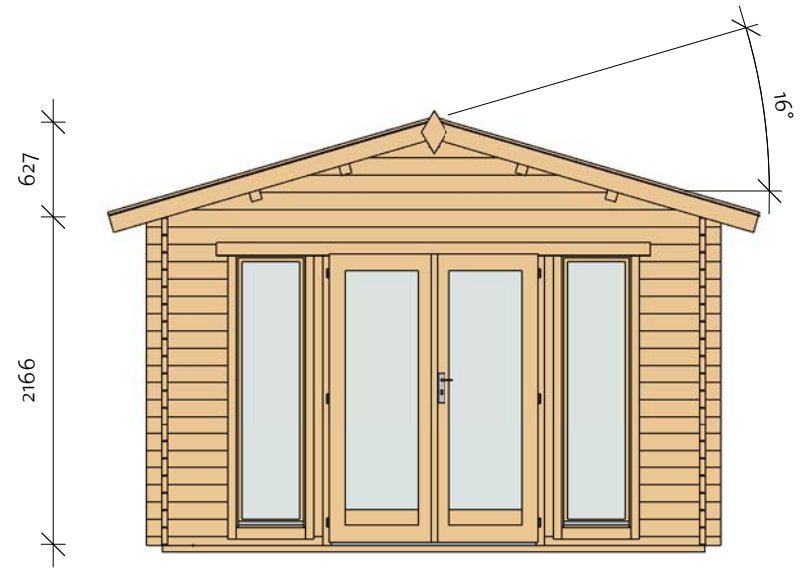

Diana 40 (360x550)

Foundation

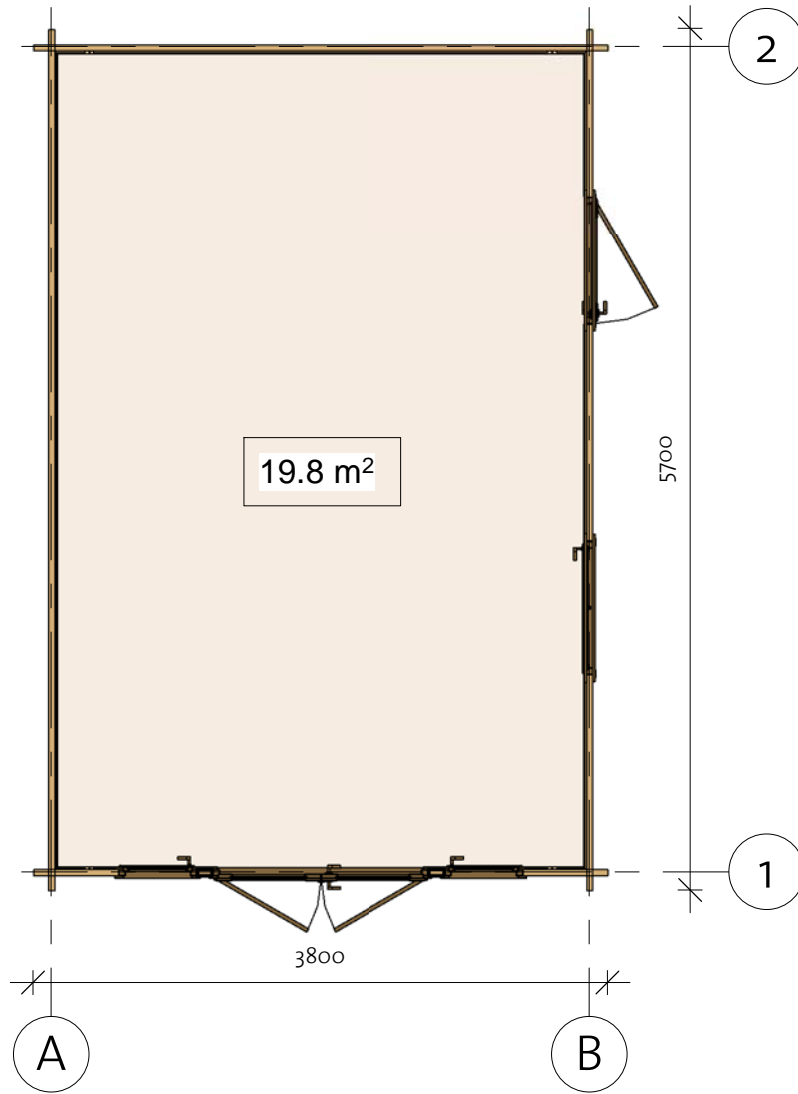
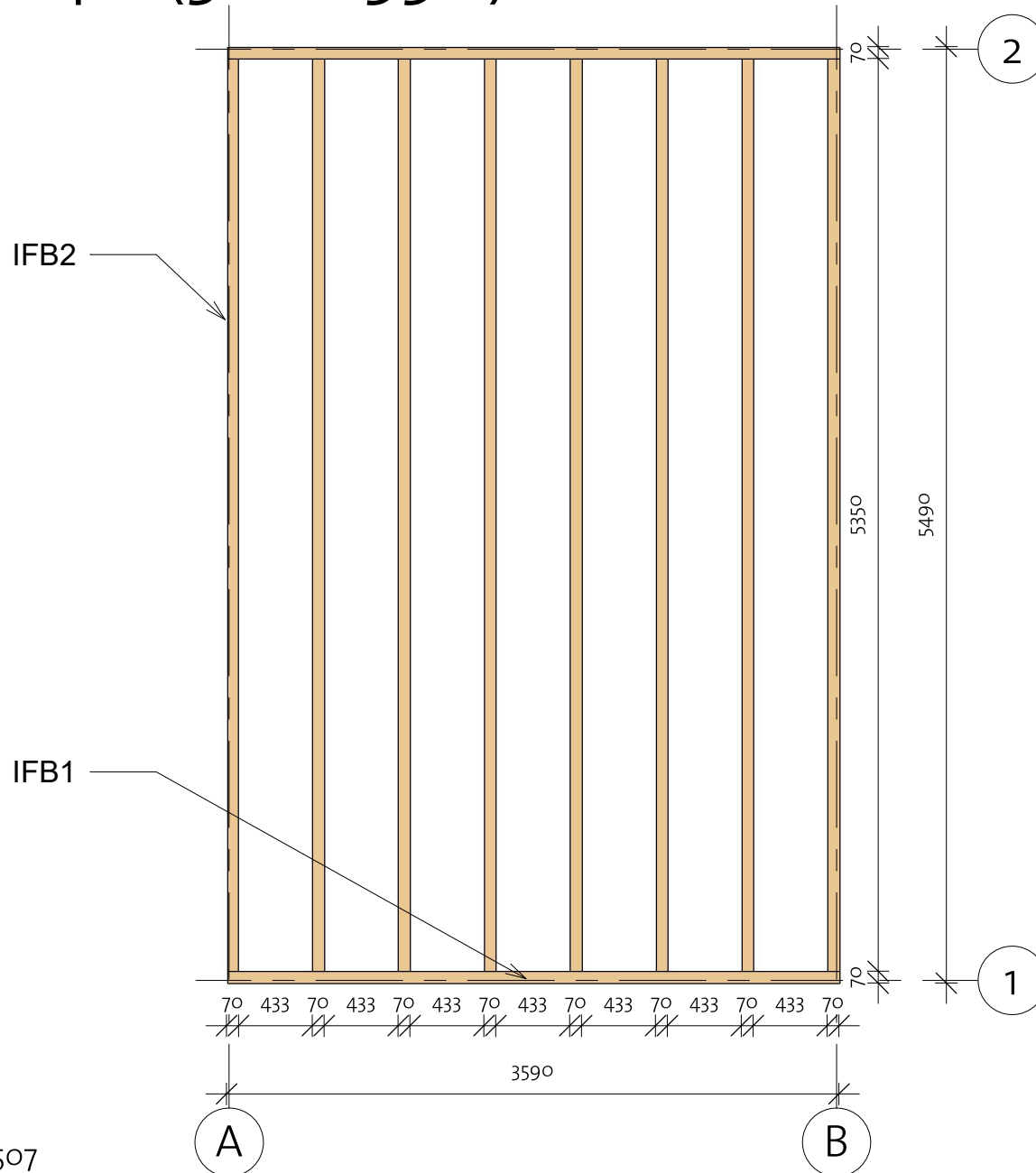

Impregnated foundation beams				
Mark	Type	Profile	Count	Length
IFB1	IFB 70x40		8	5350
IFB2	IFB 70x40		2	3590



Diana 40 (360x550)

Floor Plan

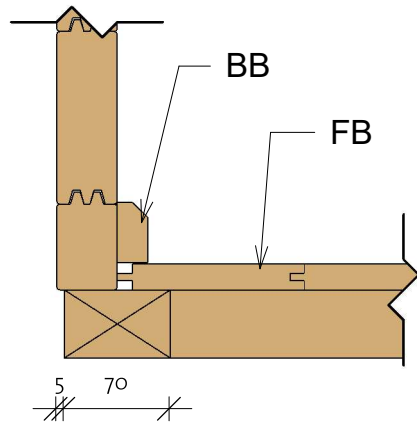
① Baseboard



Floor Schedule

Mark	Type	Profile	Count	Length
FB	FB 17x114		49	3517
BB1	BB 20x40		2	3600
BB2	BB 20x40		2	5500

91811052_200507

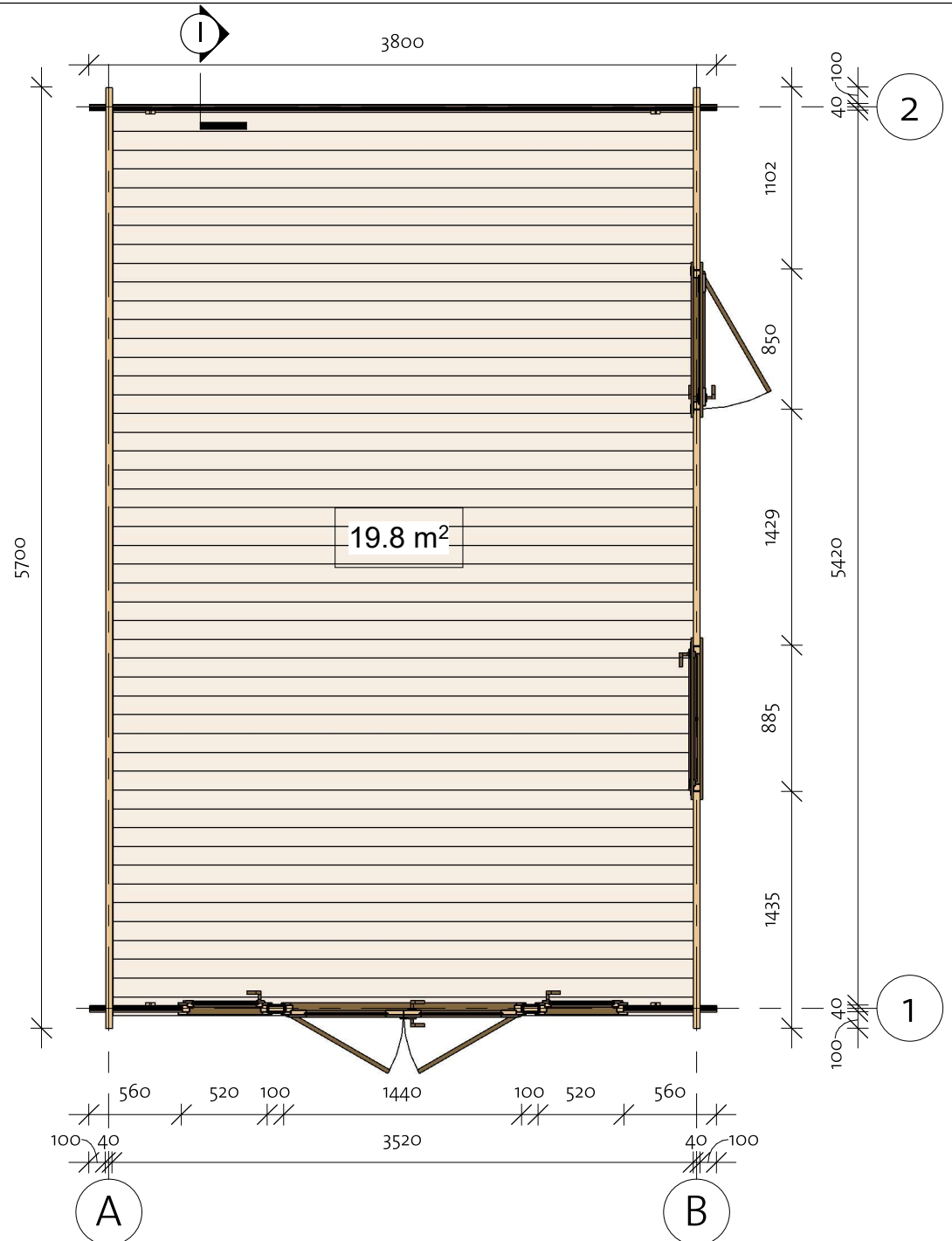

Diana 40 (360x550)

Wall 1

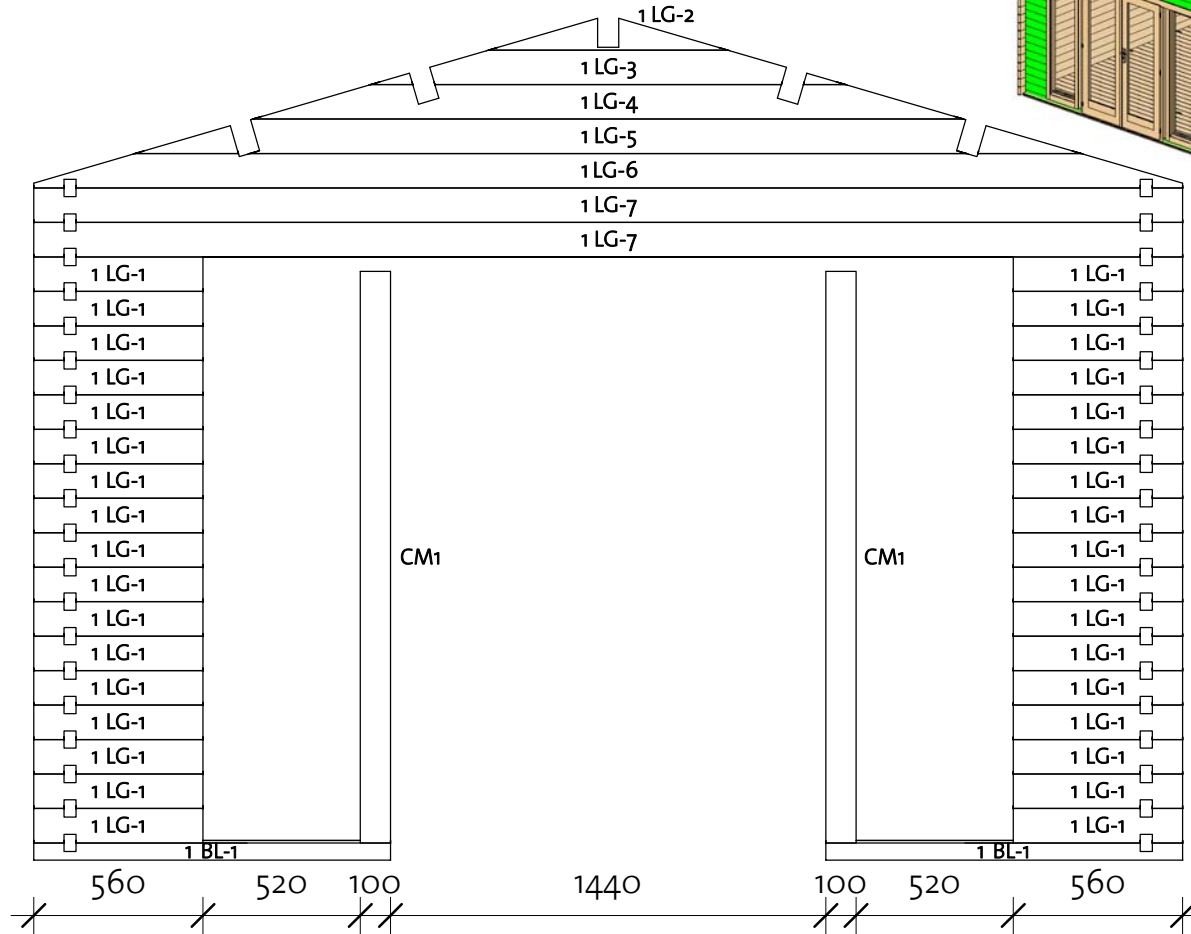
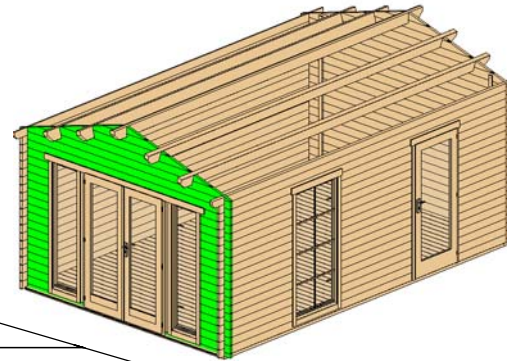



Wall 1			
Mark	Profile	Count	Cut Length

1BL-1	40x57	2	1180
1LG-1	40x114	34	560
1LG-2*	40x114	1	791
1LG-3*	40x114	1	1571
1LG-4*	40x114	1	2351
1LG-5*	40x114	1	3130
1LG-6*	40x114	1	3800
1LG-7	40x114	2	3800

* Gable - delivered premounted

Log Profile Wall 1	
Profile	Profile

40x57	
40x114	

Columns			
Mark	Profile	Count	Length
CM1	Post 100x40	2	1890

Diana 40 (360x550)

Wall 2

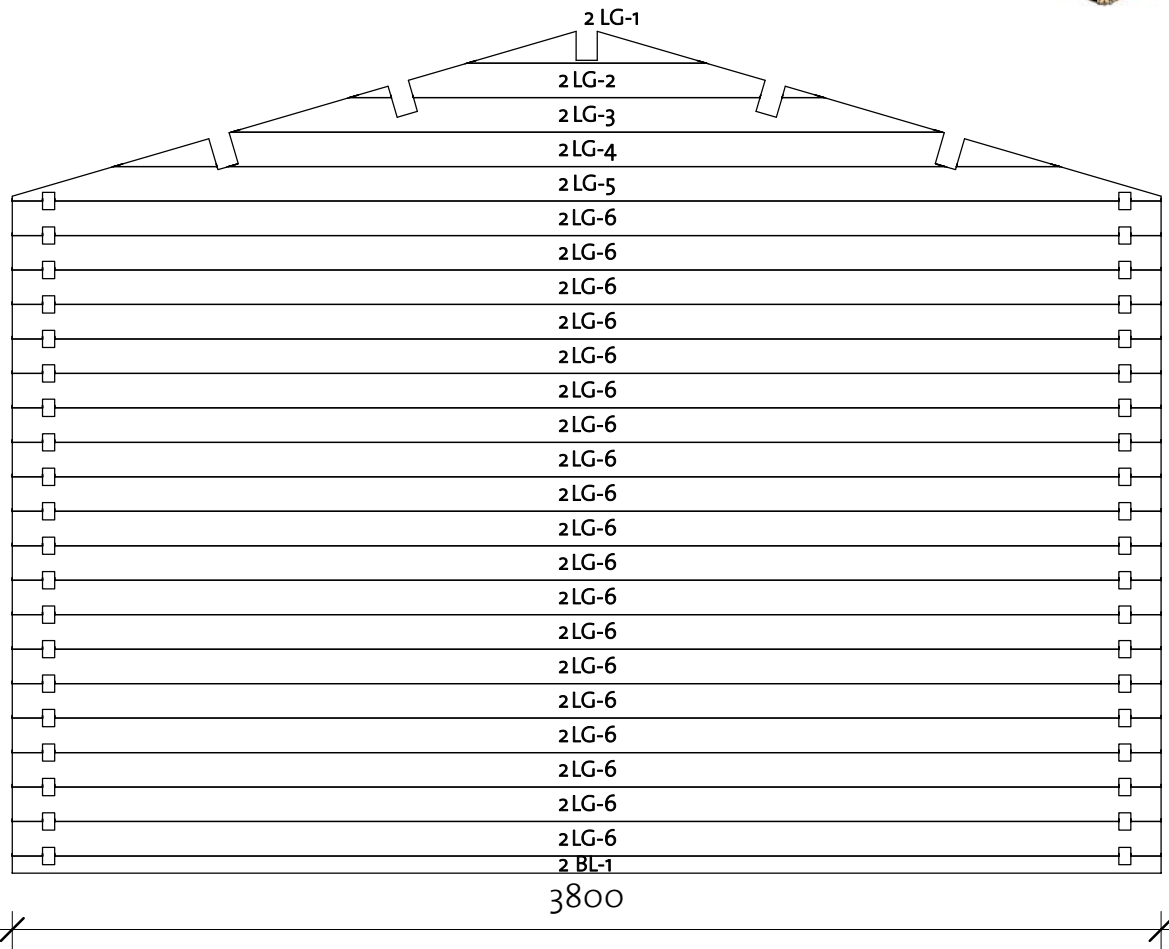
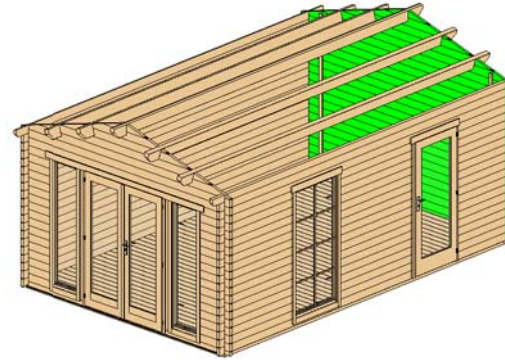

Wall 2			
Mark	Profile	Count	Cut Length

2BL-1	40x57	1	3800
2LG-1*	40x114	1	791
2LG-2*	40x114	1	1571
2LG-3*	40x114	1	2351
2LG-4*	40x114	1	3130
2LG-5*	40x114	1	3800
2LG-6	40x114	19	3800

* Gable - delivered premounted

Log Profile Wall 2	
Profile	Profile

40x57	
40x114	

Diana 40 (360x550)

Wall B

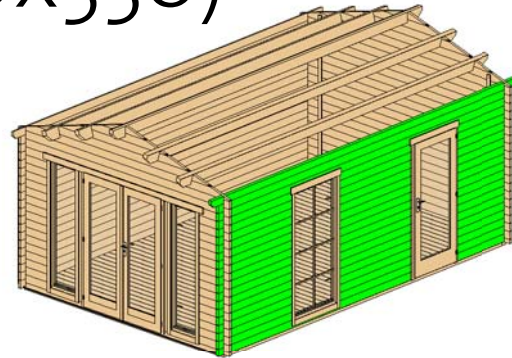

Log Profile Wall B	
Profile	Profile

40X114	
40X114	

Wall B			
Mark	Profile	Count	Cut Length

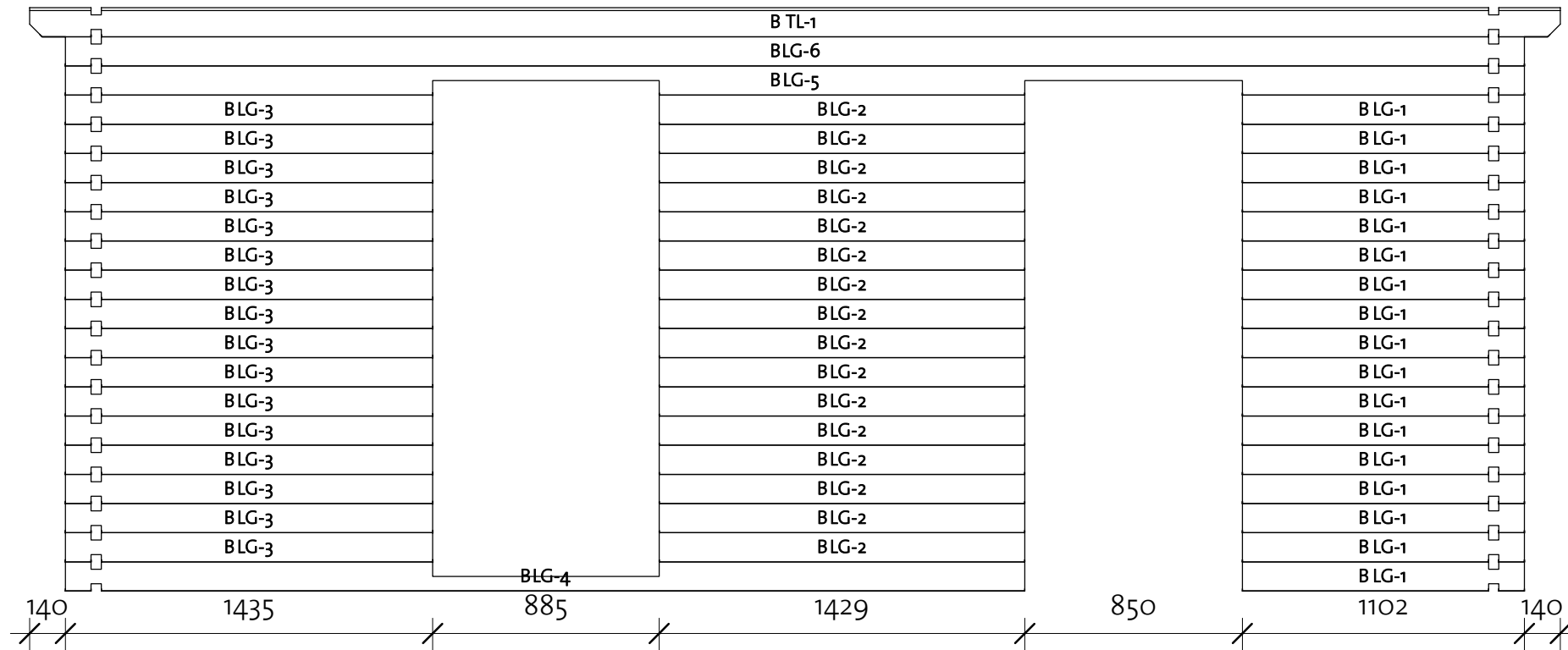

BLG-1	40X114	17	1102
BLG-2	40X114	16	1429
BLG-3	40X114	16	1435
BLG-4	40X114	1	3748
BLG-5	40X114	1	5700
BLG-6	40X114	1	5700
BTL-1	40X114	1	5980

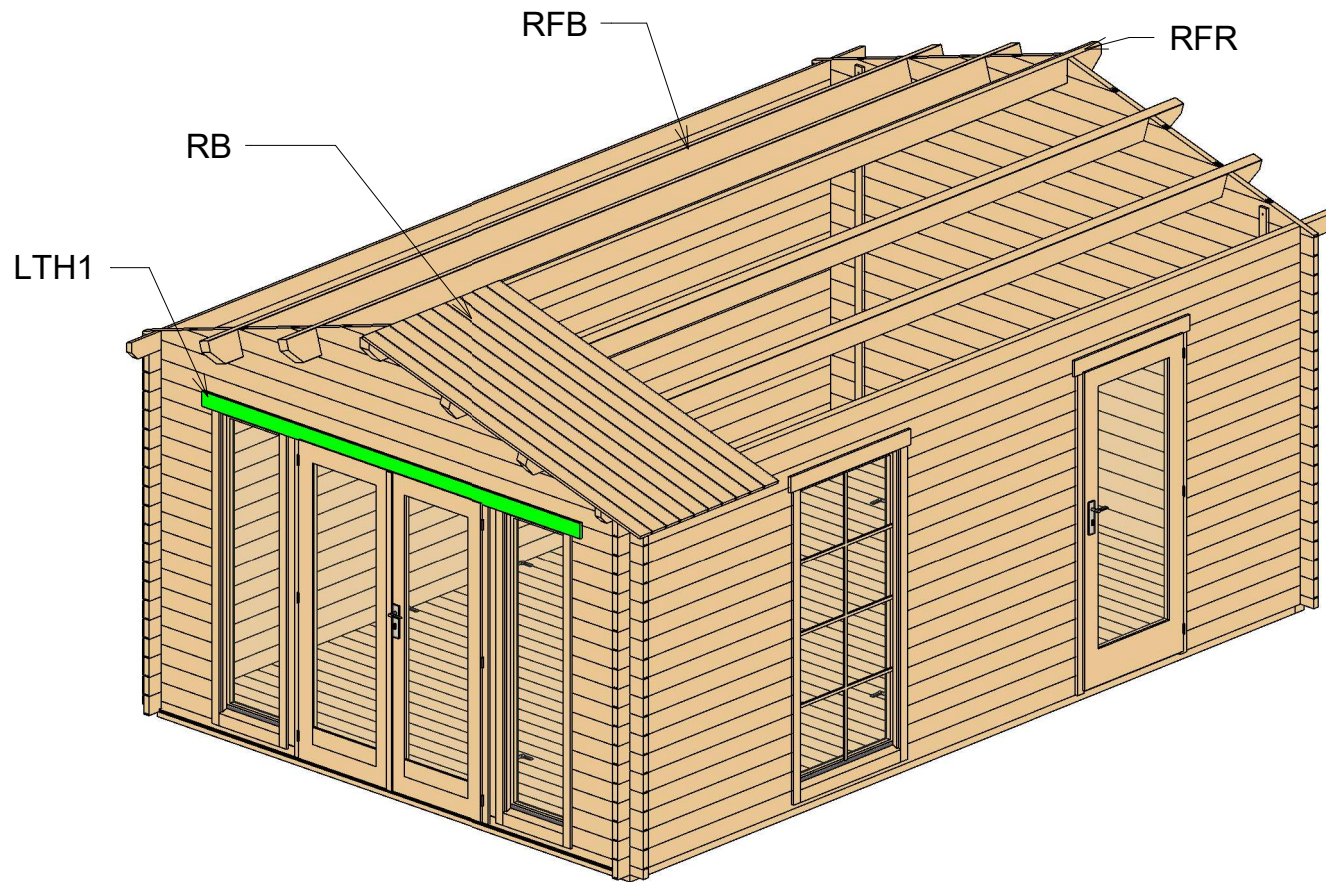

Diana 40 (360x550)

Roof 1



Roof				
Mark	Type	Profile	Count	Length
RFR	Ridge 68x160		1	5980
RFB	Beam 68x160		4	5980
RB	17x114		108	2200

Lath list				
Mark	Type	Profile	Count	Length
LTH1	18x95		2	2875

Diana 40 (360x550)

Roof 2

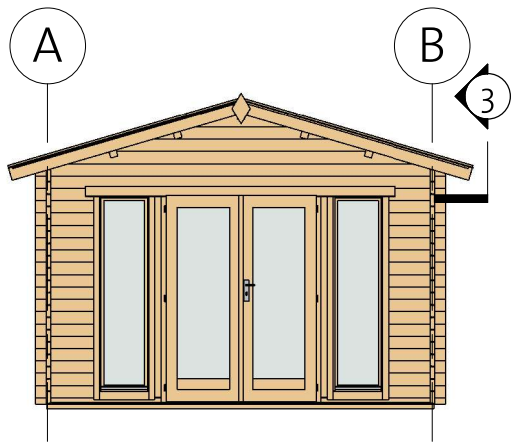
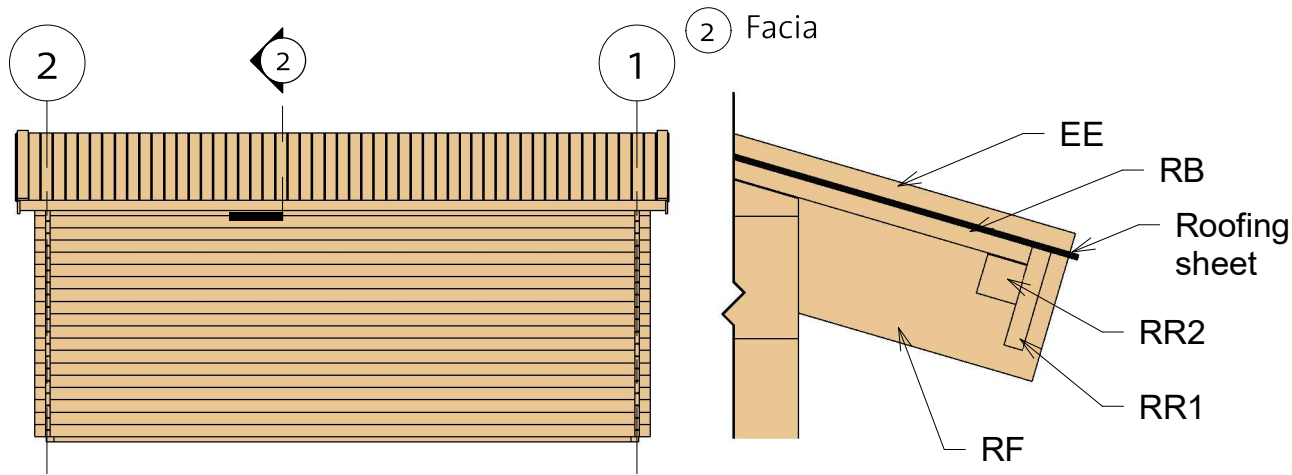

Fascia Schedule				
Mark	Type	Profile	Count	Length

EE	Eave Edging 18x95		4	2240
RF	Roof Fascia 18x120		4	2240
RR1	Roof reinforcement 18x95		2	5980
RR2	Roof reinforcement 38x38		2	5980

Diana 40 (360x550)

Extras

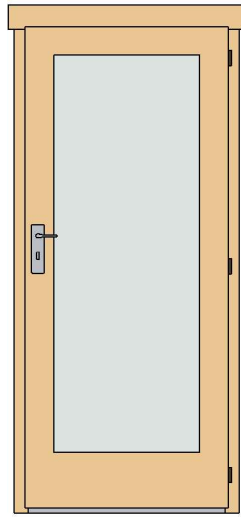
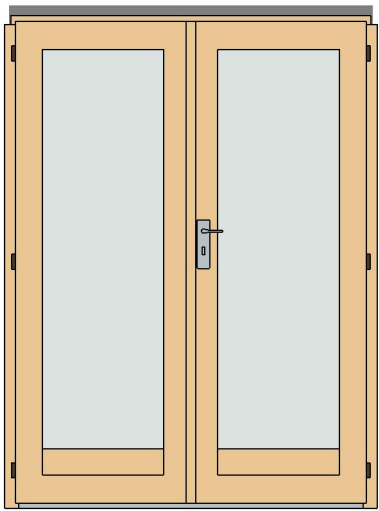

Door Schedule				
Mark	Type	Width	Height	Count
CD6R	Classic door 6, full glass right	840	1955	1
CDD3R	Classic double door 3, full glass right	1425	1955	1



Family	Count
Romb	2

Type	Count	Length
Windboard 18x40	4	2220

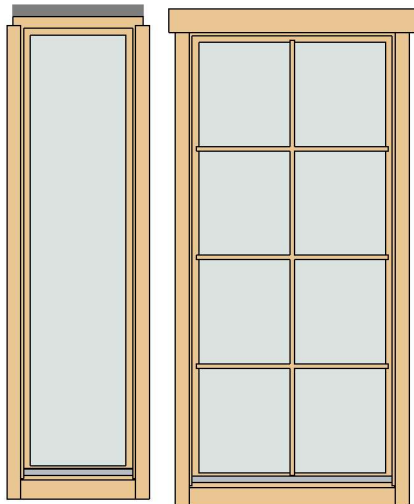

Window Schedule				
Mark	Type	Width	Height	Count
CW3L	Classic window 3, full glass left	515	1890	1
CW3R	Classic window 3, full glass right	515	1890	1
CW4R	Classic window 4, right	875	1890	1
WCB8	Windows Crossbar 8	--	--	1



Fasteners & Extras		
Name	Type	Count

Hitblock	300-400 mm	
Screws	5,0 x 70	10
Bolts	M8 x 70	12
Nails	1,4 x 40	45
Screws	6,0 x 140	60
Screws	4,0 x 40	130
Screws	4,0 x 50	900



Diana 40 (360x550)

List of all items 1



Impregnated foundation beams

Mark	Type	Profile	Count	Length
IFB1	IFB 70x40		8	5350
IFB2	IFB 70x40		2	3590





Floor Schedule

Mark	Type	Profile	Count	Length
FB	FB 17x114		49	3517
BB1	BB 20x40		2	3600
BB2	BB 20x40		2	5500

Roof

Mark	Type	Profile	Count	Length
RFR	Ridge 68x160		1	5980
RFB	Beam 68x160		4	5980
RB	17x114		108	2200

Fascia Schedule

Mark	Type	Profile	Count	Length
EE	Eave Edging 18x95		4	2240
RF	Roof Fascia 18x120		4	2240
RR1	Roof reinforcement 18x95		2	5980
RR2	Roof reinforcement 38x38		2	5980

Diana 40 (360x550)

List of all items 2

Wall 1			
Mark	Profile	Count	Cut Length

1BL-1	40x57	2	1180
1LG-1	40x114	34	560
1LG-2*	40x114	1	791
1LG-3*	40x114	1	1571
1LG-4*	40x114	1	2351
1LG-5*	40x114	1	3130
1LG-6*	40x114	1	3800
1LG-7	40x114	2	3800



Wall A			
Mark	Profile	Count	Cut Length

ALG-1	40x114	19	5700
ATL-1	40x114	1	5980

Lath list				
Mark	Type	Profile	Count	Length

LTH1	18x95		2	2875
------	-------	---	---	------

Log Profiles	
Profile	Profile

40x57	
40x114	

Wall 2			
Mark	Profile	Count	Cut Length

2BL-1	40x57	1	3800
2LG-1*	40x114	1	791
2LG-2*	40x114	1	1571
2LG-3*	40x114	1	2351
2LG-4*	40x114	1	3130
2LG-5*	40x114	1	3800
2LG-6	40x114	19	3800

* Gable - delivered premounted

Wall B			
Mark	Profile	Count	Cut Length

BLG-1	40x114	17	1102
BLG-2	40x114	16	1429
BLG-3	40x114	16	1435
BLG-4	40x114	1	3748
BLG-5	40x114	1	5700
BLG-6	40x114	1	5700
BTL-1	40x114	1	5980

Columns			
Mark	Profile	Count	Length

CM1	Post 100x40	2	1882
-----	-------------	---	------

Log Profiles	
Profile	Profile

40x114	
--------	---