

Montana 40 (380x575)

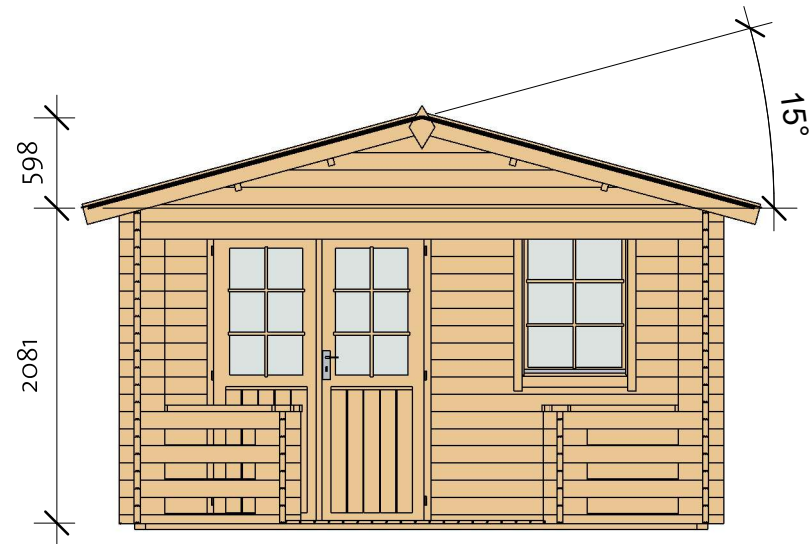

Montana 40 (380x575)

Foundation

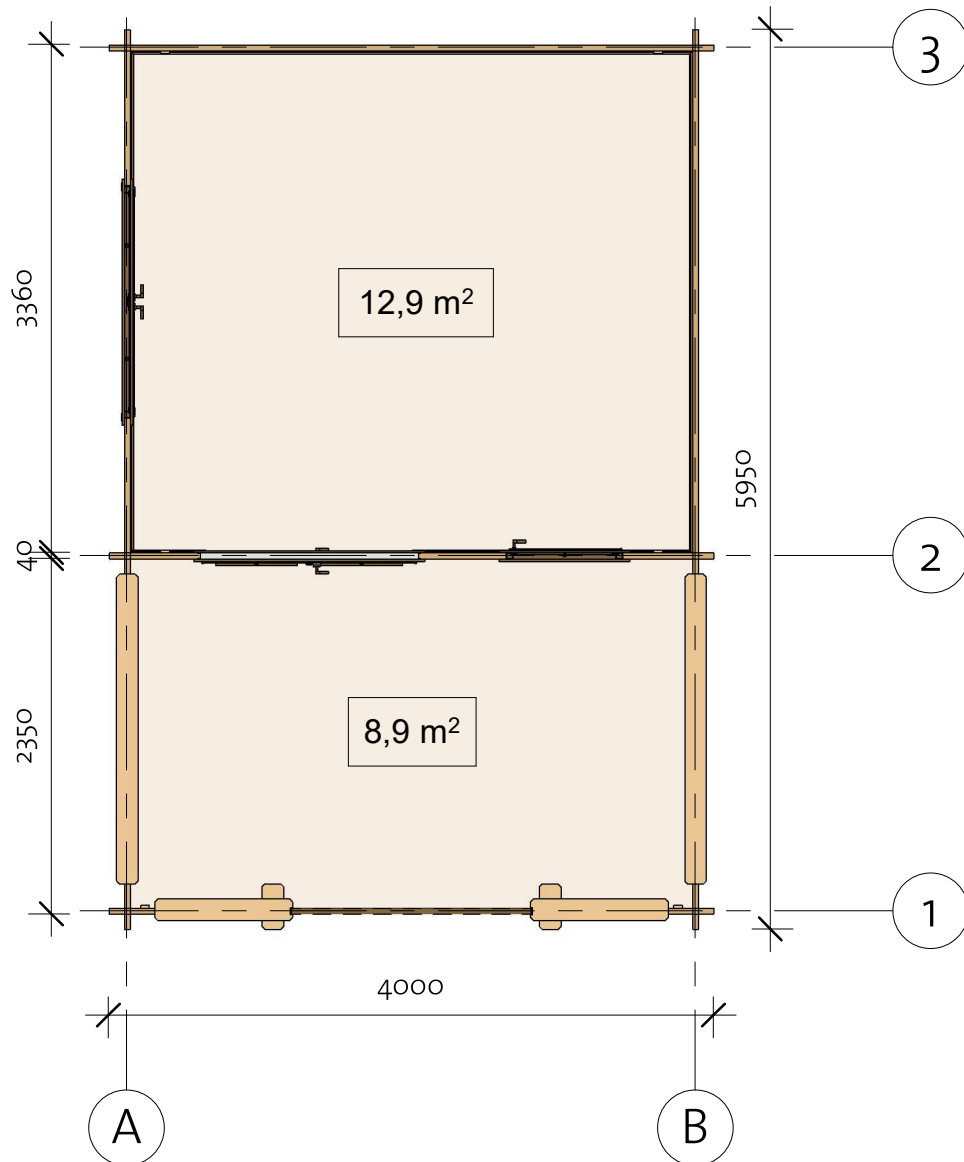
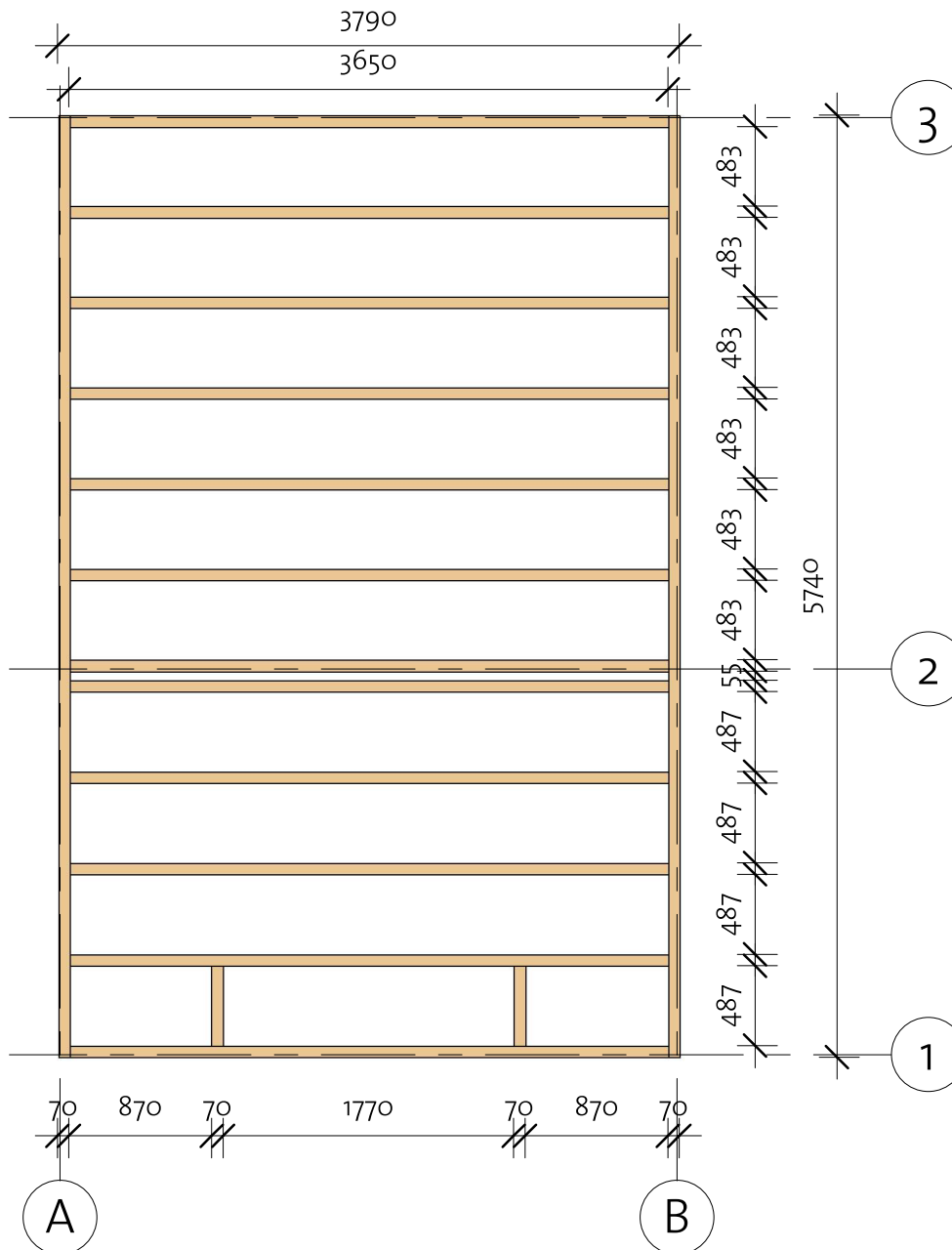

Impregnated foundation beams				
Mark	Type	Profile	Count	Length
IFB1	IFB 70x40		2	5740
IFB2	IFB 70x40		12	3650
IFB3	IFB 70x40		2	487

Montana 40 (380x575)

Floor Plan

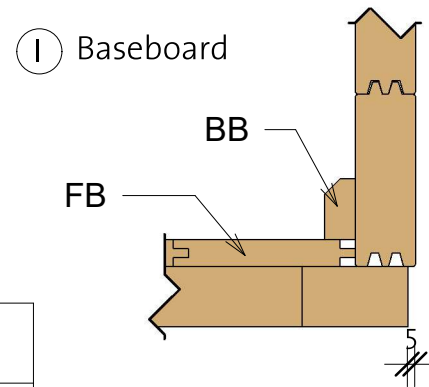

Floor Schedule				
Mark	Type	Profile	Count	Length

FB	FB 18x110		35	3316
TB1	TB 21x95		21	2310
TB2	TB 21x95		18	2350

BB1	BB 20x40		2	3800
BB2	BB 20x40		2	3400

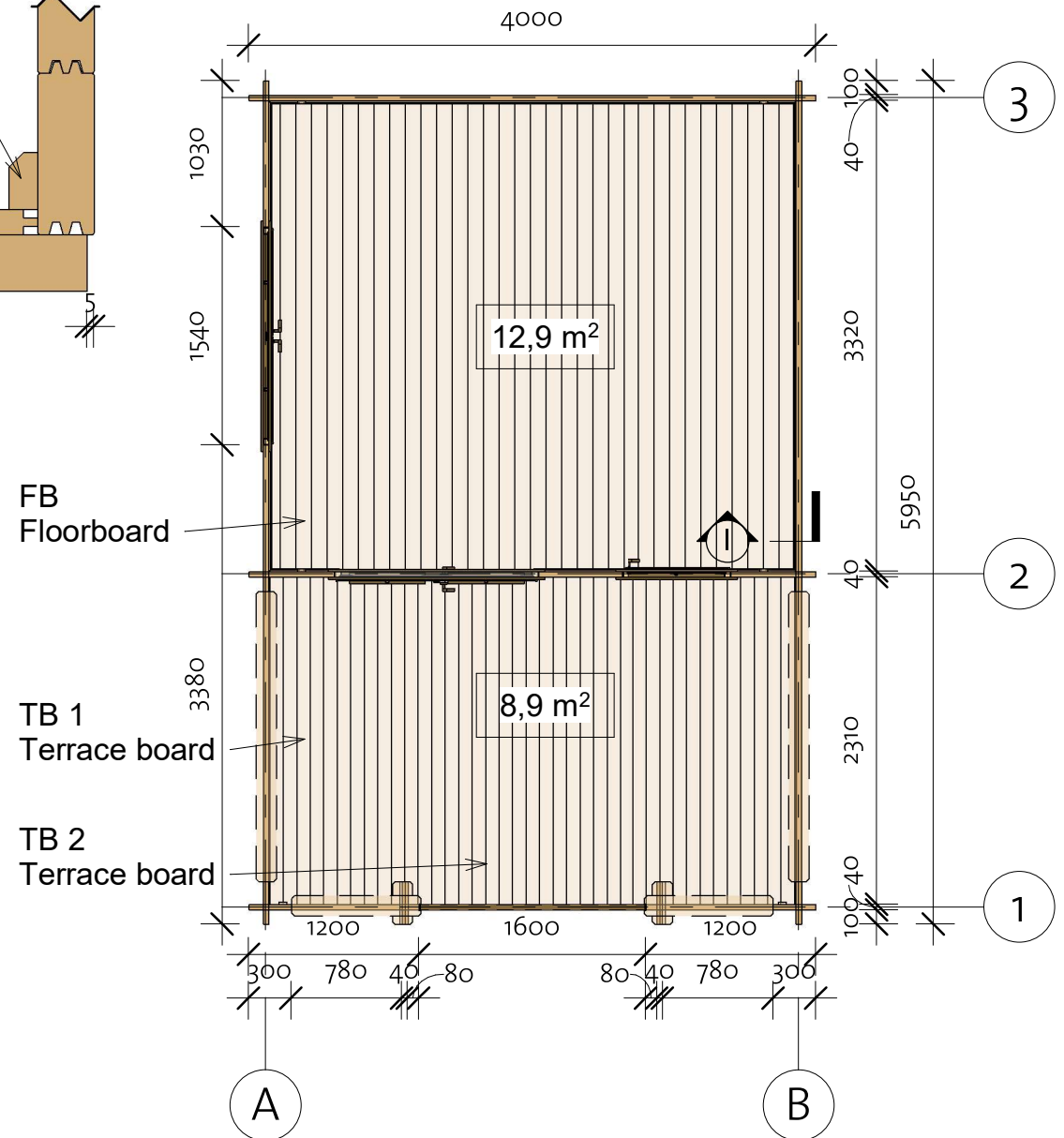

Montana 40 (380x575)

Wall 1

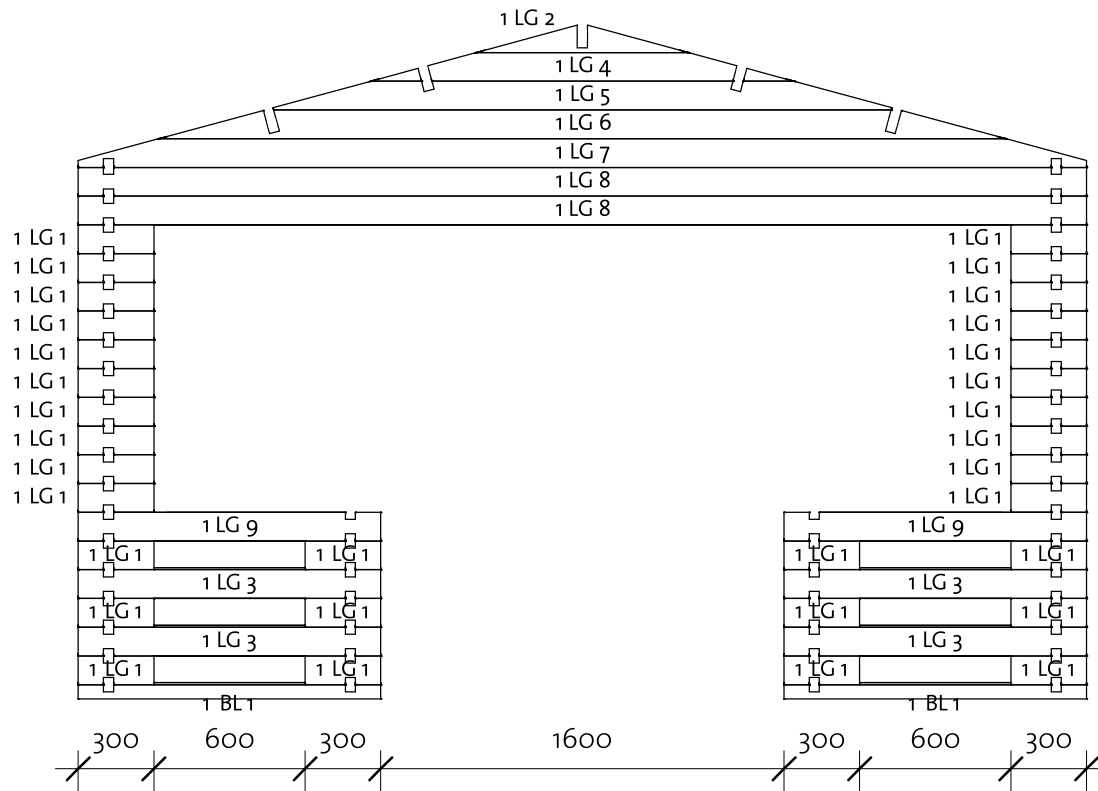
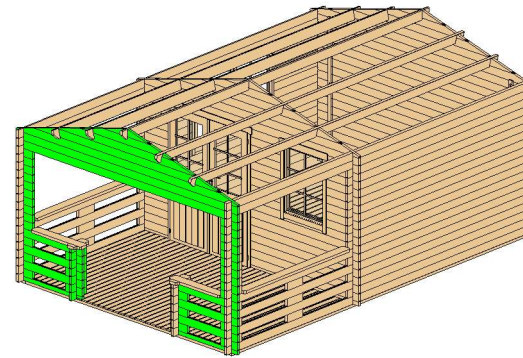

Wall 1			
Mark	Profile	Count	Cut Length

1BL 1	40X57	2	1200
1LG 1	40X114	32	300
1LG 2*	40X114	1	839
1LG 3	40X114	4	1200
1LG 4*	40X114	1	1679
1LG 5*	40X114	1	2454
1LG 6*	40X114	1	3358
1LG 7*	40X114	1	4000
1LG 8	40X114	2	4000
1LG 9	40X114	2	1200

* Gable - delivered premounted

Log Profile Wall 1	
Profile	Profile

40X57	
40X114	

Montana 40 (380x575)

Wall 3

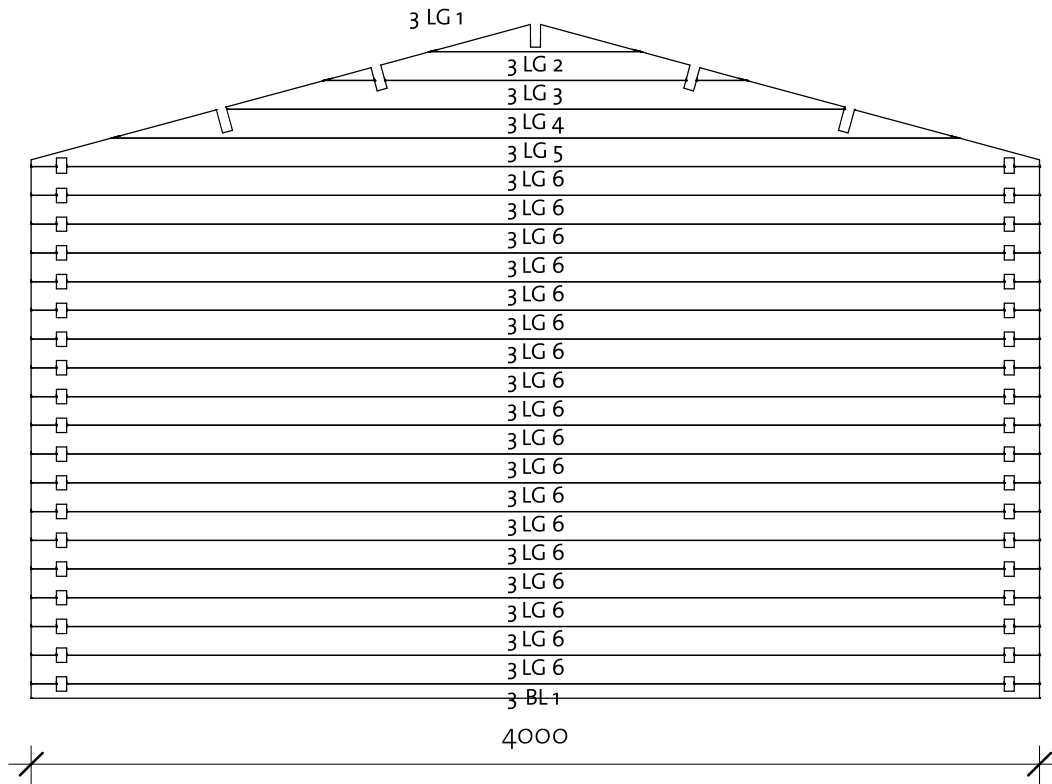
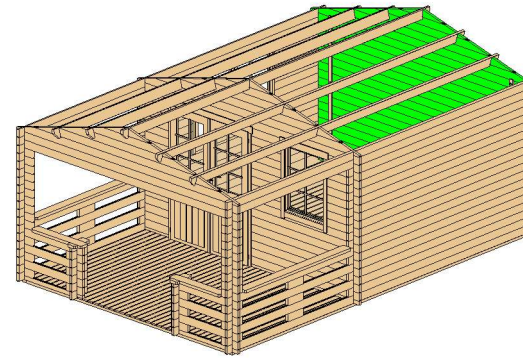

Wall 3			
Mark	Profile	Count	Cut Length

3BL 1	40x57	1	4000
3LG 1*	40x114	1	839
3LG 2*	40x114	1	1679
3LG 3*	40x114	1	2454
3LG 4*	40x114	1	3358
3LG 5*	40x114	1	4000
3LG 6	40x114	18	4000

* Gable - delivered premounted

Log Profile Wall 3	
Profile	Profile

40x57	
40x114	

Montana 40 (380x575)

Wall A

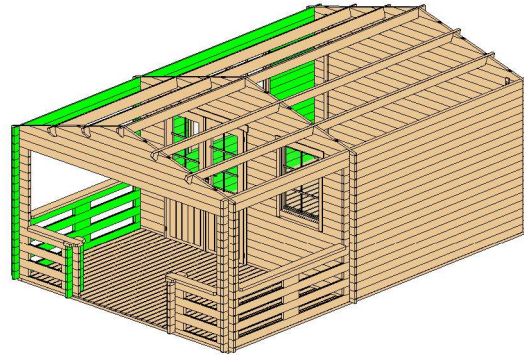

Wall AA			
Mark	Profile	Count	Cut Length
AALG 1	40x114	6	300
AATL 1	40x57	1	300

Wall A			
Mark	Profile	Count	Cut Length
ALG 1	40x114	13	300
ALG 2	40x114	3	300
ALG 3	40x114	18	1030
ALG 4	40x114	4	3600
ALG 5	40x114	4	5950
ALG 6	40x114	1	5950
ATL 1	40x122	1	5950

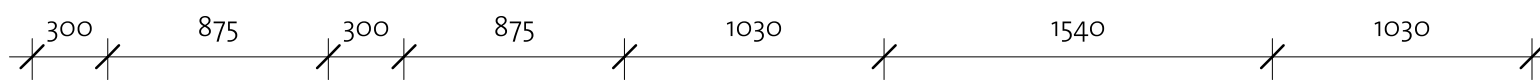
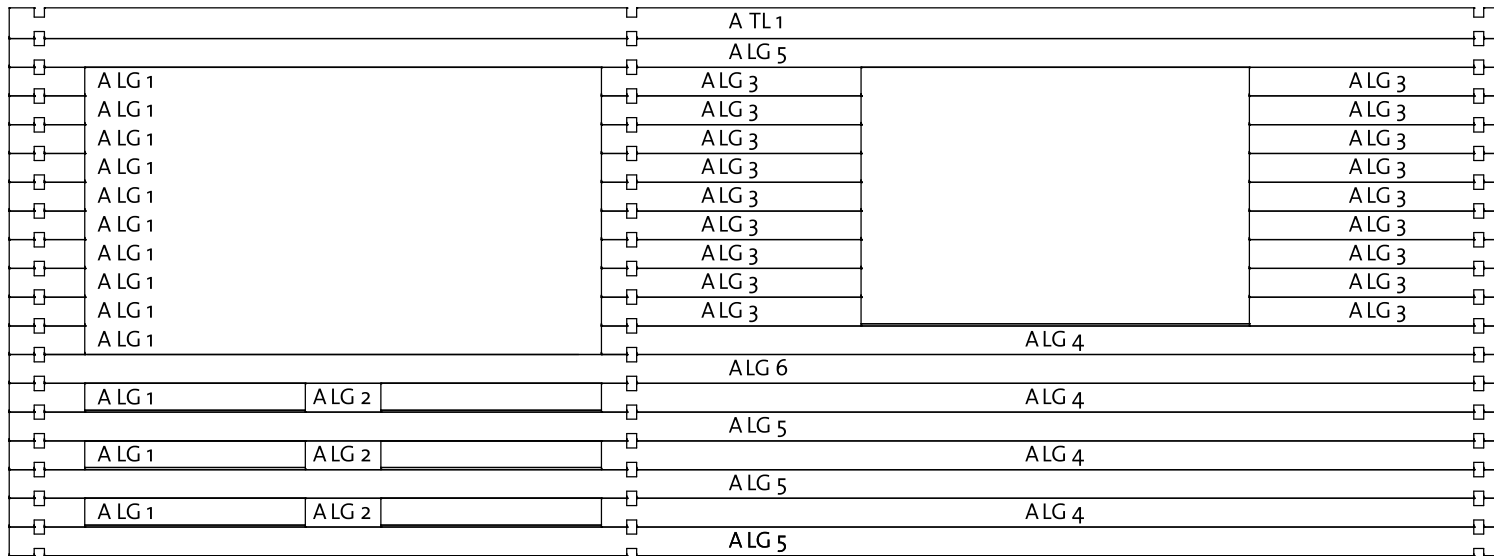
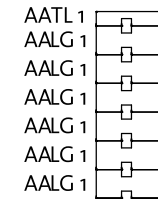

Log Profile Wall A	
Profile	Profile
40x57	
40x114	
40x122	

Montana 40 (380x575)

Wall B

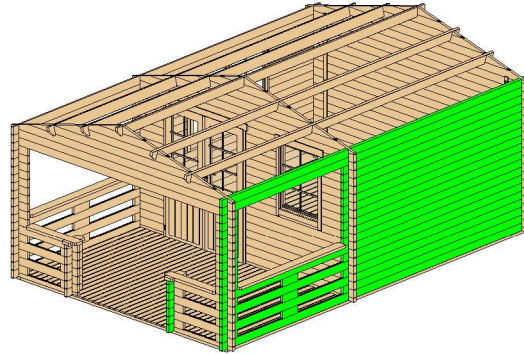

Wall AB			
Mark	Profile	Count	Cut Length

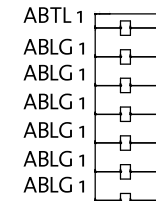

ABLG 1	40x114	6	300
ABTL 1	40x57	1	300



Wall B			
Mark	Profile	Count	Cut Length

BLG 1	40x114	13	300
BLG 2	40x114	3	300
BLG 3	40x114	13	3600
BLG 4	40x114	4	5950
BLG 5	40x114	1	5950
BTL 1	40x122	1	5950

Log Profile Wall B	
Profile	Profile

40x57	
40x114	
40x122	

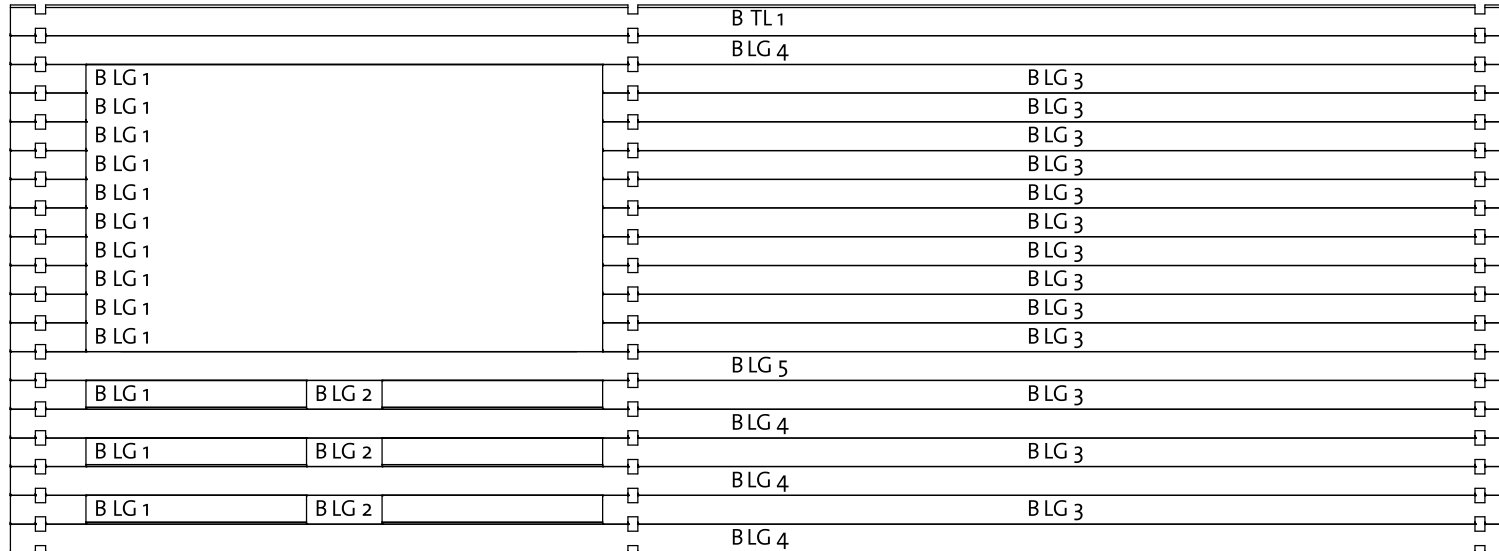

Montana 40 (380x575)

Roof 1

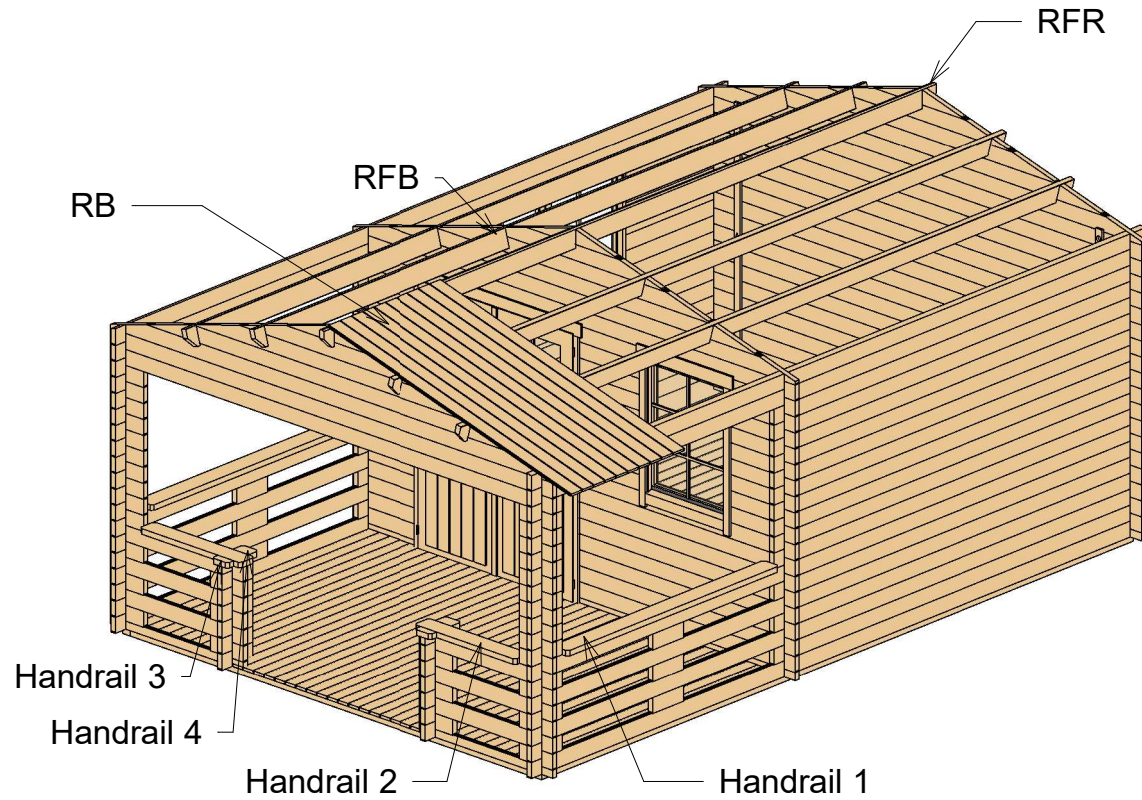

Roof				
Mark	Type	Profile	Count	Length
RFR	Ridge 40X143		1	5950
RFB	Beam 40X143		4	5950
RB	RoofBoard 18X110		110	2280

Type	Profile	Count	Length
------	---------	-------	--------

Handrail 1	40X143	2	2050
Handrail 2	40X143	2	910
Handrail 3	40X143	2	60
Handrail 4	40X143	2	100



Montana 40 (380x575)

Roof 2

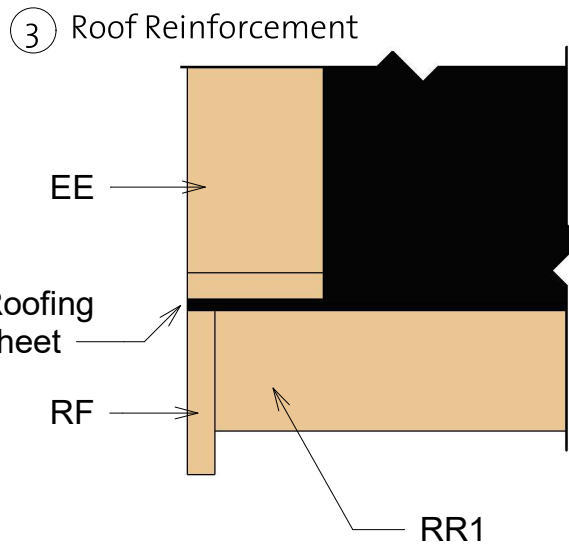
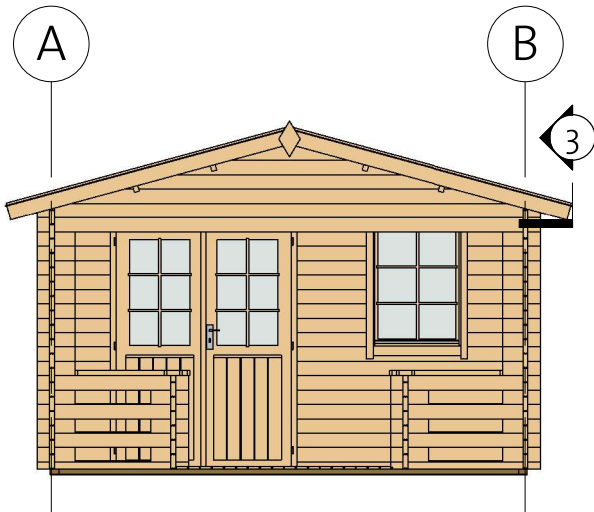
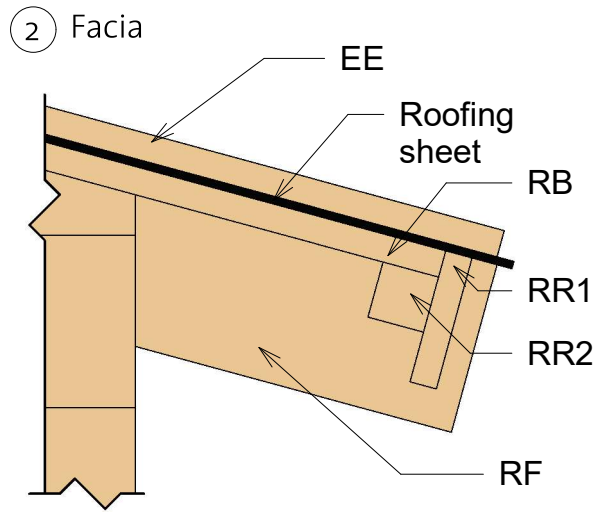
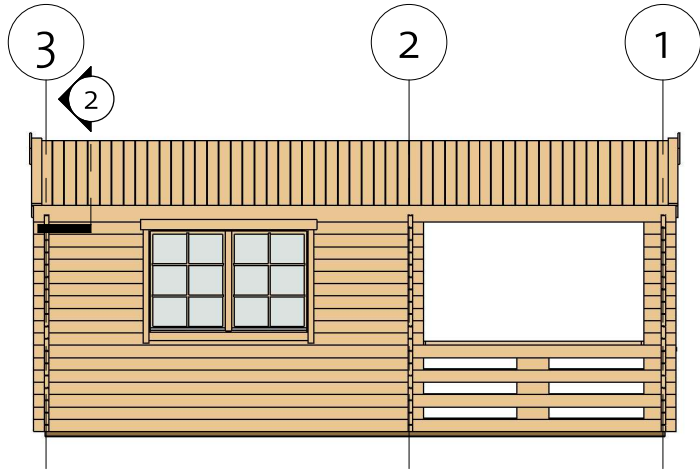

Fascia Schedule				
Mark	Type	Profile	Count	Length
EE	Eave Edging 18x90		4	2320
RF	Facia 18x115		4	2320
RR1	Roof reinforcement 18x90		4	2975
RR2	Roof reinforcement 38x38		4	2975

Montana 40 (380x575)

Extras

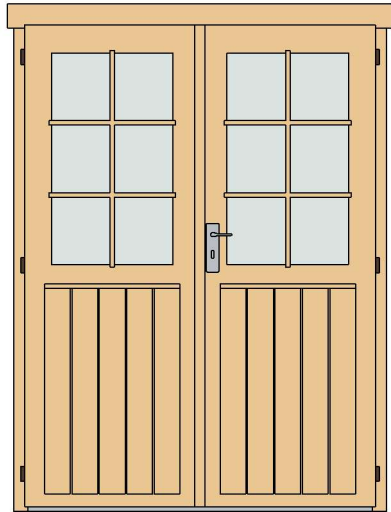

Door Schedule				
Model	Type	Width	Height	Count
CDD1	Classic double door 1	1425	1955	1
DCB6	Door crossbar 6	--	--	2
DB	Door beam 1440 mm	40	12	1

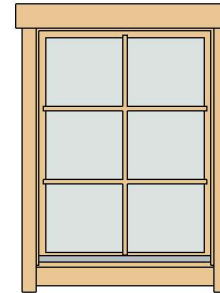

Window Schedule				
Model	Type	Width	Height	Count
CW1L	Classic window 1 left	765	990	1
CDW1	Classic double window 1	1530	990	1
WCB6	Window crossbar 6	--	--	3

Fasteners/Extras		
Name	Type	Count

Hitblock	300-400 mm	
Bolts	M8 x 70	18
Screws	5,0 x 70	35
Screws	6,0 x 140	75
Screws	4,0 x 40	130
Screws	4,0 x 50	1000



Type	Count	Lenght
Windboard 18x40	6	2200



Type	Count
Romb	2

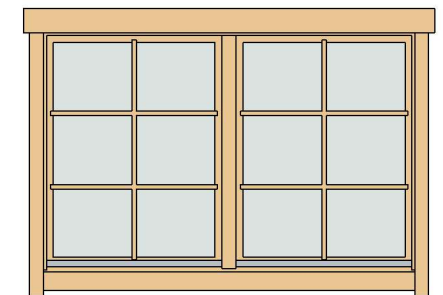



Montana 40 (380x575)

List of all items 1



Impregnated foundation beams

Mark	Type	Profile	Count	Length
------	------	---------	-------	--------

IFB1	IFB 70x40		2	5740
IFB2	IFB 70x40		12	3650
IFB3	IFB 70x40		2	487

Floor Schedule

Mark	Type	Profile	Count	Length
------	------	---------	-------	--------





FB	FB 18x110		35	3316
TB1	TB 21x95		21	2310
TB2	TB 21x95		18	2350

BB1	BB 20x40		2	3800
-----	----------	---	---	------

BB2	BB 20x40		2	3400
-----	----------	--	---	------



Fascia Schedule

Mark	Type	Profile	Count	Length
------	------	---------	-------	--------

EE	Eave Edging 18x90		4	2320
RF	Facia 18x115		4	2320
RR1	Roof reinforcement 18x90		4	2975
RR2	Roof reinforcement 38x38		4	2975

Roof

Mark	Type	Profile	Count	Length
------	------	---------	-------	--------

RFR	Ridge 40x143		1	5950
RFB	Beam 40x143		4	5950
RB	RoofBoard 18x110		110	2280

Montana 40 (380x575)

List of all items 2

Wall 1			
Mark	Profile	Count	Cut Length

1BL 1	40x57	2	1200
1LG 1	40x114	32	300
1LG 2*	40x114	1	839
1LG 3	40x114	4	1200
1LG 4*	40x114	1	1679
1LG 5*	40x114	1	2454
1LG 6*	40x114	1	3358
1LG 7*	40x114	1	4000
1LG 8	40x114	2	4000
1LG 9	40x114	2	1200

Wall 2			
Mark	Profile	Count	Cut Length

2BL 1	40x57	1	600
2BL 2	40x57	1	1960
2LG 1	40x114	9	590
2LG 2	40x114	26	600
2LG 3*	40x114	1	839
2LG 4*	40x114	1	1679
2LG 5	40x114	8	1960
2LG 6*	40x114	1	2454
2LG 7*	40x114	1	3358
2LG 8*	40x114	1	4000
2LG 9	40x114	1	4000

*Gable-delivered premounted

Wall 3			
Mark	Profile	Count	Cut Length

3BL 1	40x57	1	4000
3LG 1*	40x114	1	839
3LG 2*	40x114	1	1679
3LG 3*	40x114	1	2454
3LG 4*	40x114	1	3358
3LG 5*	40x114	1	4000
3LG 6	40x114	18	4000

Log Profiles 1	
Profile	Profile

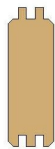
40x57	
40x114	

Montana 40 (380x575)

List of all items 3

Wall A			
Mark	Profile	Count	Cut Length

ALG 1	40X114	13	300
ALG 2	40X114	3	300
ALG 3	40X114	18	1030
ALG 4	40X114	4	3600
ALG 5	40X114	4	5950
ALG 6	40X114	1	5950
ATL 1	40X122	1	5950

Wall B			
Mark	Profile	Count	Cut Length

BLG 1	40X114	13	300
BLG 2	40X114	3	300
BLG 3	40X114	13	3600
BLG 4	40X114	4	5950
BLG 5	40X114	1	5950
BTL 1	40X122	1	5950



Wall AA			
Mark	Profile	Count	Cut Length

AALG 1	40X114	6	300
AATL 1	40X57	1	300

Wall AB			
Mark	Profile	Count	Cut Length

ABLG 1	40X114	6	300
ABTL 1	40X57	1	300

Log Profiles 2	
Profile	Profile

40X57	
40X114	
40X122	