

Aida 40 (734x576)

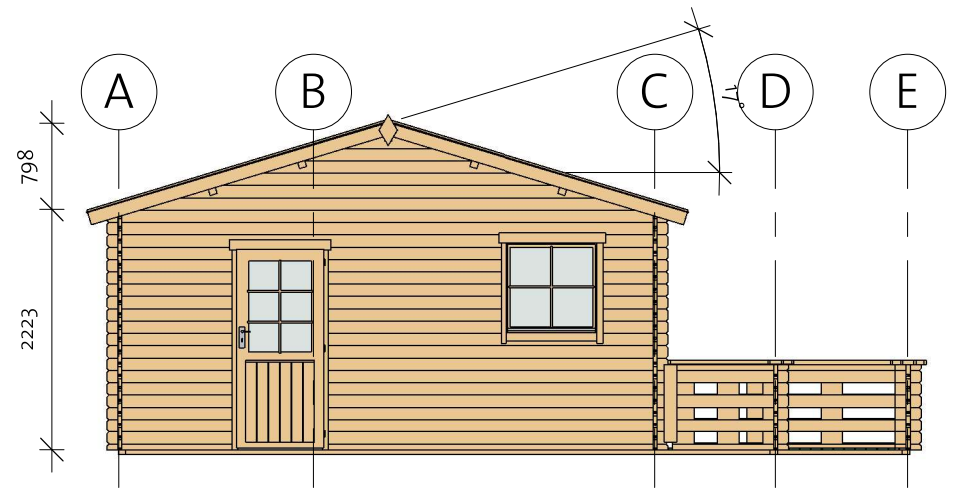

Aida 40 (734x576)

Foundation

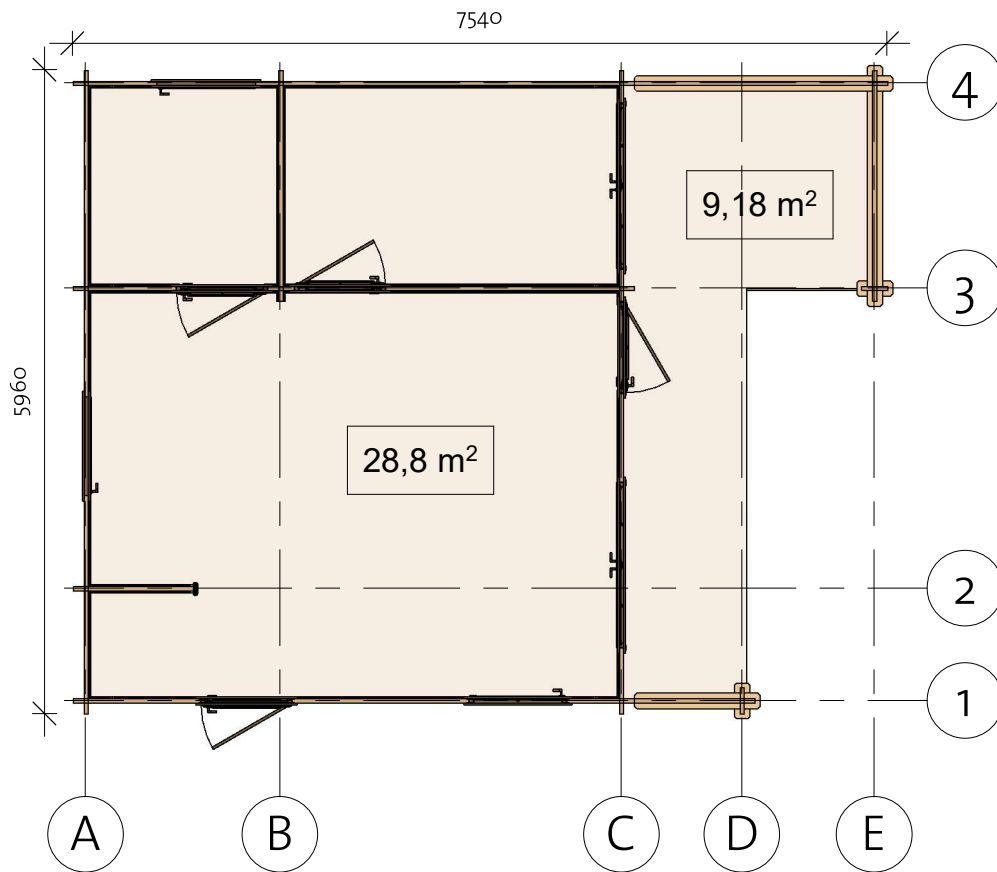
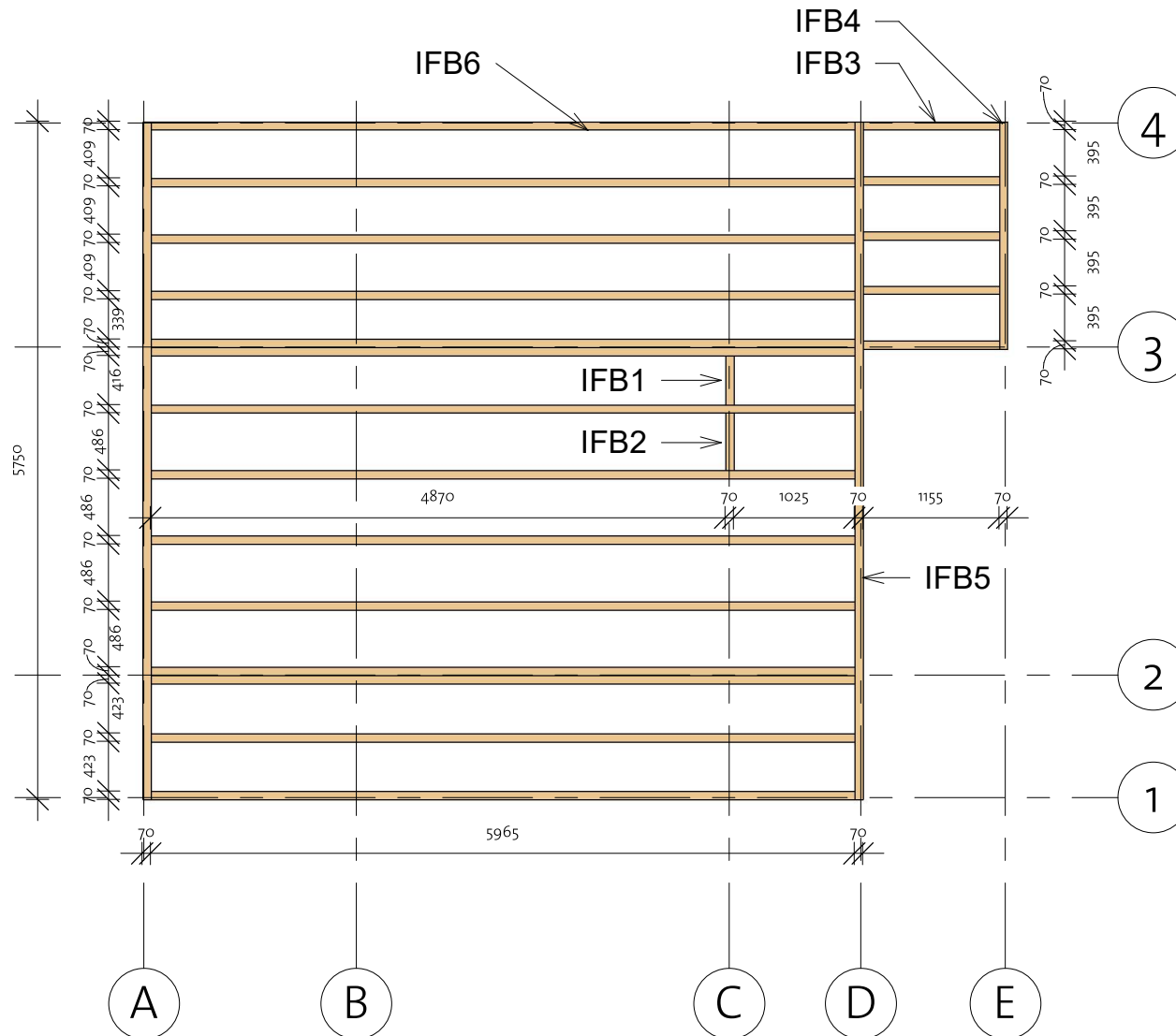

Impregnated foundation beams				
Mark	Type	Profile	Count	Length
IFB1	IFB	70x40	1	416
IFB2	IFB	70x40	1	486
IFB3	IFB	70x40	5	1155
IFB4	IFB	70x40	1	1931
IFB5	IFB	70x40	2	5750
IFB6	IFB	70x40	14	5965

Aida 40 (734x576)

Floor Plan

I Baseboard

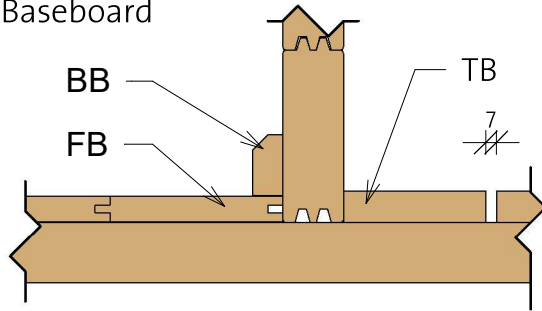

Floor Schedule

Mark	Type	Profile	Count	Length
FB1	FB 17x114		9	997
FB2	FB 17x114		44	1858
FB3	FB 17x114		35	3776
FB4	FB 17x114		9	2736
TB1	TB 21x95		12	5677
TB2	TB 21x95		14	1901

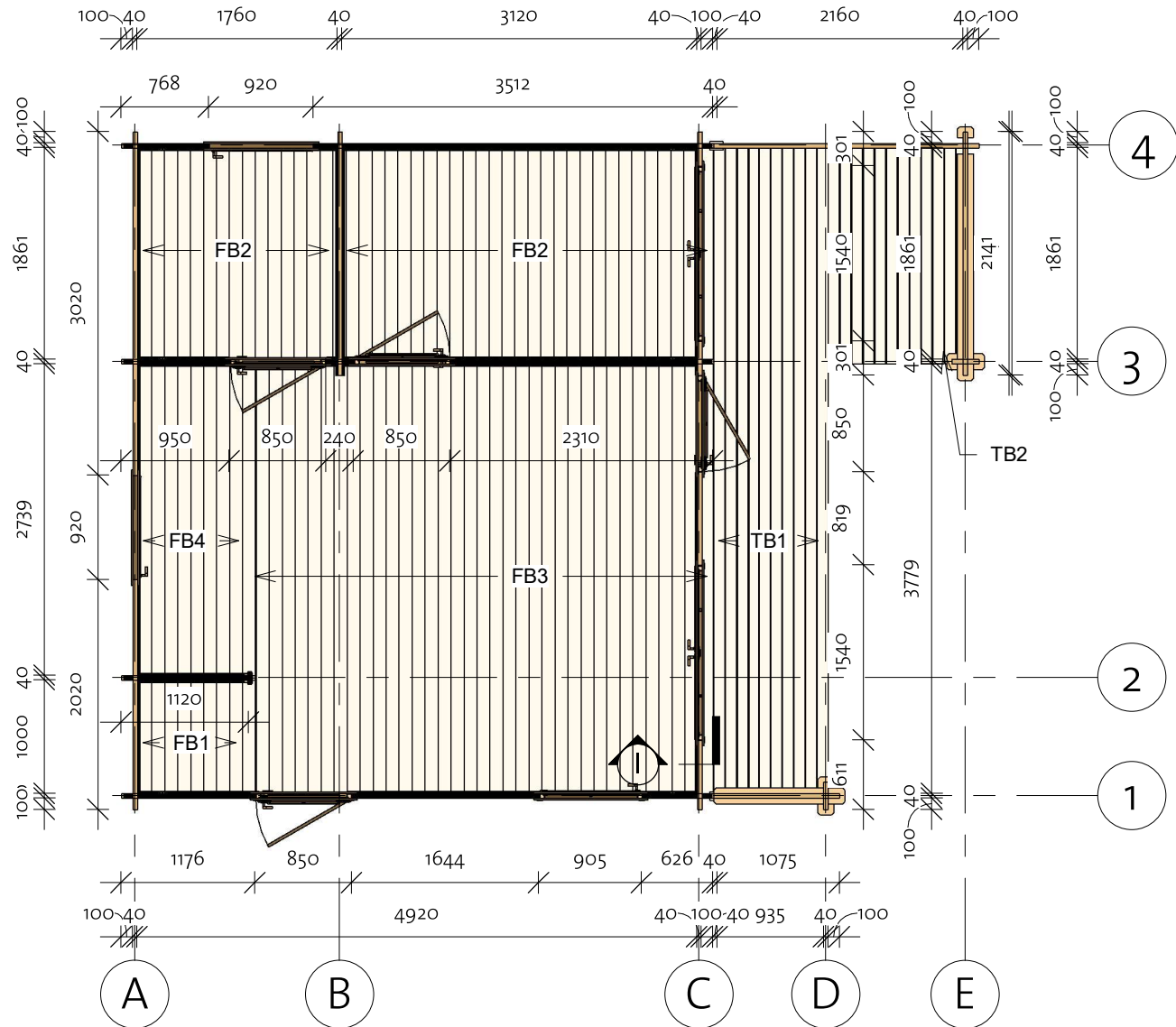

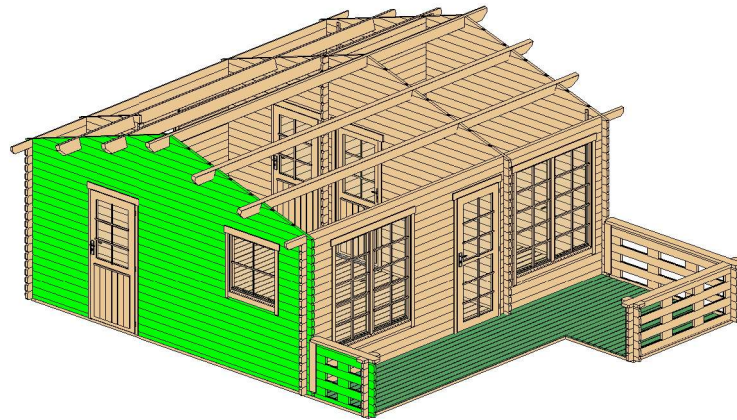

Aida 40 (734x576)

Wall 1



Log Profile Wall 1	
Profile	Profile

40x57	
40x114	
40x53	

Wall 1			
Mark	Profile	Count	Cut Length

1BL-1	40x57	1	1075
1BL-2	40x57	1	1176
1BL-3	40x57	1	3174
1LG-1	40x114	3	240
1LG-2	40x114	6	200
1LG-3	40x114	8	623
1LG-4 *	40x114	1	761
1LG-5	40x114	3	1075
1LG-6	40x53	1	1075
1LG-7	40x114	16	1176
1LG-8 *	40x114	1	1517
1LG-9	40x114	7	1641
1LG-10*	40x114	1	2273
1LG-11 *	40x114	1	3029
1LG-12	40x114	9	3174
1LG-13	40x114	1	3667
1LG-14*	40x114	1	3786
1LG-15*	40x114	1	4542
1LG-16*	40x114	1	5192
1LG-17	40x114	2	5200

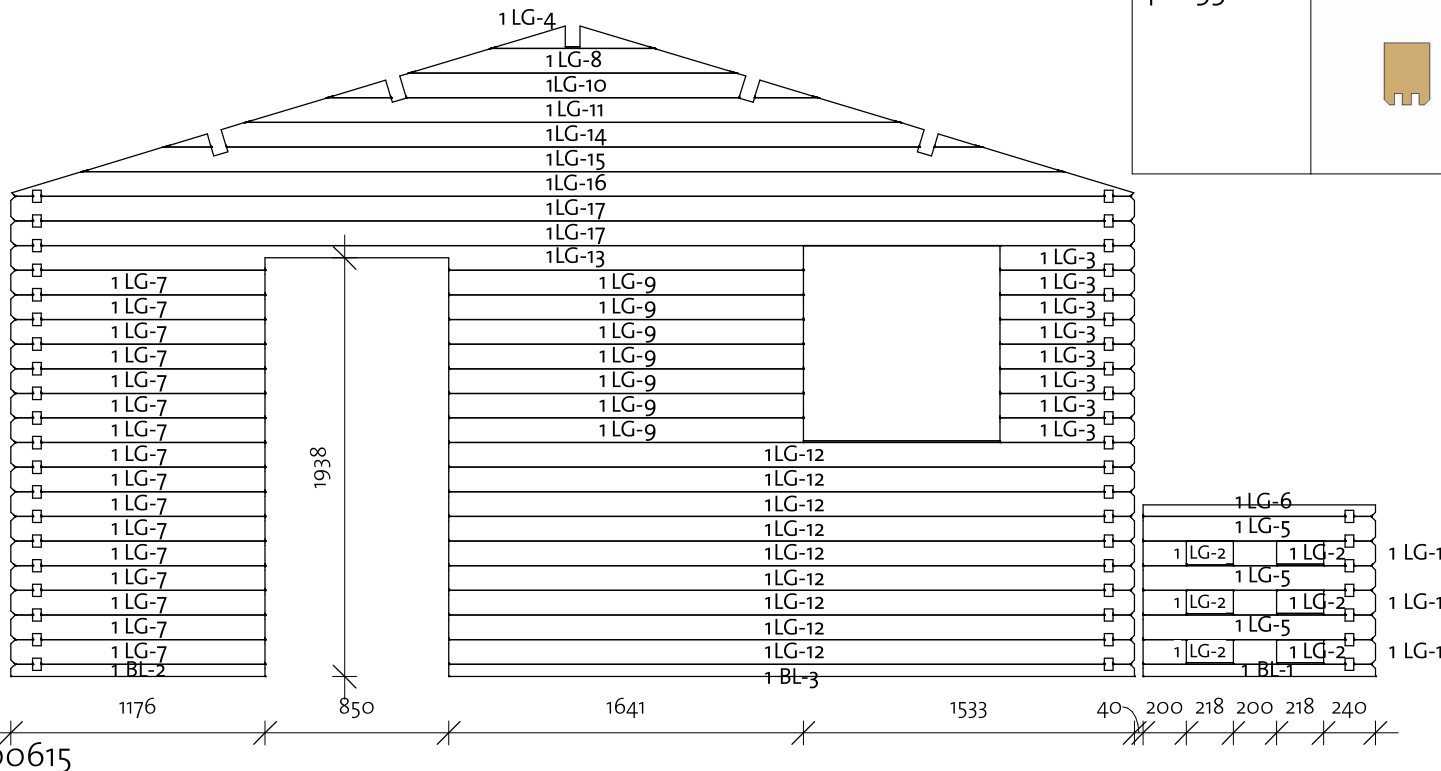

* Gable - delivered premounted

Aida 40 (734x576)

Wall 2

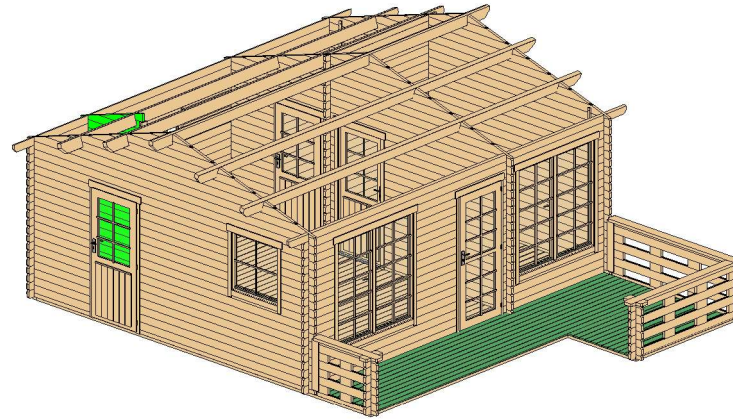

Wall 2			
Mark	Profile	Count	Cut Length

2BL-1	40X57	1	1120
2LG-1 *	40X114	1	413
2LG-2 *	40X114	1	791
2LG-3	40X114	19	1120
2LG-4 *	40X114	1	1116

* Gable - delivered premounted

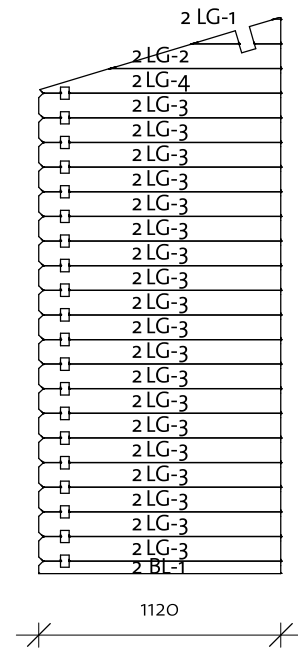

Log Profile Wall 2	
Profile	Profile



40X57	
40X114	

Aida 40 (734x576)

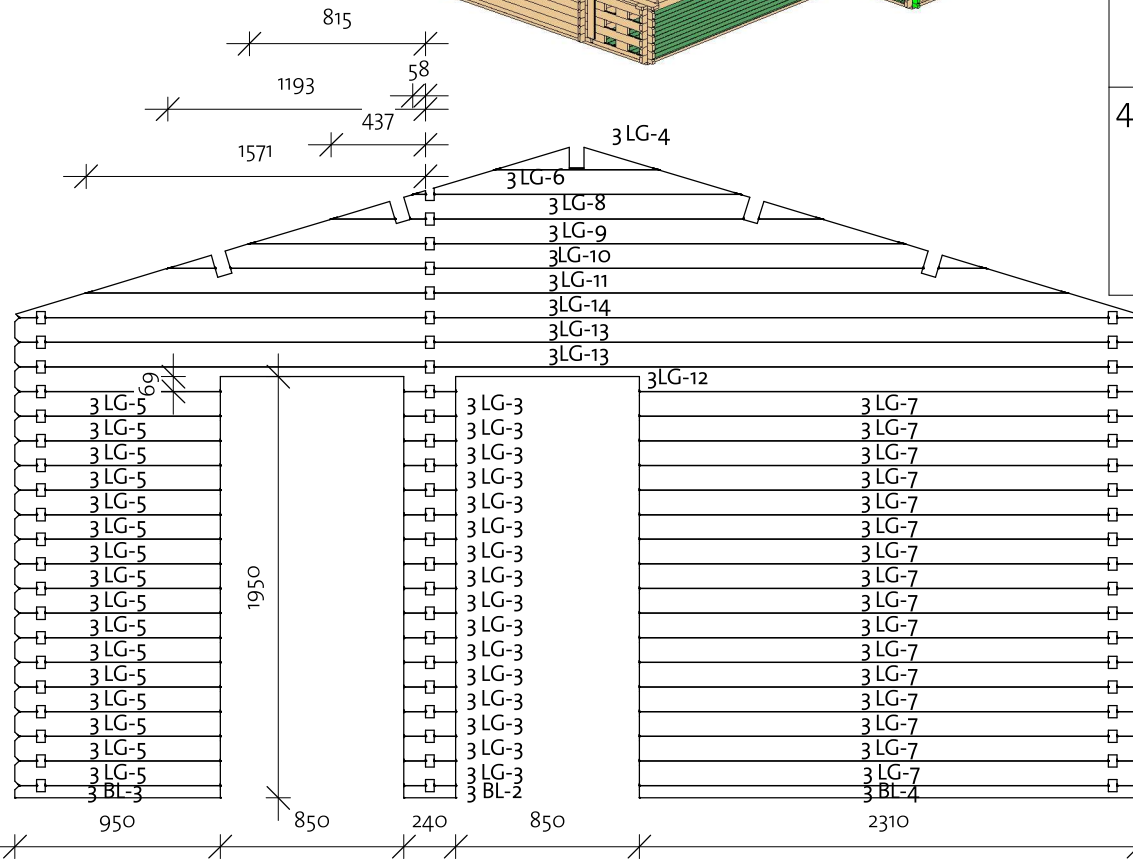
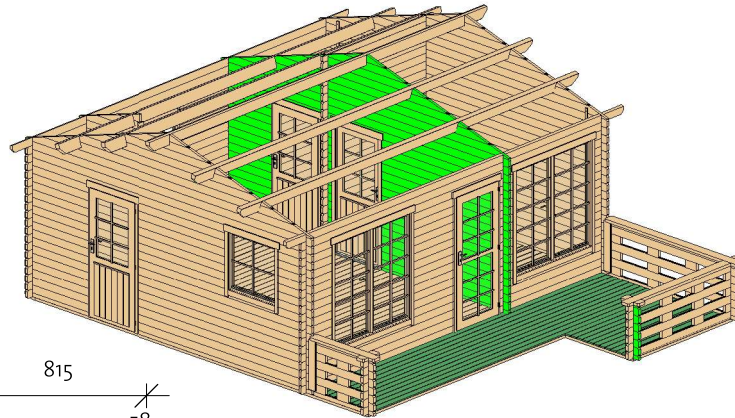
Wall 3



Log Profile Wall 3	
Profile	Profile

40x57	
40x114	
40x53	

Wall 3			
Mark	Profile	Count	Cut Length

3BL-1	40x57	1	240
3BL-2	40x57	1	240
3BL-3	40x57	1	950
3BL-4	40x57	1	2310
3LG-1	40x114	6	240
3LG-2	40x53	1	240
3LG-3	40x114	16	240
3LG-4 *	40x114	1	761
3LG-5	40x114	16	950
3LG-6 *	40x114	1	1517
3LG-7	40x114	16	2310
3LG-8 *	40x114	1	2273
3LG-9 *	40x114	1	3029
3LG-10 *	40x114	1	3786
3LG-11 *	40x114	1	4542
3LG-12	40x114	1	5200
3LG-13	40x114	2	5200
3LG-14 *	40x114	1	5192

* Gable - delivered premounted

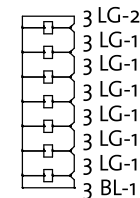



Aida 40 (734x576)

Wall 4

Log Profile Wall 4	
Profile	Profile

Log Profile Wall 4	
Profile	Profile

40x57	
40x114	

40x53	
-------	---

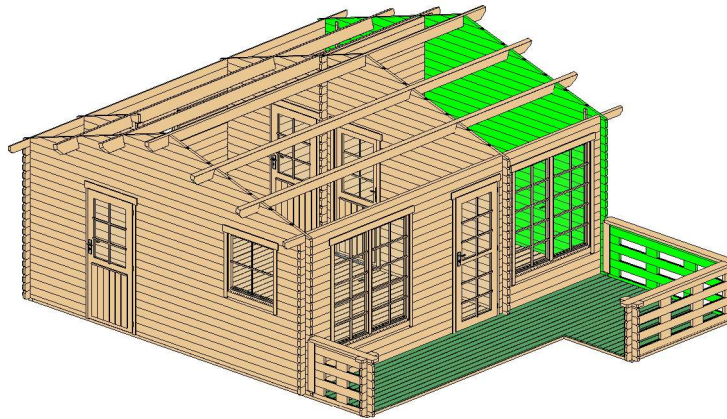

Wall 4			
Mark	Profile	Count	Cut Length

4BL-1	40x57	1	2300
4BL-2	40x57	1	5200
4LG-1	40x114	9	200
4LG-2	40x114	3	240
4LG-3 *	40x114	1	761
4LG-4	40x114	4	768
4LG-5 *	40x114	1	1517
4LG-6 *	40x114	1	2273
4LG-7	40x114	3	2300
4LG-8	40x53	1	2300
4LG-9 *	40x114	1	3029
4LG-10	40x114	4	3512
4LG-11 *	40x114	1	3786
4LG-12 *	40x114	1	4542
4LG-13	40x114	15	5200
4LG-14 *	40x114	1	5192

* Gable - delivered premounted

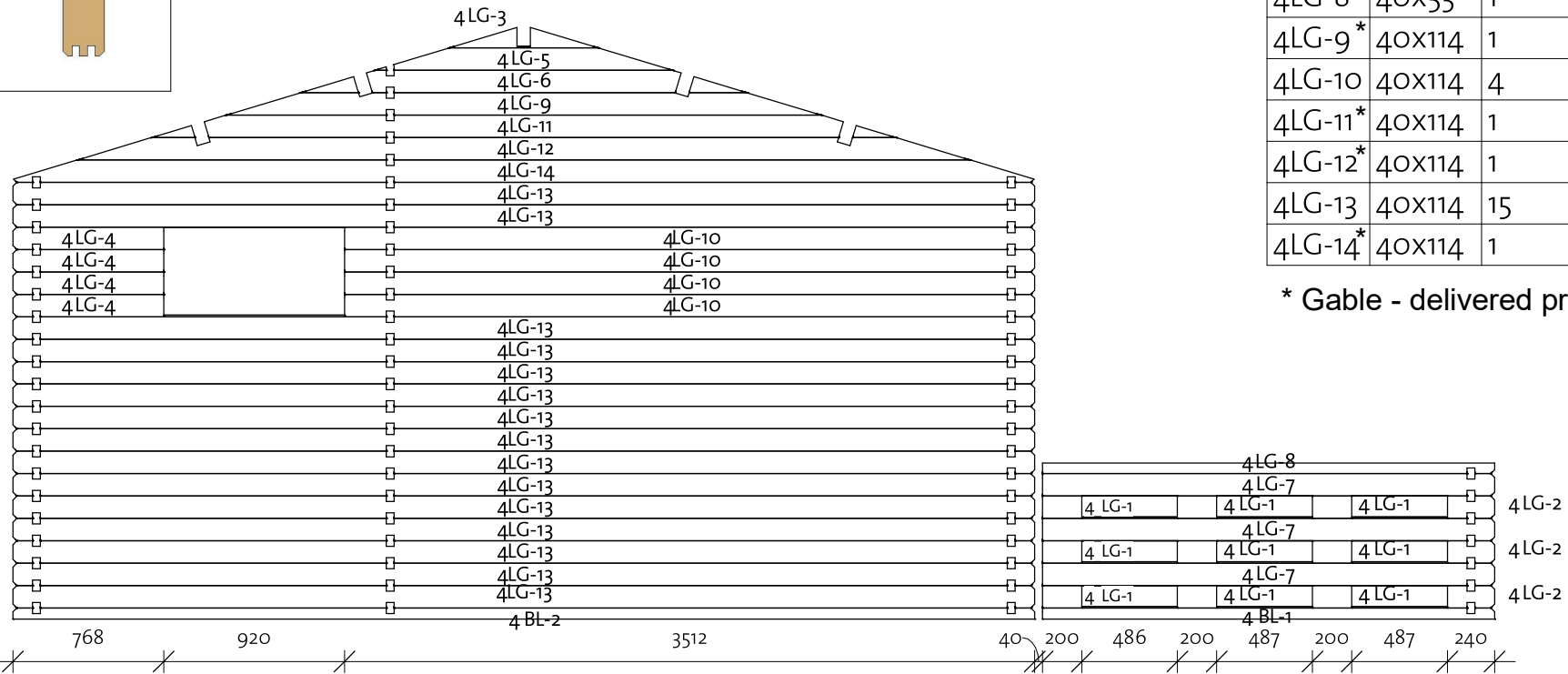

200729

Aida 40 (734x576)

Wall A

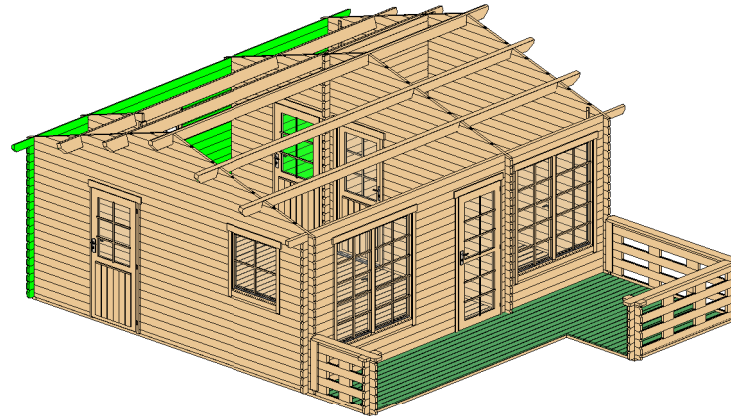

Wall A			
Mark	Profile	Count	Cut Length

ALG-1	40x114	14	5960
ALG-2	40x114	4	2020
ALG-3	40x114	4	3020
ALG-4	40x114	1	5960
ATL-1	40x114	1	2311
ATL-2	40x114	1	4229

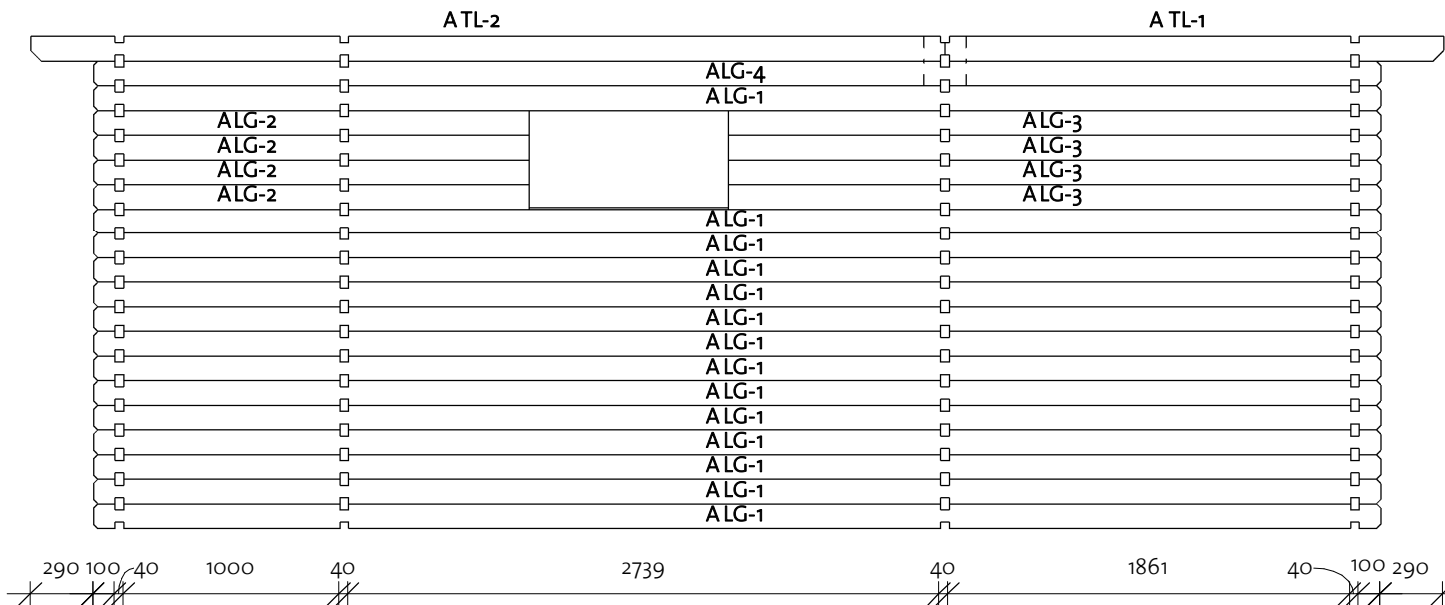

Log Profile Wall A	
Profile	Profile

40x114	
40x114	

Aida 40 (734x576)

Wall B

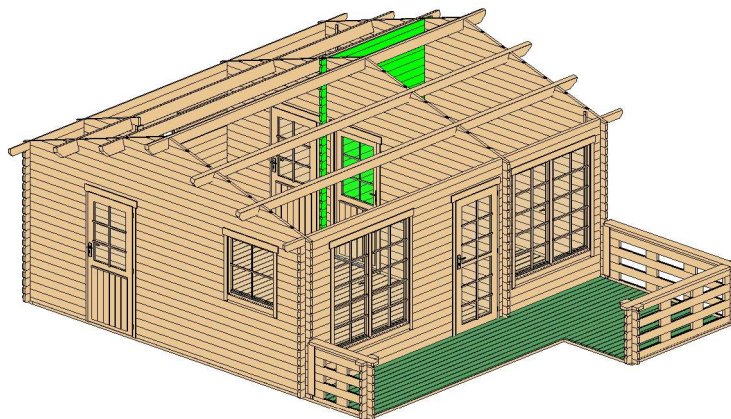

Wall B			
Mark	Profile	Count	Cut Length

BLG-1	40x114	24	2141
BTL-1	40x88	1	2141

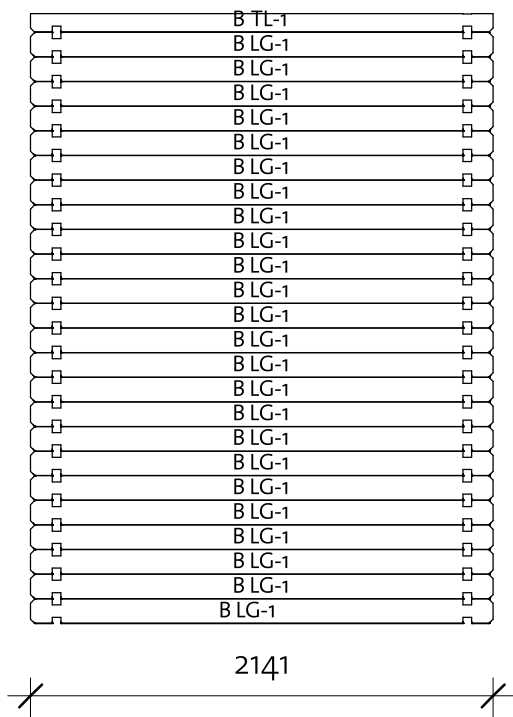

Log Profile Wall B	
Profile	Profile

40x88	
40x114	

Aida 40 (734x576)

Wall C

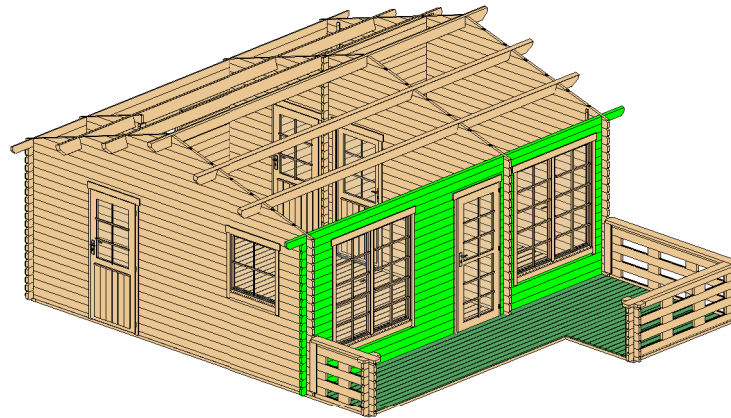

Wall C			
Mark	Profile	Count	Cut Length

CTL-1	40X114	1	2311
CTL-2	40X114	1	4229
CLG-1	40X114	14	300
CLG-2	40X114	13	301
CLG-3	40X114	14	611
CLG-4	40X114	13	819
CLG-5	40X114	1	1970
CLG-6	40X114	4	2141
CLG-7	40X114	4	2970
CLG-8	40X114	1	5960

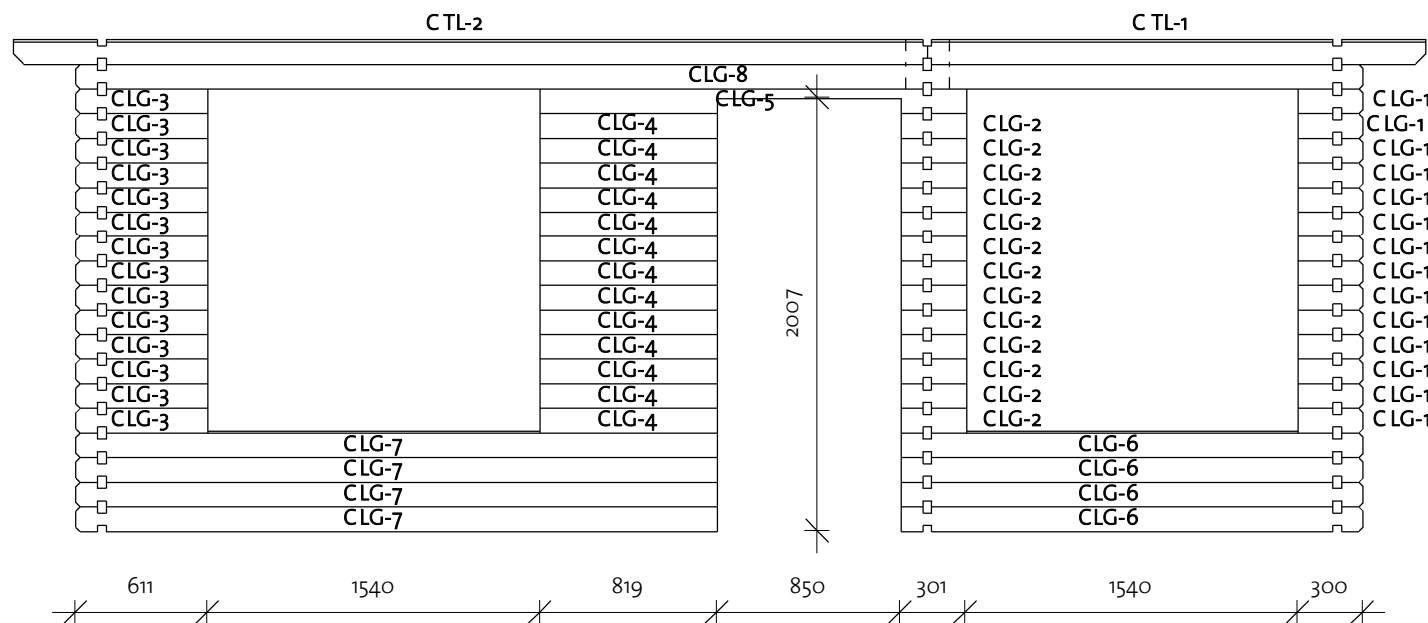

Log Profile Wall C	
Profile	Profile

40X114	
40X114	

Aida 40 (734x576)

Wall D

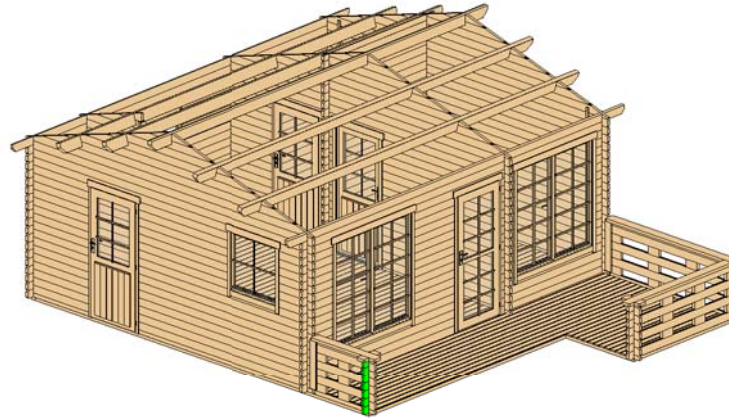

Wall D			
Mark	Profile	Count	Cut Length

DLG-1	40x114	6	240
DLG-2	40x110	1	240

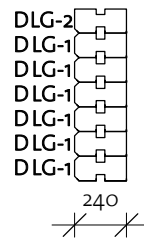

Log Profile Wall D	
Profile	Profile

40X114	
40X110	

Aida 40 (734x576)

Wall E

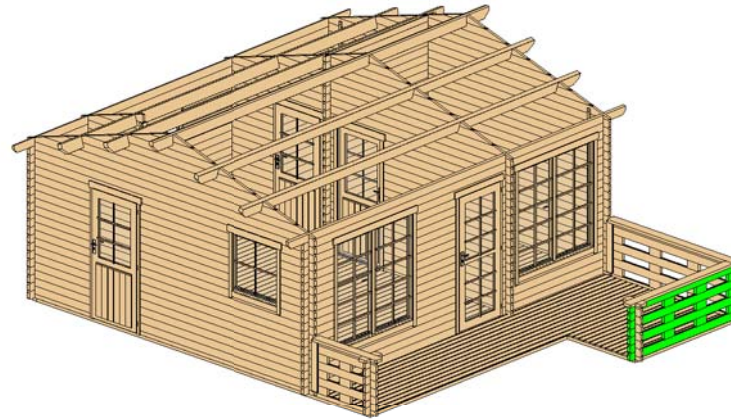

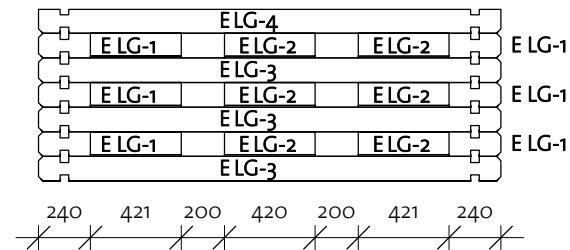

Wall E			
Mark	Profile	Count	Cut Length

ELG-1	40x114	6	240
ELG-2	40x114	6	200
ELG-3	40x114	3	2141
ELG-4	40x110	1	2141







Log Profile Wall E	
Profile	Profile

40x114	
40x110	





Aida 40 (734x576)

Roof 1

H - profile		
Type	Count	Length
H-profile	2	720

Roof				
Mark	Type	Profile	Count	Length
RFR	Ridge 68x160		1	6540
RFB1	Beam 68x160		3	6540
RFB2	Beam 68x160		1	6540
RB	17x114		118	2851

H-profile	2	720
-----------	---	-----

RFR	Ridge 68x160		1	6540
RFB1	Beam 68x160		3	6540
RFB2	Beam 68x160		1	6540
RB	17x114		118	2851

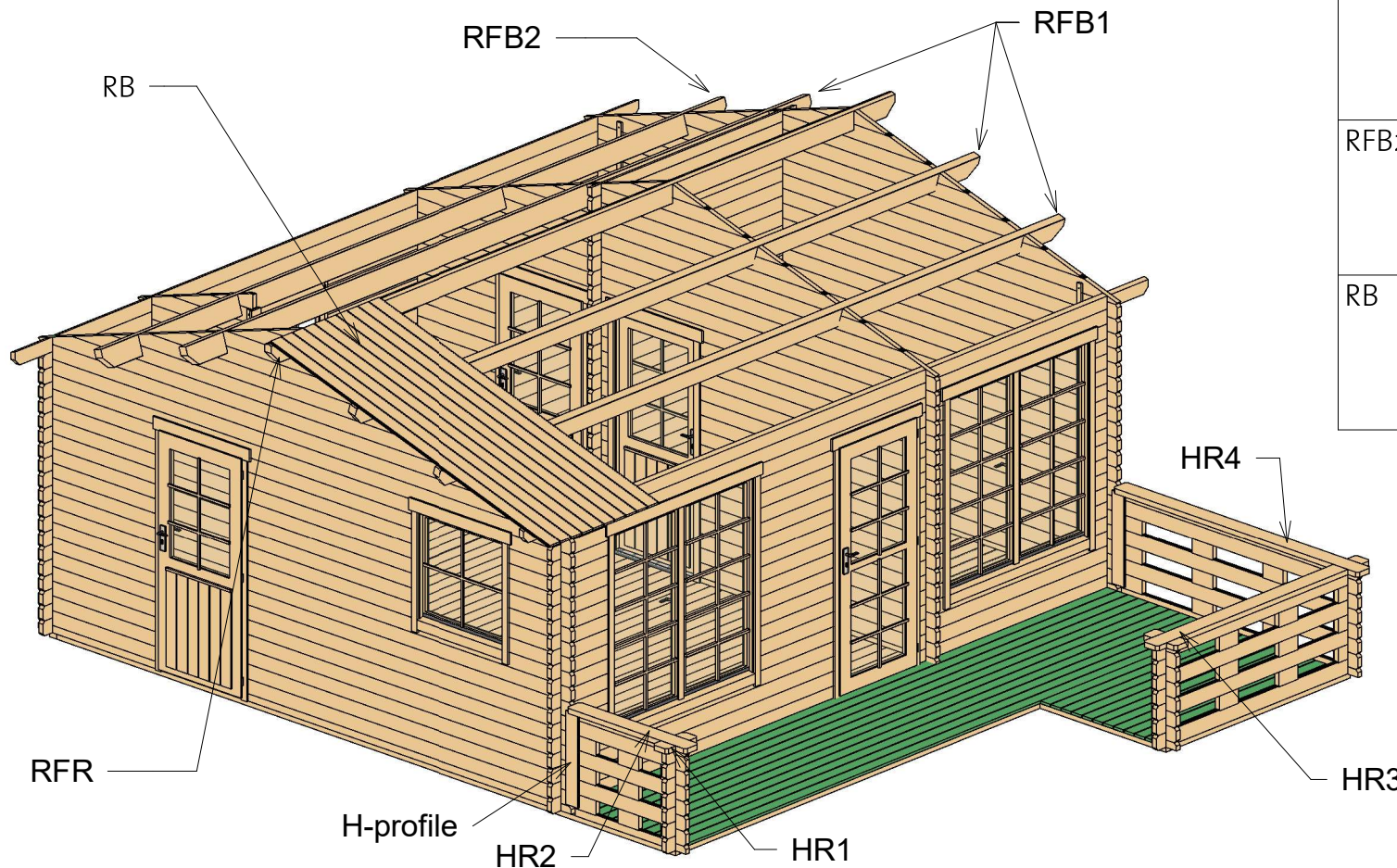

Handrails 143 x 40			
Mark	Type	Count	Length
HR1	Handrail 1	5	94
HR2	Handrail 2	1	1161
HR3	Handrail 3	1	1995
HR4	Handrail 4	1	2386

HR1	Handrail 1	5	94
HR2	Handrail 2	1	1161
HR3	Handrail 3	1	1995
HR4	Handrail 4	1	2386

Aida 40 (734x576)

Roof 2

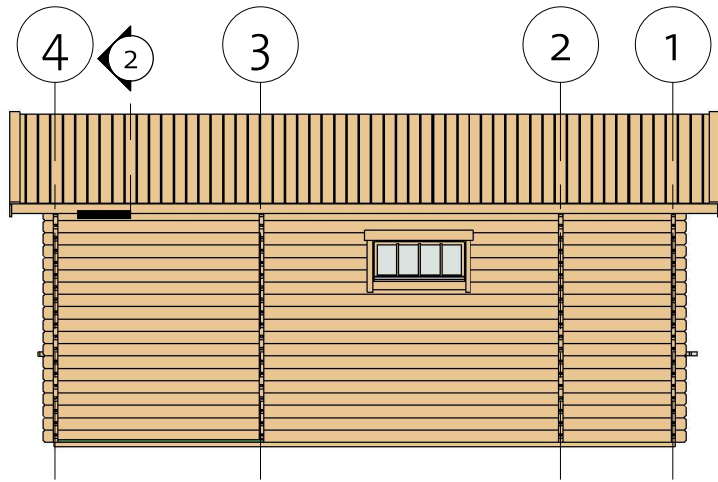

② Fascia

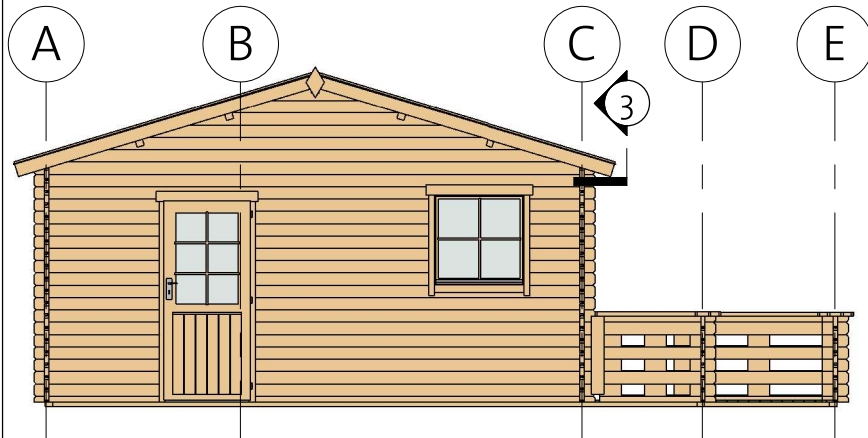
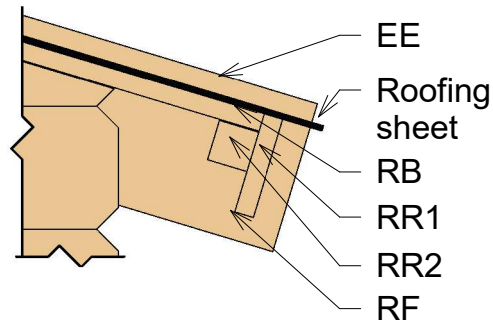

③ Roof Reinforcement

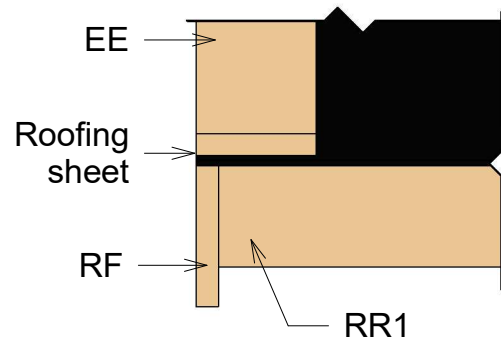

Fascia Schedule				
Mark	Type	Profile	Count	Length
EE	Eave Edging 18x95		4	2901
RF	Roof Fascia 18x120		4	2901
RR1	Roof reinforcement 18x95		4	3270
RR2	Roof reinforcement 38x38		4	3270

Aida 40 (734x576)

Extras



Door Schedule				
Mark	Type	Width	Height	Count
CD1R	Classic door 1 right	840	1890	3
CD3R	Classic door 3, two glass right	840	1955	1
DCB6	Door Crossbar 6	--	--	3
DB	Door beam 850 mm	40	12	3

Window Schedule				
Mark	Type	Width	Height	Count
CDW4	Classic double window 4	1530	1555	2
CW5R	Classic window 5 right	915	420	2
CW8R	Classic window 8 right	900	870	1
WCB10	Windows Crossbar 10	--	--	4
WCB4	Windows Crossbar 4	--	--	1

Fasteners & Extras		
Name	Type	Count

Hitblock	300-400 mm	
Bolts	M8 x 90	3
Bolts	M8 x 70	18
Screws	5,0 x 70	40
Screws	4,0 x 40	120
Screws	6,0 x 140	140
Nails	1,4 x 40	150
Screws	4,0 x 50	1650

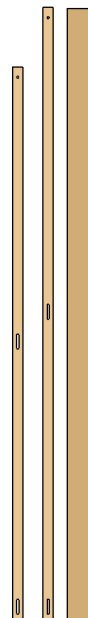





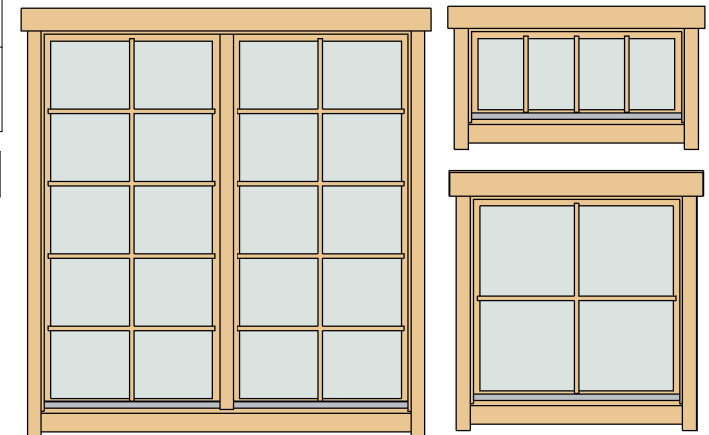

Type	Count	Length
Windboard1 18x40	6	2200
Windboard2 18x40	2	2435
Board 18x76	1	2435



Family	Count
Romb	2



Aida 40 (734x576)

List of all items 1





Impregnated foundation beams				
Mark	Type	Profile	Count	Length
IFB1	IFB 70x40		1	416
IFB2	IFB 70x40		1	486
IFB3	IFB 70x40		5	1155
IFB4	IFB 70x40		1	1931
IFB5	IFB 70x40		2	5750
IFB6	IFB 70x40		14	5965

Floor Schedule				
Mark	Type	Profile	Count	Length
FB1	FB 17x114		9	997
FB2	FB 17x114		44	1858
FB3	FB 17x114		35	3776
FB4	FB 17x114		9	2736
TB1	TB 21x95		12	5677
TB2	TB 21x95		14	1901

Baseboard				
Mark	Type	Profile	Count	Length
BB	BB 20x40		7	6000





Aida 40 (734x576)

List of all items 2

Roof				
Mark	Type	Profile	Count	Length
RFR	Ridge 68x160		1	6540
RFB1	Beam 68x160		3	6540
RFB2	Beam 68x160		1	6540
RB	17x114		118	2851

Handrails 143 x 40			
Mark	Type	Count	Length

HR1	Handrail 1	5	94
HR2	Handrail 2	1	1161
HR3	Handrail 3	1	1995
HR4	Handrail 4	1	2386

Fascia Schedule				
Mark	Type	Profile	Count	Length
EE	Eave Edging 18x95		4	2901
RF	Roof Fascia 18x120		4	2901
RR1	Roof reinforcement 18x95		4	3270
RR2	Roof reinforcement 38x38		4	3270

H - profile		
Type	Count	Length

H-profile	2	720
-----------	---	-----

Aida 40 (734x576)

List of all items 3

Wall 1			
Mark	Profile	Count	Cut Length



1BL-1	40x57	1	1075
1BL-2	40x57	1	1176
1BL-3	40x57	1	3174
1LG-1	40x114	3	240
1LG-2	40x114	6	200
1LG-3	40x114	8	623
1LG-4 *	40x114	1	761
1LG-5	40x114	3	1075
1LG-6	40x53	1	1075
1LG-7	40x114	16	1176
1LG-8 *	40x114	1	1517
1LG-9	40x114	7	1641
1LG-10*	40x114	1	2273
1LG-11 *	40x114	1	3029
1LG-12	40x114	9	3174
1LG-13	40x114	1	3667
1LG-14*	40x114	1	3786
1LG-15*	40x114	1	4542
1LG-16*	40x114	1	5192
1LG-17	40x114	2	5200

Wall 2			
Mark	Profile	Count	Cut Length

2BL-1	40x57	1	1120
2LG-1 *	40x114	1	413
2LG-2 *	40x114	1	791
2LG-3	40x114	19	1120
2LG-4*	40x114	1	1116

* Gable - delivered premounted

Log Profiles 1	
Profile	Profile

40x57	
40x114	

Log Profiles 1	
Profile	Profile

40x53	
-------	---

Aida 40 (734x576)

List of all items 4

Wall 3			
Mark	Profile	Count	Cut Length



3BL-1	40x57	1	240
3BL-2	40x57	1	240
3BL-3	40x57	1	950
3BL-4	40x57	1	2310
3LG-1	40x114	6	240
3LG-2	40x53	1	240
3LG-3	40x114	16	240
3LG-4*	40x114	1	761
3LG-5	40x114	16	950
3LG-6*	40x114	1	1517
3LG-7	40x114	16	2310
3LG-8*	40x114	1	2273
3LG-9*	40x114	1	3029
3LG-10*	40x114	1	3786
3LG-11*	40x114	1	4542
3LG-12	40x114	1	5200
3LG-13	40x114	2	5200
3LG-14*	40x114	1	5192

Wall 4			
Mark	Profile	Count	Cut Length

4BL-1	40x57	1	2300
4BL-2	40x57	1	5200
4LG-1	40x114	9	200
4LG-2	40x114	3	240
4LG-3*	40x114	1	761
4LG-4	40x114	4	768
4LG-5*	40x114	1	1517
4LG-6*	40x114	1	2273
4LG-7	40x114	3	2300
4LG-8	40x53	1	2300
4LG-9*	40x114	1	3029
4LG-10	40x114	4	3512
4LG-11*	40x114	1	3786
4LG-12*	40x114	1	4542
4LG-13	40x114	15	5200
4LG-14*	40x114	1	5192

* Gable - delivered premounted

Log Profiles 1	
Profile	Profile

40x57	
40x114	

Log Profiles 1	
Profile	Profile

40x53	
-------	---

Aida 40 (734x576)

List of all items 5



Wall A			
Mark	Profile	Count	Cut Length

ALG-1	40X114	14	5960
ALG-2	40X114	4	2020
ALG-3	40X114	4	3020
ALG-4	40X114	1	5960
ATL-1	40X114	1	2311
ATL-2	40X114	1	4229

Wall C			
Mark	Profile	Count	Cut Length

CTL-1	40X114	1	2311
CTL-2	40X114	1	4229
CLG-1	40X114	14	300
CLG-2	40X114	13	301
CLG-3	40X114	14	611
CLG-4	40X114	13	819
CLG-5	40X114	1	1970
CLG-6	40X114	4	2141
CLG-7	40X114	4	2970
CLG-8	40X114	1	5960

Log Profiles 2	
Profile	Profile

40X53	
40X57	

Wall B			
Mark	Profile	Count	Cut Length

BLG-1	40X114	24	2141
BTL-1	40X88	1	2141

Wall D			
Mark	Profile	Count	Cut Length

DLG-1	40X114	6	240
DLG-2	40X110	1	240

Wall E			
Mark	Profile	Count	Cut Length

ELG-1	40X114	6	240
ELG-2	40X114	6	200
ELG-3	40X114	3	2141
ELG-4	40X110	1	2141

Log Profiles 2	
Profile	Profile

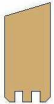
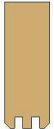
40X88	
40X110	

Log Profiles 2	
Profile	Profile

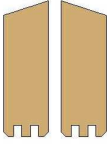
40X114	
--------	---