

# Techn. Daten Cervino

Log length (W x D) / Bohlenaußenmaß (B x T): 650 x 776 cm

Wall size(outside) / Wandaußenmaß: 630 x 756 cm

Log thickness / Bohlenstärke: 70 mm

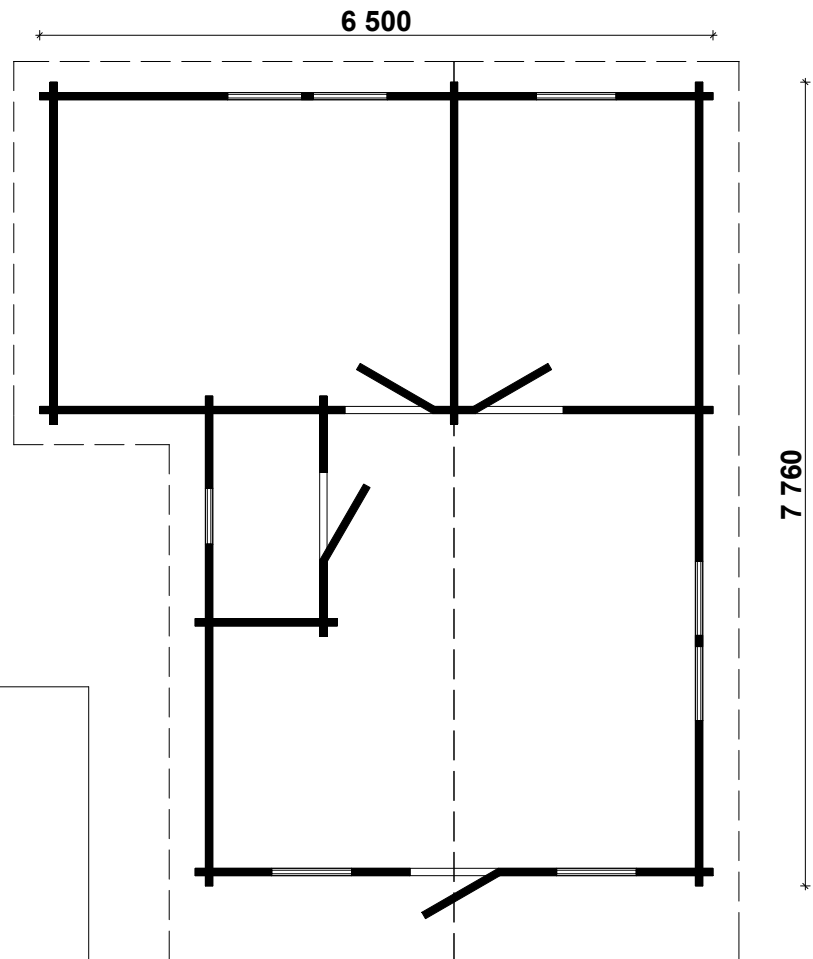

Note: All dimensions are approximate ! / Achtung : Alle angegebenen Maße sind ca. - Maße !

# Cervino 70 mm / 650 x 776 cm - Foundation / Fundamentplan

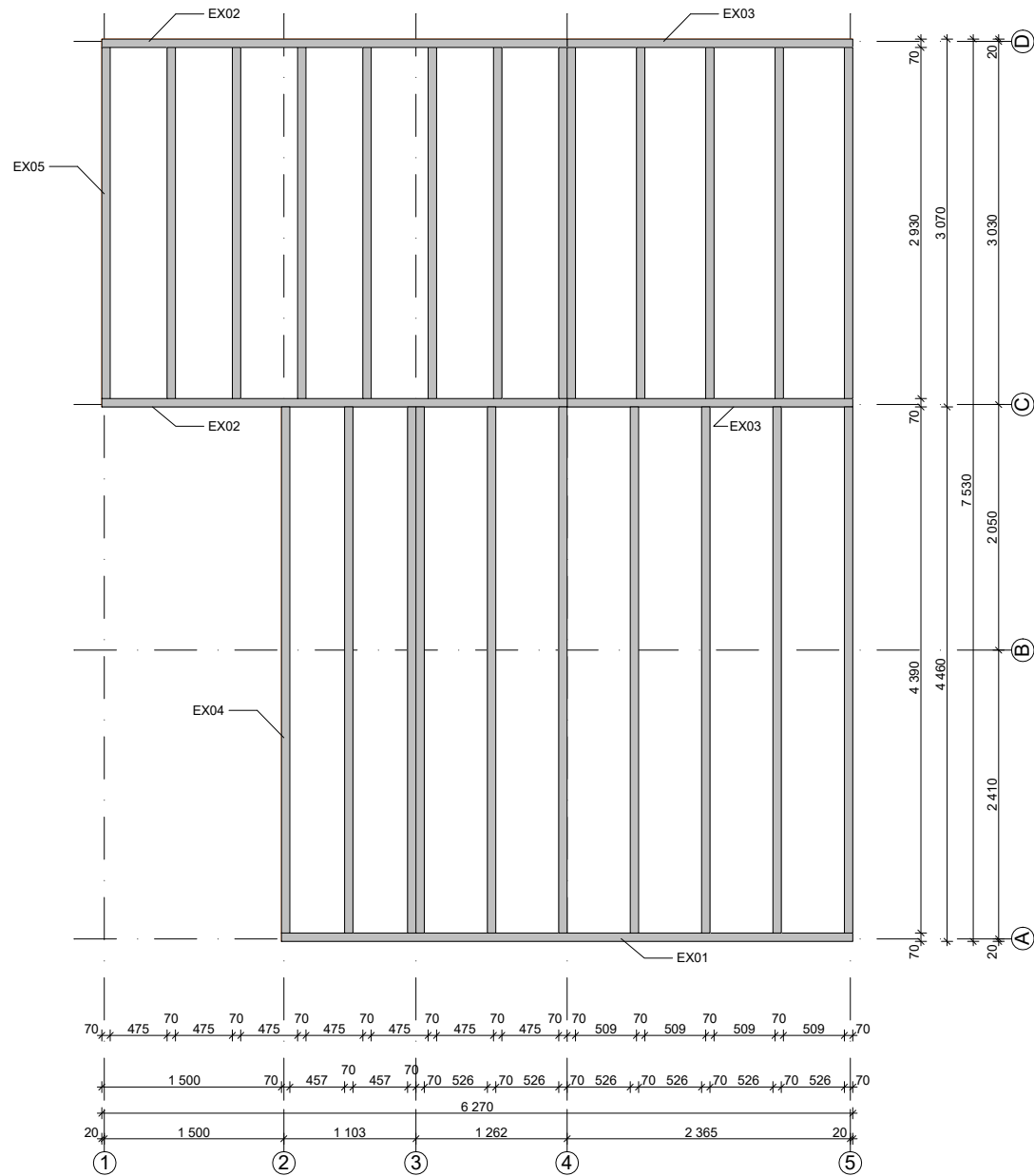



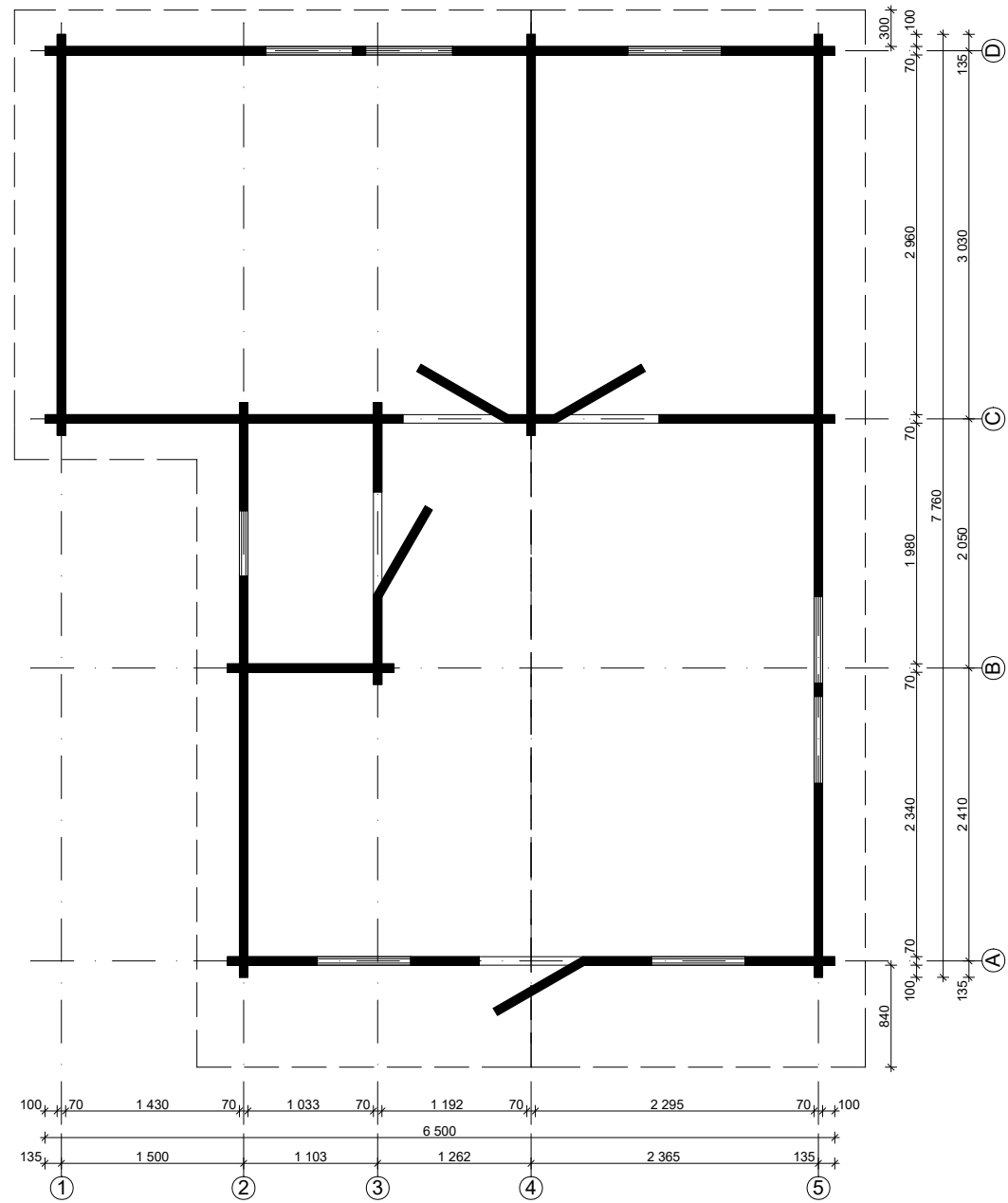







# Cervino 70 mm / 650 x 776 cm - Ground plan / Wandplan

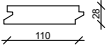
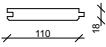

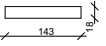
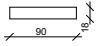
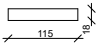
# Cervino 70 mm / 650 x 776 cm

## Specifieation / Teileliste

Nr		 mm	 mm	 x
EX01	Foundation beams / Fundamenthölzer	70 x 60	4770	1
EX02			3885	2
EX03			2385	2
EX04			4390	10
EX05			2930	13
EX06	Floor boards / Fußbodenbretter		4656	40+1
EX07			3792	27
EX08			2292	27
EX09	Roof boards / Dachbretter		4450	34+2
EX10			2880	126
EX11	Fascia board / Giebelblende 		4490	1
EX12			2920	3
EX13			1700	1
EX14	Gable edge board / Giebelabschlussbrett		4490	1
EX15			2920	3
EX16			1700	1
EX17	Eave edging / Traufenbrett		4350	2
EX18			3700	1
EX19			5380	1
EX20	Eave edging slat / Traufenleiste		2900	3
EX21			3700	1
EX22			5380	1
EX23	Diamond / Raute			2
EX24	Baseboard / Fußleisten		ca. 45,0 m	
EX25	Threaded Rod / Gewindestangen	∅ 10	2310	5
EX26			1850	2
EX27	Nut, washer / Mutter, Scheibe			14
EX28	Screws / Schrauben 4,0 x 40 ; 4,0 x 50 ; 5,0 x 100,		200/1500/110	
EX29	Nails / Nägel 1,4 x 35		100	
EX30	Dowel / Dübel	∅ 16	150	70



# Cervino 70 mm / 650 x 776 cm - A ; B

**2**

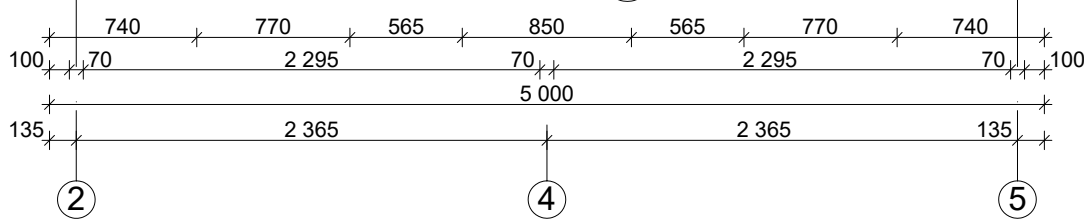
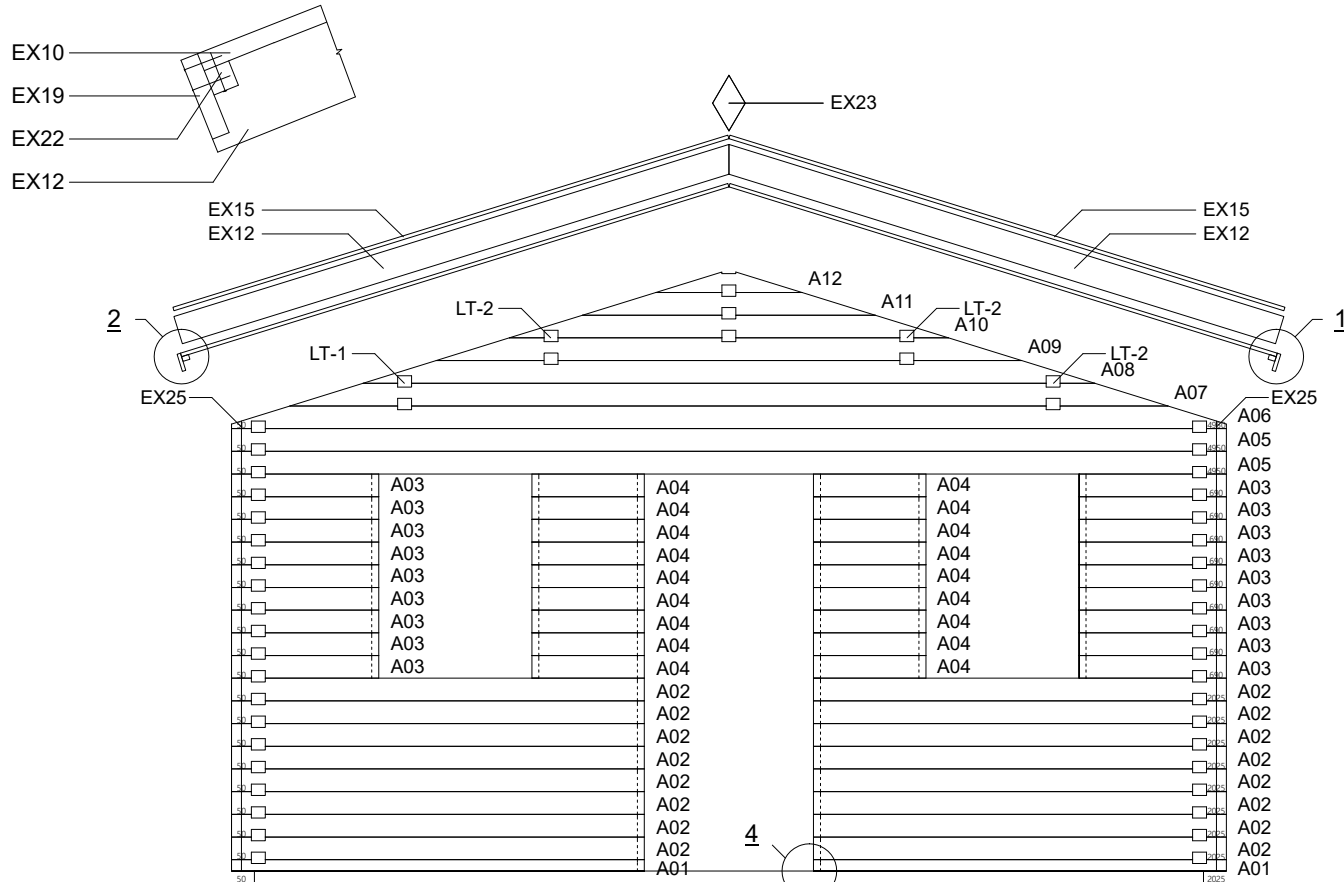

**1**

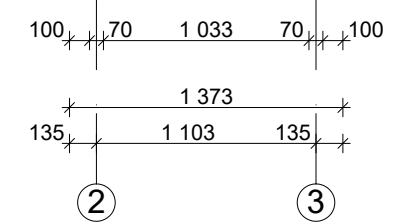
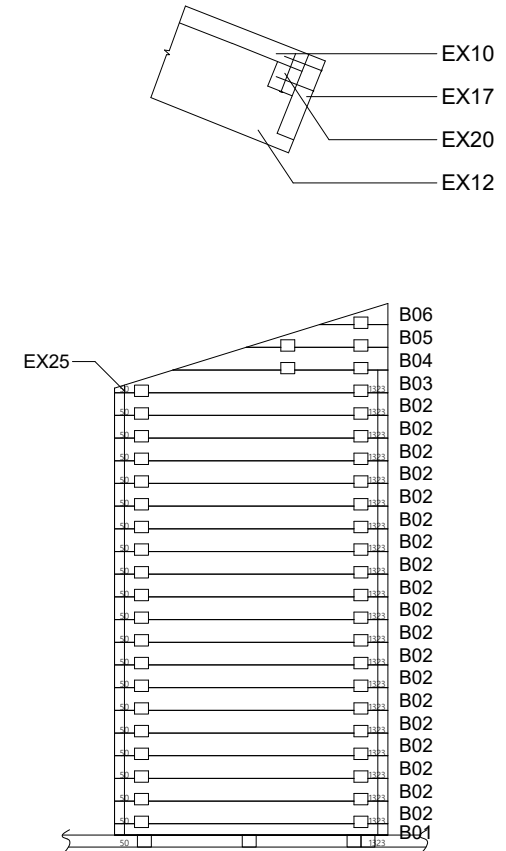

# Cervino 70 mm / 650 x 776 cm - C

**3**

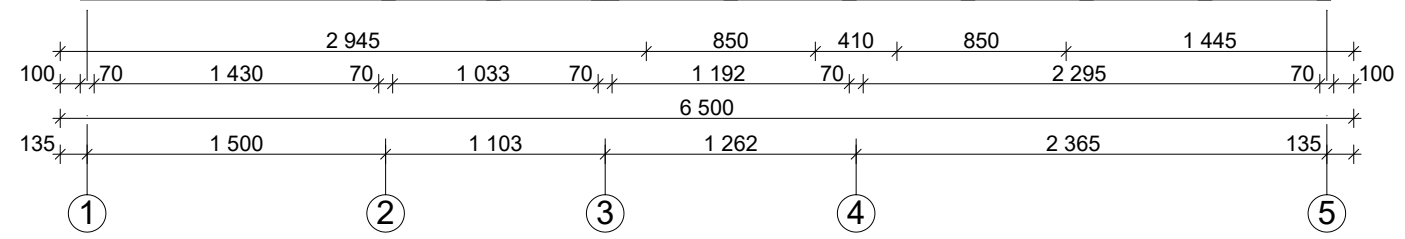
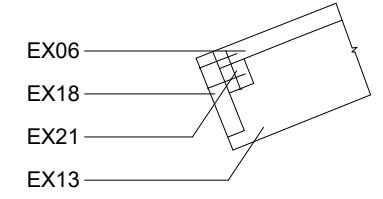
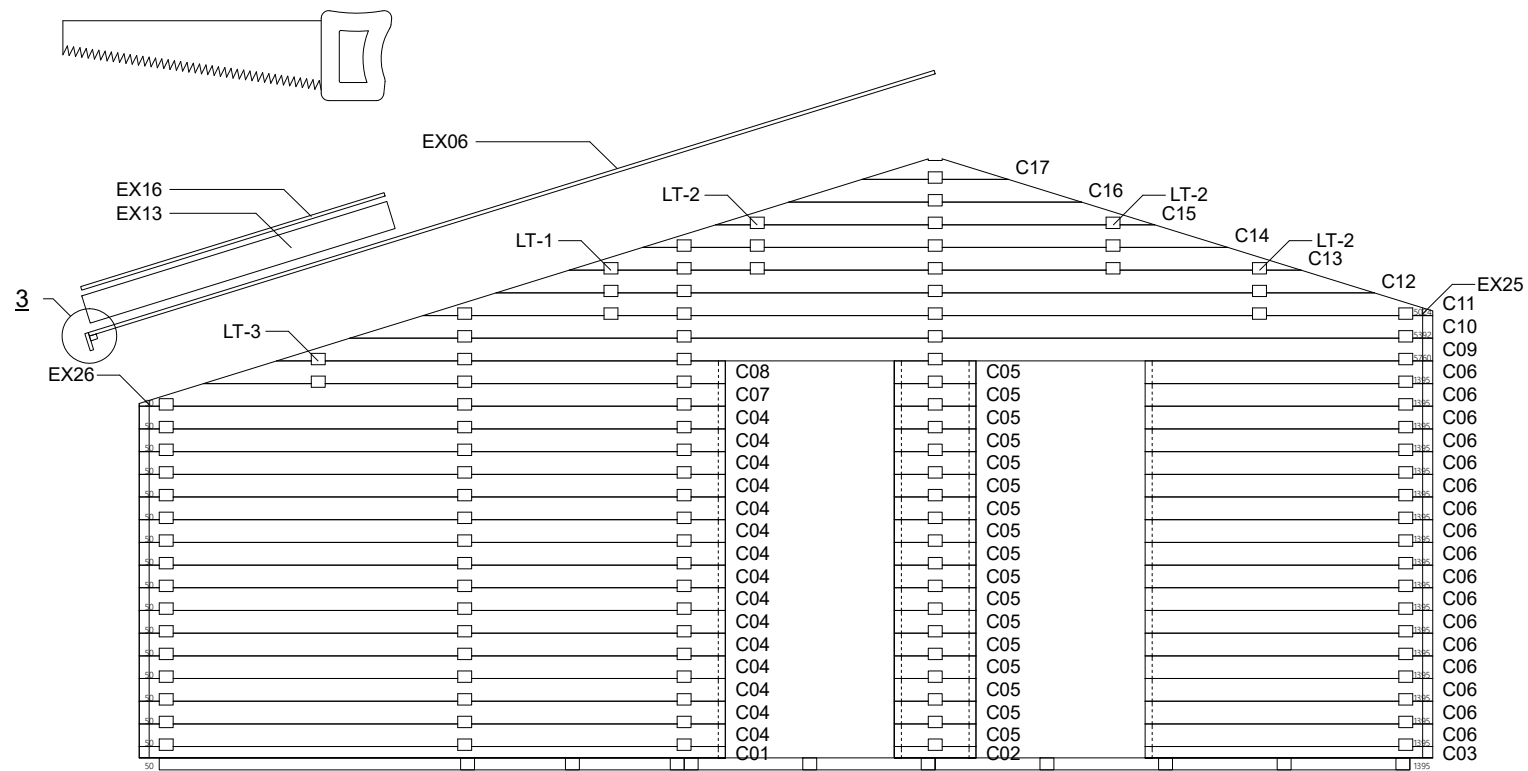

**4**

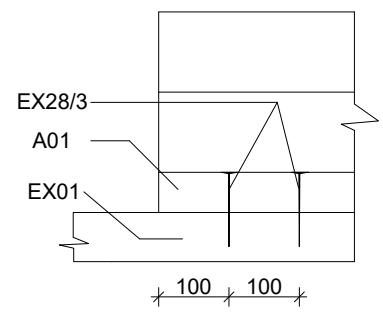

# Cervino 70 mm / 650 x 776 cm - D

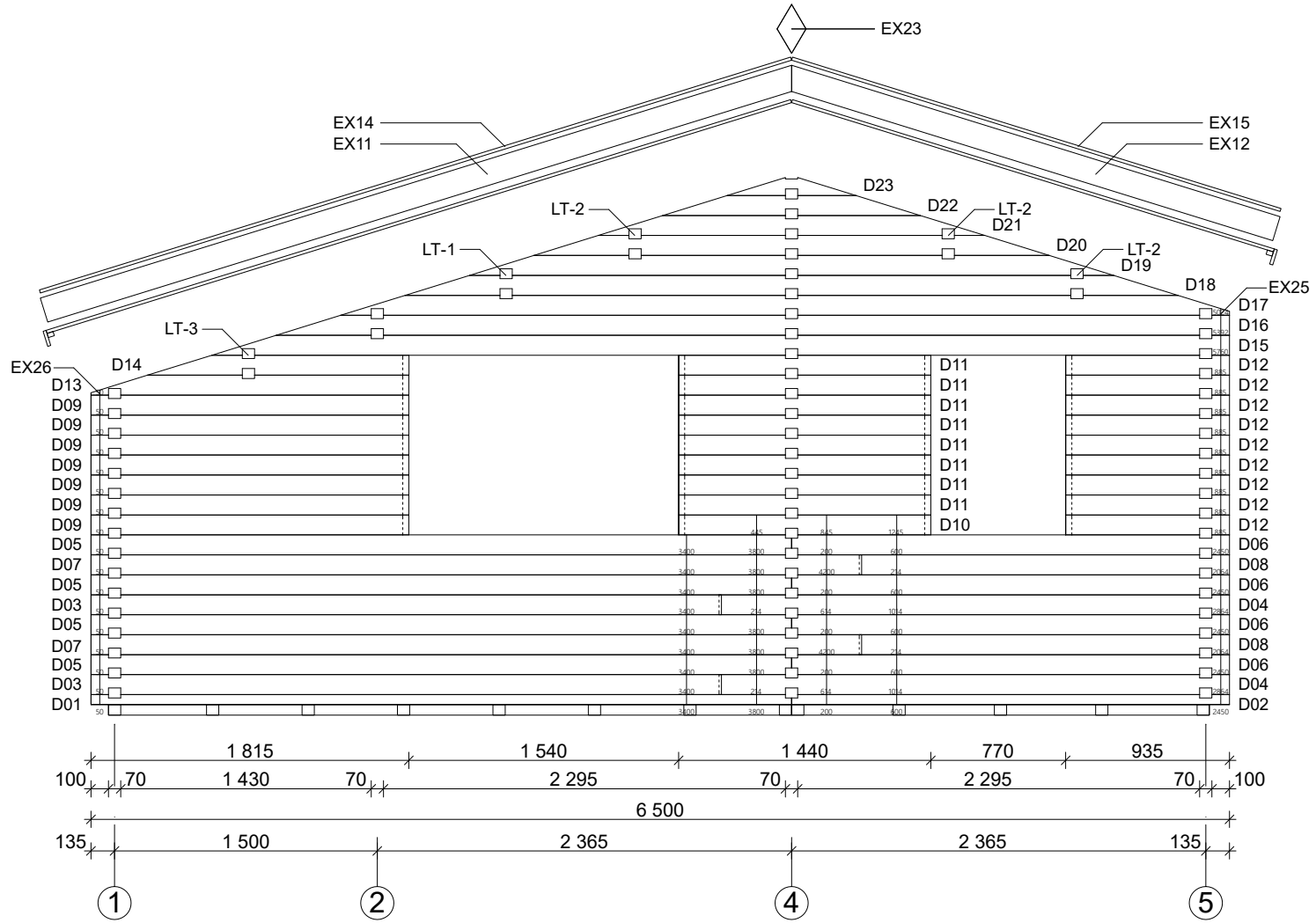



# Cervino 70 mm / 650 x 776 cm - 1 ; 3

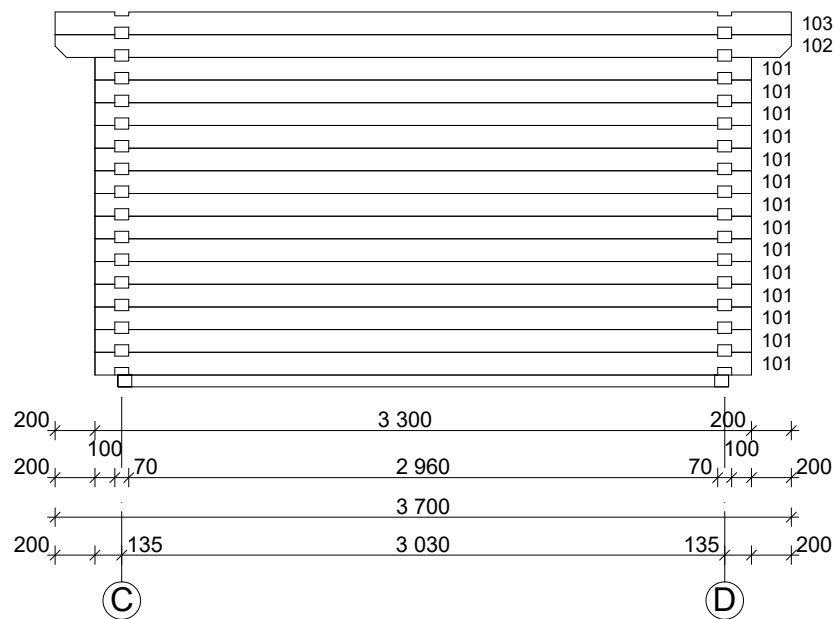
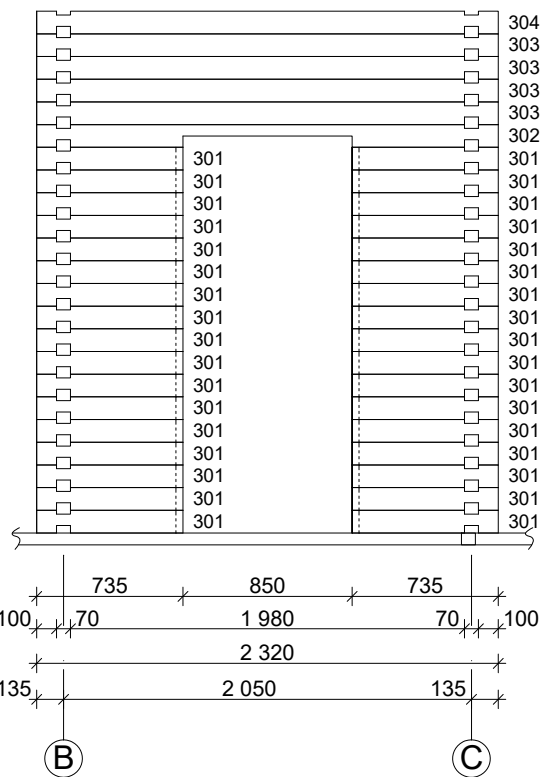

# Cervino 70 mm / 650 x 776 cm - 2

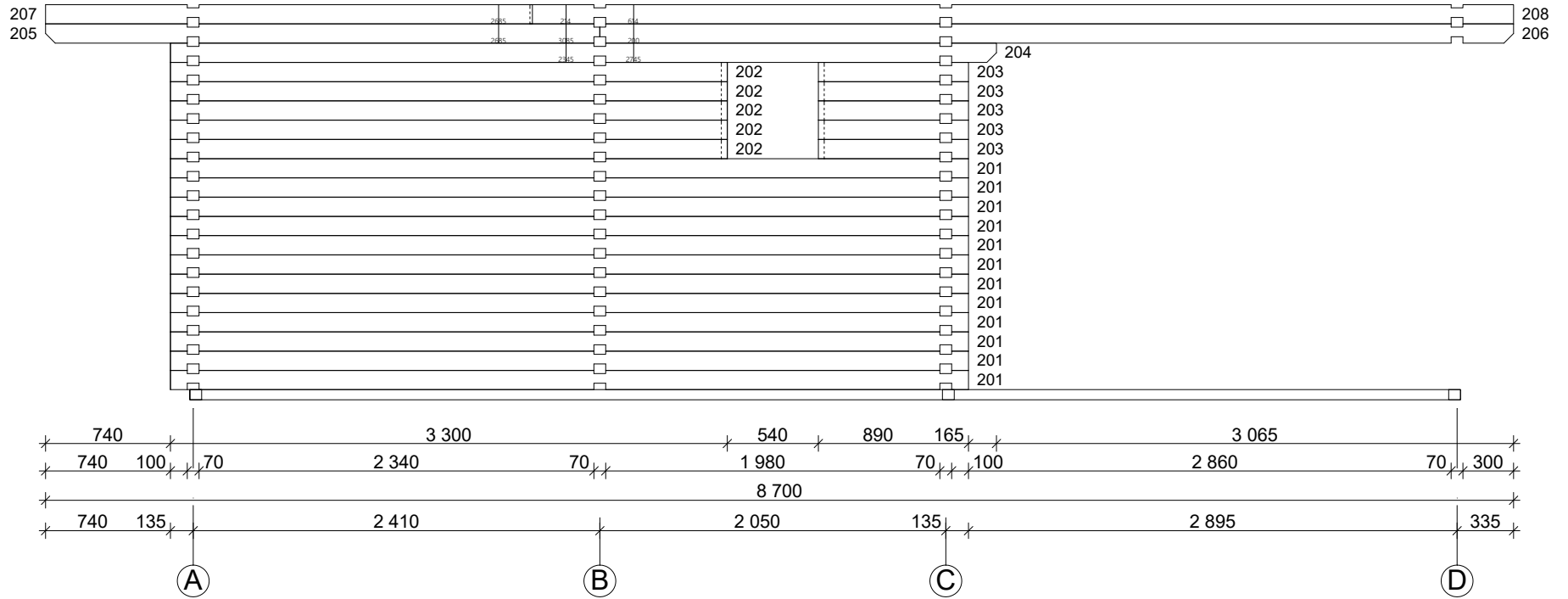

# Cervino 70 mm / 650 x 776 cm - 4

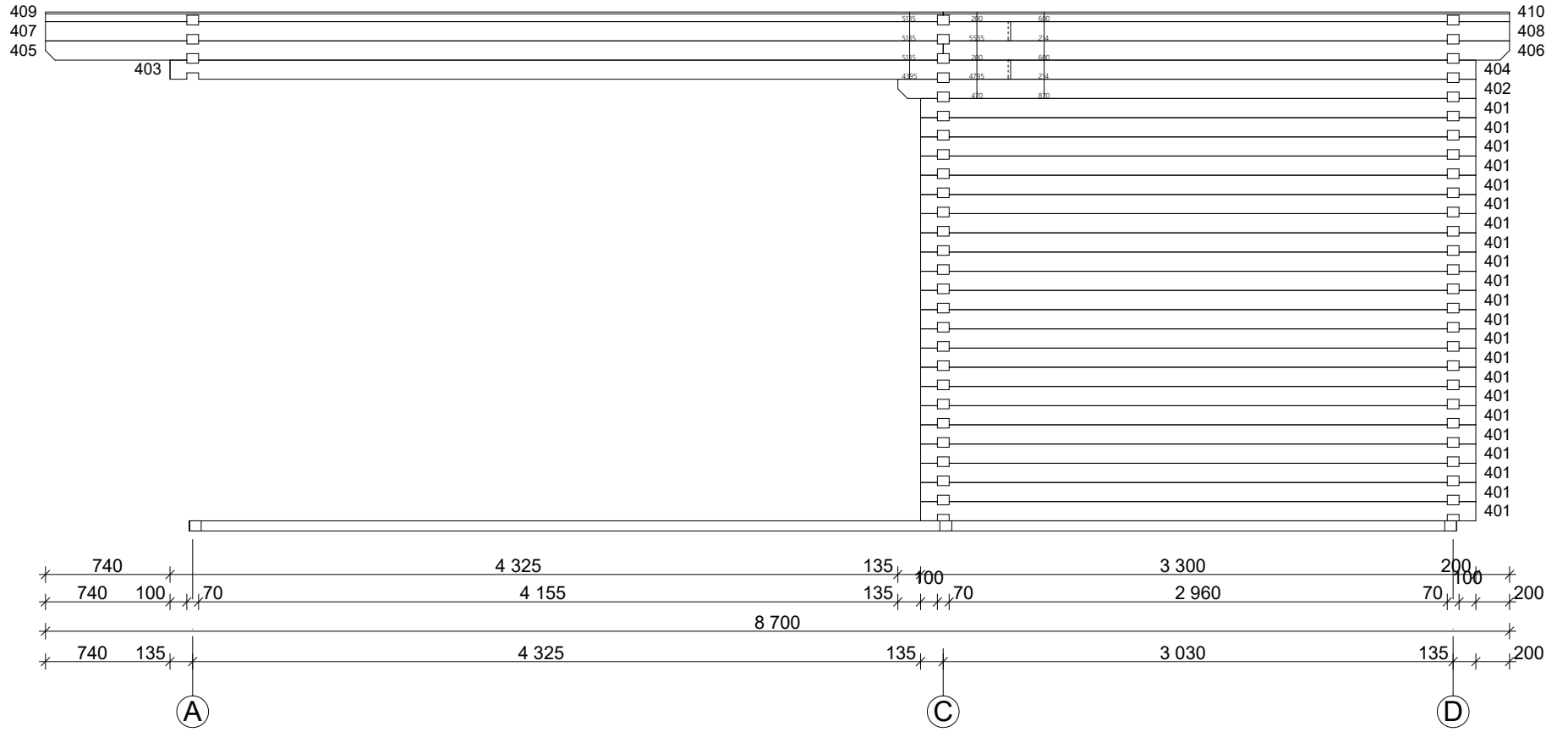

# Cervino 70 mm / 650 x 776 cm - 5

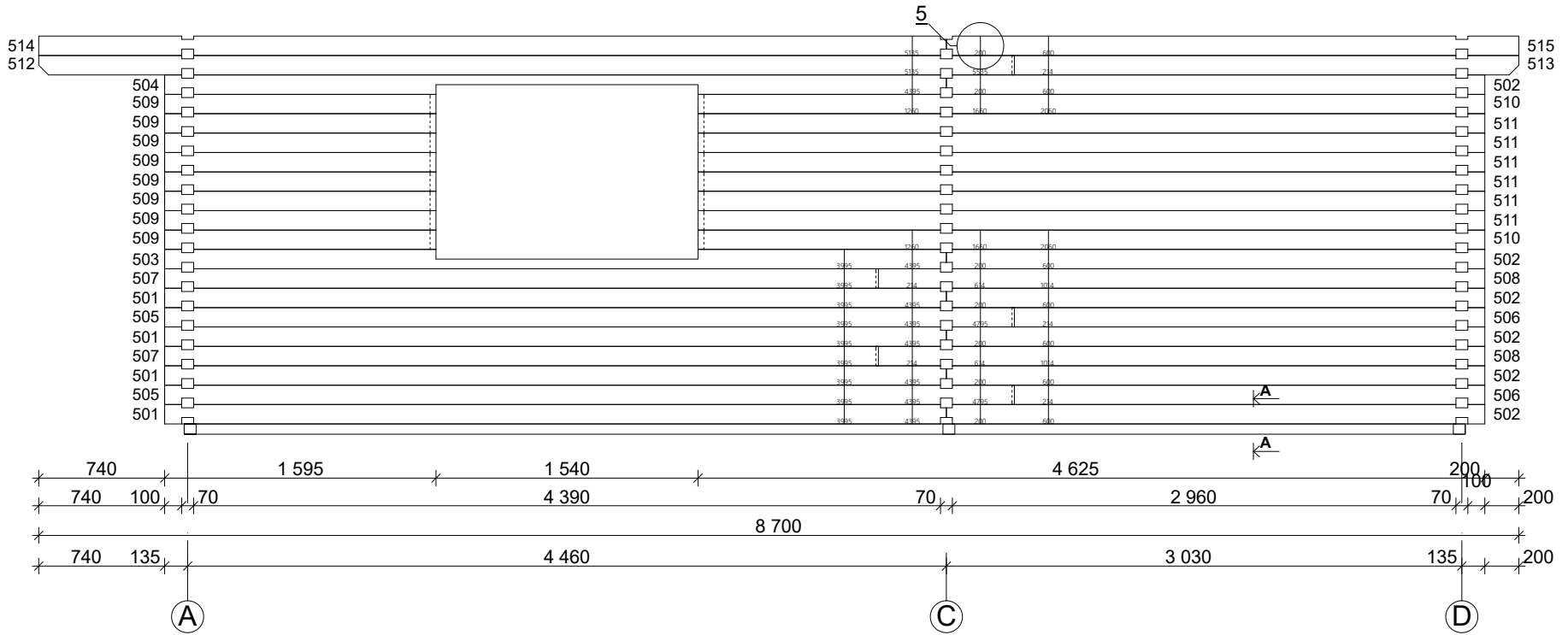
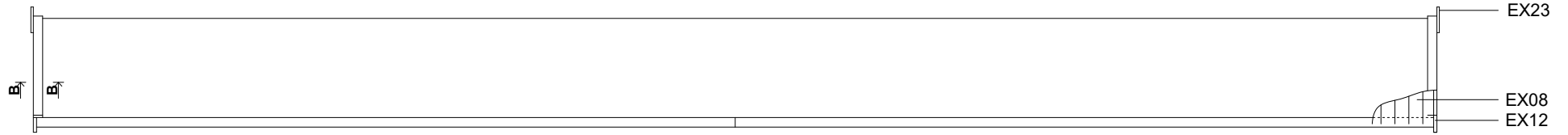

# Cervino 70 mm / 650 x 776 cm - LT

## LT-1

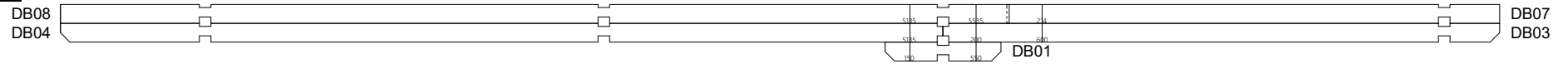



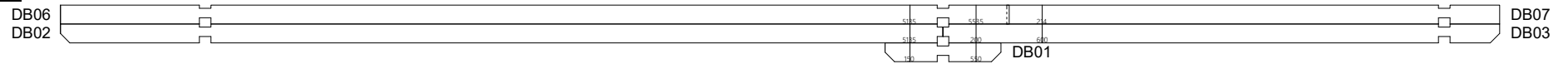



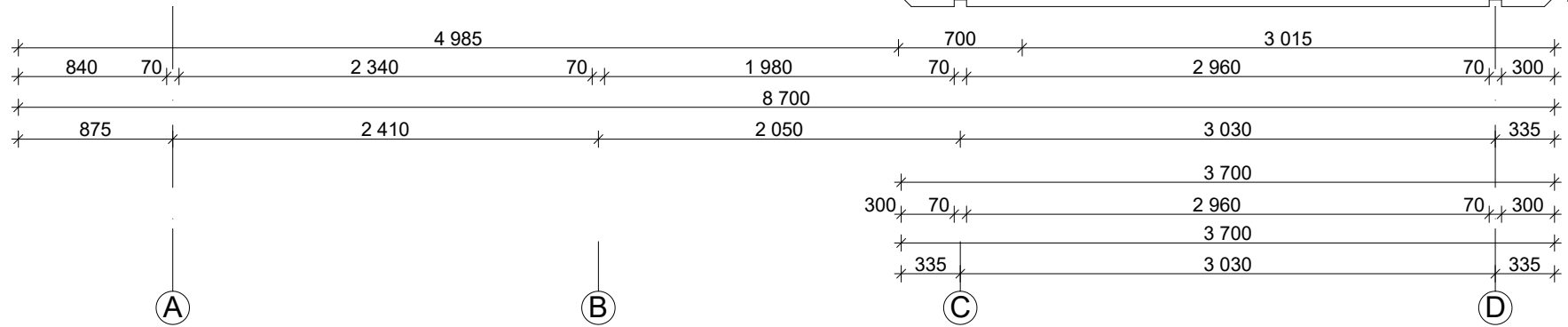
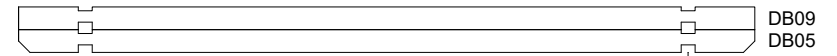

## LT-2

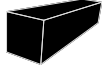

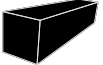
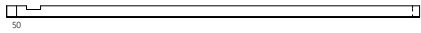
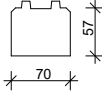
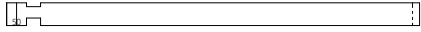
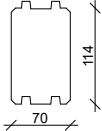
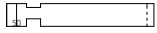
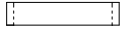
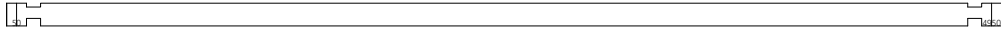

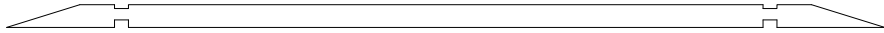
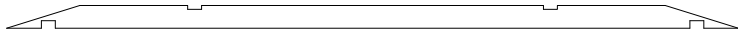



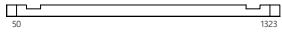
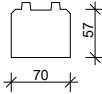
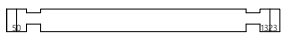
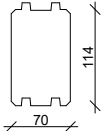
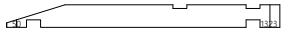





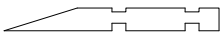
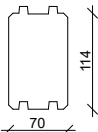
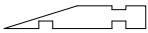

## LT-3

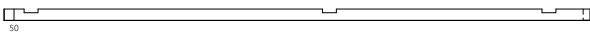

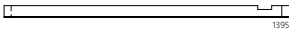
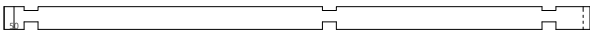
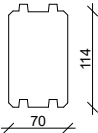

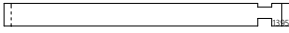
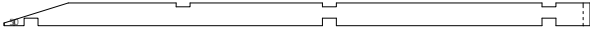
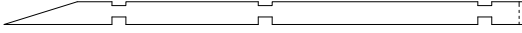



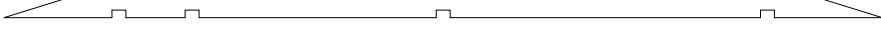
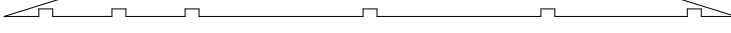
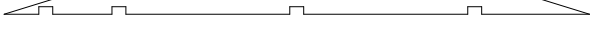







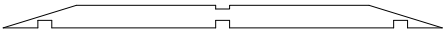
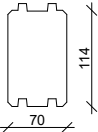

# Cervino 70 mm / 650 x 776 cm - A ; B

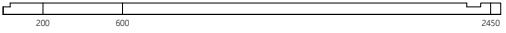
Nr.		 mm	 mm	 x
<b>A01</b>			2075	2
<b>A02</b>			2075	16
<b>A03</b>			740	18
<b>A04</b>			565	18
<b>A05</b>			5000	2
<b>A06</b>			5000	1
<b>A07</b>			4413	1
<b>A08</b>			3677	1
<b>A09</b>			2942	1
<b>A10</b>			2206	1
<b>A11</b>			1471	1
<b>A12</b>			735	1
<b>B01</b>				1373
<b>B02</b>			1373	19
<b>B03</b>			1373	1

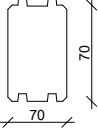
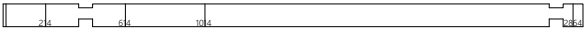
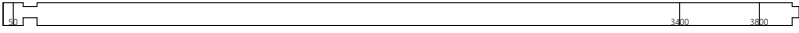
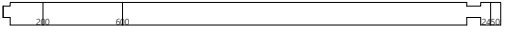
## Cervino 70 mm / 650 x 776 cm - B ; C



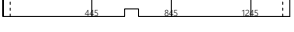
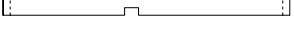

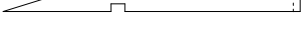



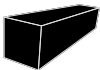

Nr.		 mm	 mm	 x
<b>B04</b>			1080	1
<b>B05</b>			712	1
<b>B06</b>			344	1
<b>C01</b>			2945	1
<b>C02</b>			410	1
<b>C03</b>			1445	1
<b>C04</b>			2945	15
<b>C05</b>			410	17
<b>C06</b>			1445	17
<b>C07</b>			2945	1
<b>C08</b>			2623	1
<b>C09</b>			5810	1
<b>C10</b>			5442	1
<b>C11</b>			5074	1
<b>C12</b>			4413	1
<b>C13</b>			3677	1
<b>C14</b>			2942	1

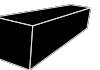
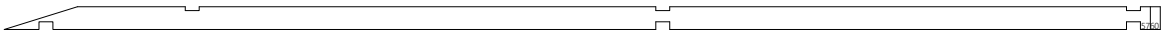
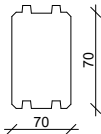
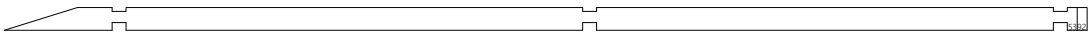
## Cervino 70 mm / 650 x 776 cm - C ; D





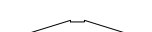
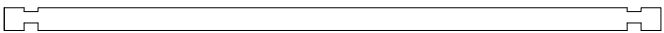
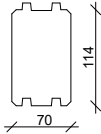

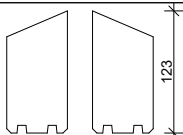
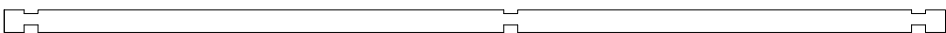
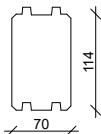
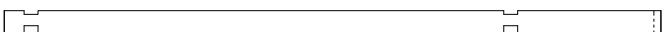
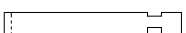



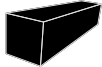

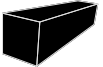

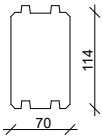
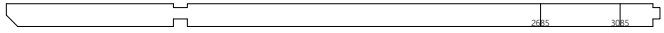
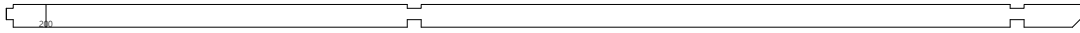
Nr.		 mm	 mm	 x
<b>C15</b>			2206	1
<b>C16</b>			1471	1
<b>C17</b>			735	1
<b>D01</b>			4000	1
<b>D02</b>			2500	1
<b>D03</b>			3600	2
<b>D04</b>			2900+14	2
<b>D05</b>			4000	4
<b>D06</b>			2500	4
<b>D07</b>			4400	2
<b>D08</b>			2100+14	2
<b>D09</b>			1815	7
<b>D10</b>			1440	1
<b>D11</b>			1440	8
<b>D12</b>			935	9
<b>D13</b>			1815	1
<b>D14</b>			1493	1

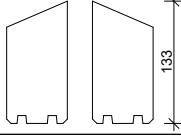

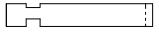
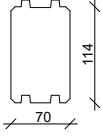

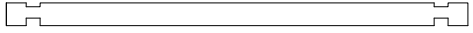
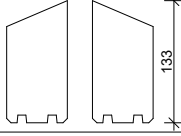
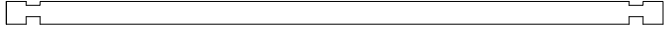
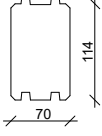
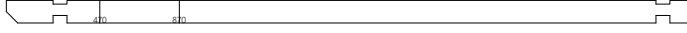

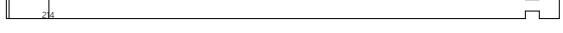
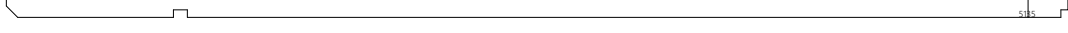





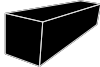

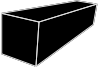

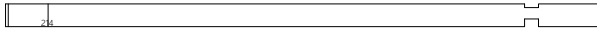

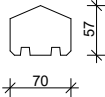
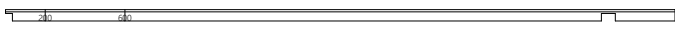

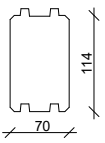
## Cervino 70 mm / 650 x 776 cm - D ; 1 ; 2

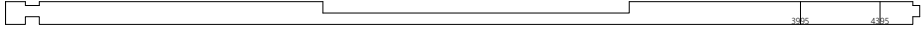
Nr.		 mm	 mm	 x
<b>D15</b>			5810	1
<b>D16</b>			5442	1
<b>D17</b>			5074	1
<b>D18</b>			4413	1
<b>D19</b>			3677	1
<b>D20</b>			2942	1
<b>D21</b>			2206	1
<b>D22</b>			1471	1
<b>D23</b>			735	1
<b>101</b>			3300	14
<b>102</b>			3700	1
<b>103</b>			3700	1(1+0)
<b>201</b>			4730	12
<b>202</b>			3300	5
<b>203</b>			809	5

## Cervino 70 mm / 650 x 776 cm - 2 ; 3 ; 4

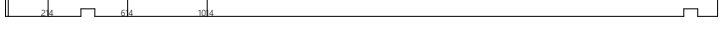
Nr.		 mm	 mm	 x
204			4895	1
205			3285	1
206			5415	1
207			2885	1(1+0)
208			5815+14	1(1+0)
301			735	34
302			2320	1
303			2320	5
304			2320	1(1+0)
401			3300	22
402			3435	1
403			4995	1
404			2765+14	1
405			5335	1
406			3365	1

# Cervino 70 mm / 650 x 776 cm - 4 ; 5

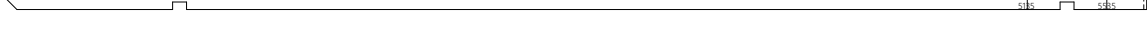
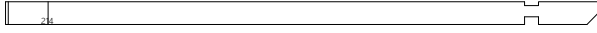
Nr.		 mm	 mm	 x
407			5735	1
408			2965+14	1
409			5335	1
410			3365	1
501			4595	4
502			3165	6
503			4595	1
504			4595	1
505			4995	2
506			2765+14	2
507			4195	2
508			3565+14	2
509			1595	8
510			4625	2
511			4625	6
512			5735	1
513			2965+14	1



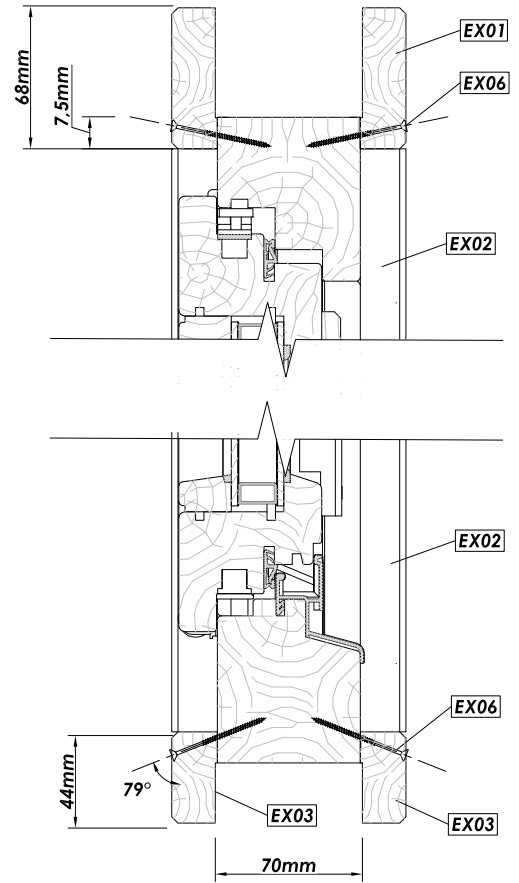
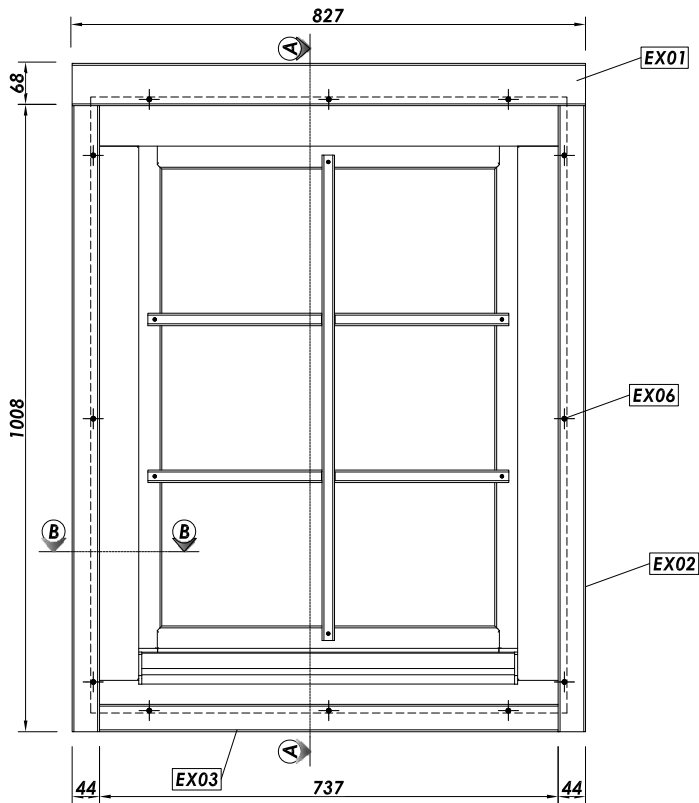

# A - A

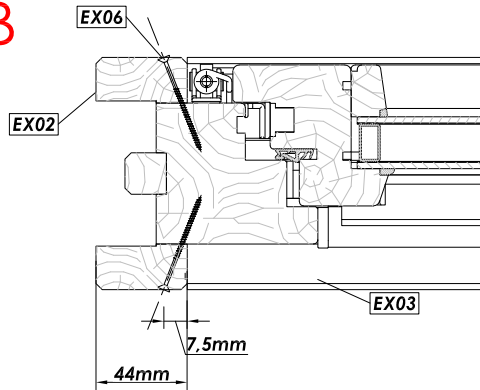

# B - B



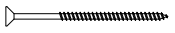

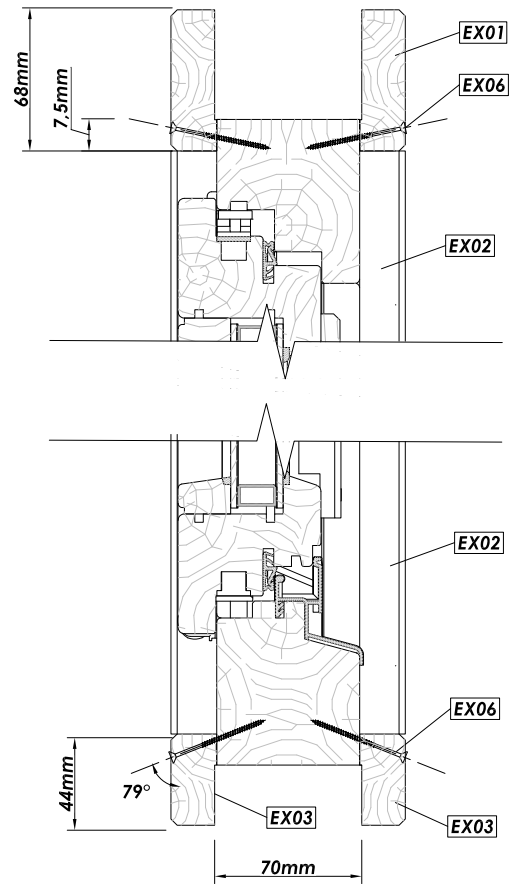
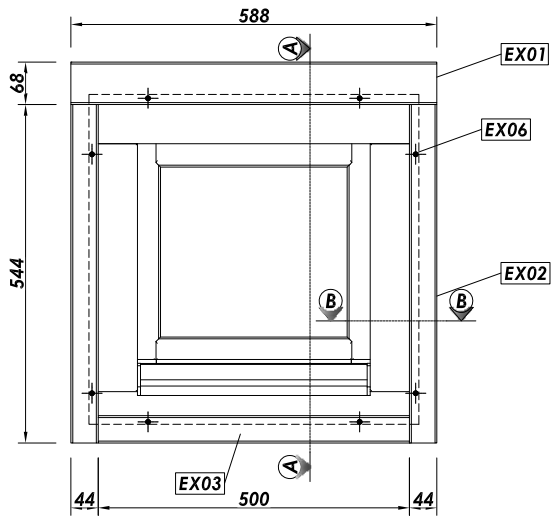

Premium Window 70mm / 765 x 990				
Nr.	Description	Profile mm	Length mm	Quantity
EX01	Exterior- and interior trim	 22x68	827	2
EX02	Exterior- and interior trim	 22x44	1008	4
EX03			737	2
EX04			--	--
EX05			--	--
EX06	Screws 3,5 x 50			

# A - A

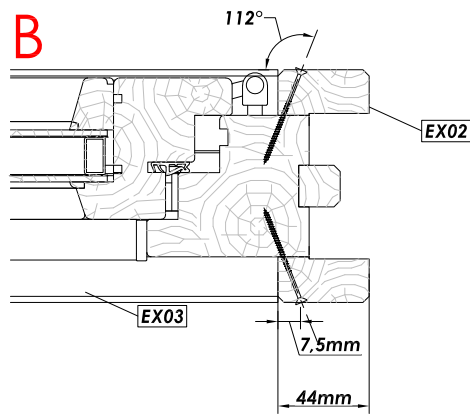

# B - B



Premium Window Sauna 70mm / 530 x 530				
Nr.	Description	Profile mm	Length mm	Quantity
EX01	Exterior- and interior trim	 22x68	588	2
EX02	Exterior- and interior trim	 22x44	544	4
EX03			500	2
EX04			--	--
EX05			--	--
EX06	Screws 3,5 x 50			

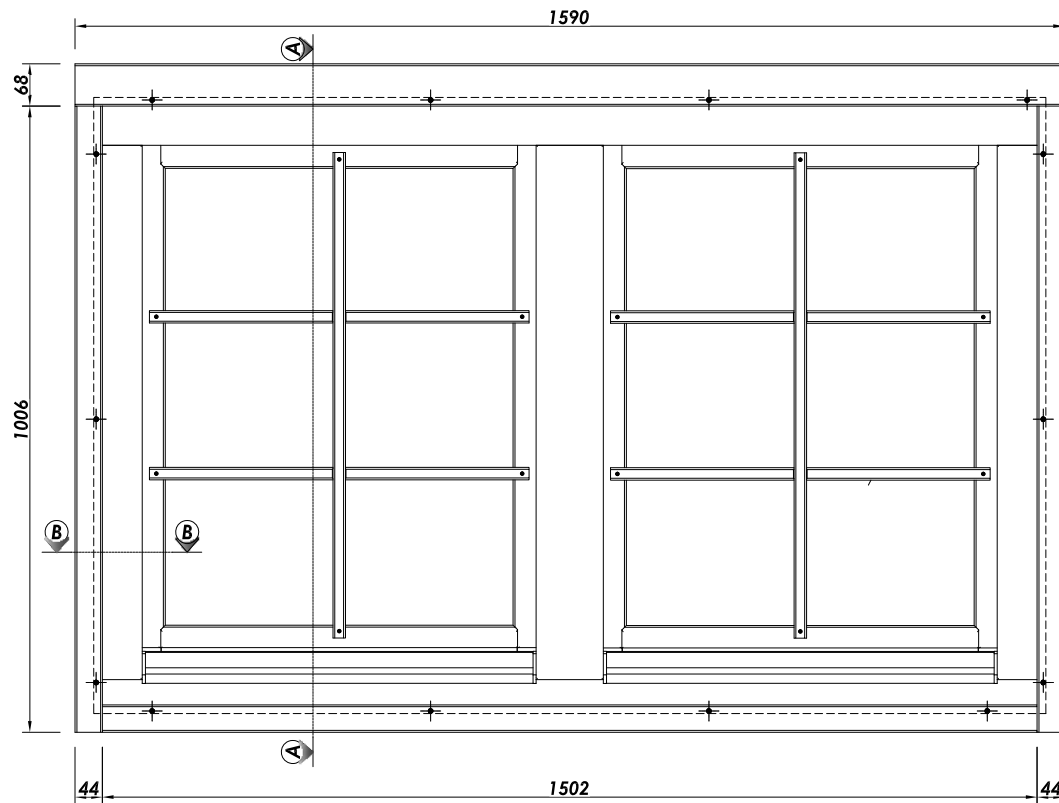

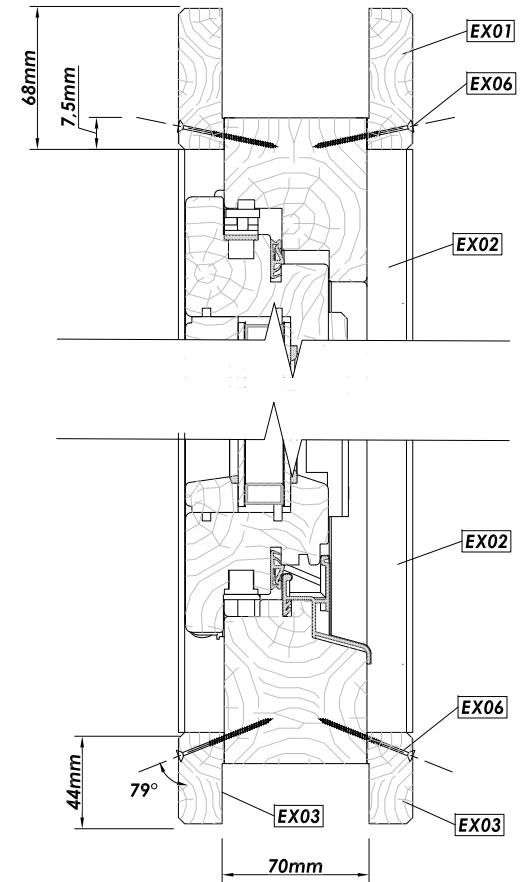

A - A

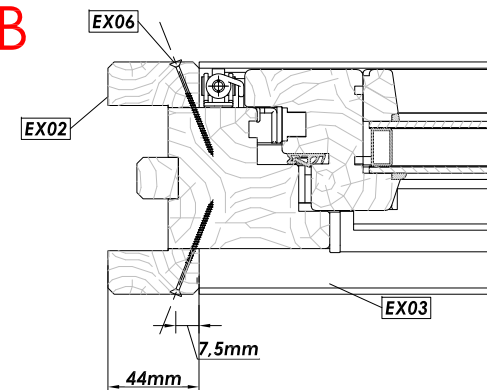

B - B



Premium Window 70mm / 1530 x 990

Nr.	Description	Profile mm	Length mm	Quantity
EX01	Exterior- and interior trim	 22x68	1590	2
EX02	Exterior- and interior trim	 22x44	1006	4
EX03			1502	2
EX04			--	--
EX05			--	--
EX06	Screws 3,5 x 50			28+2