

# Techn. Data Houston

Log length (W x D): 700 x 1 020 cm

Wall size(outside): 680 x 1 000 cm

Log thickness: 70 mm

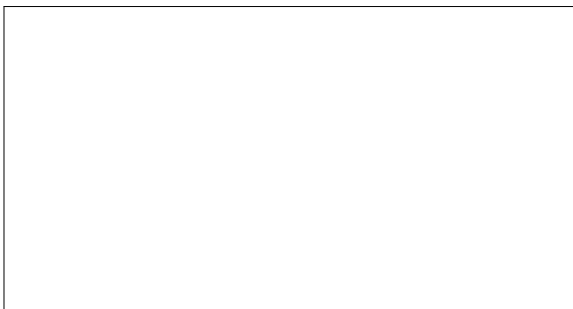
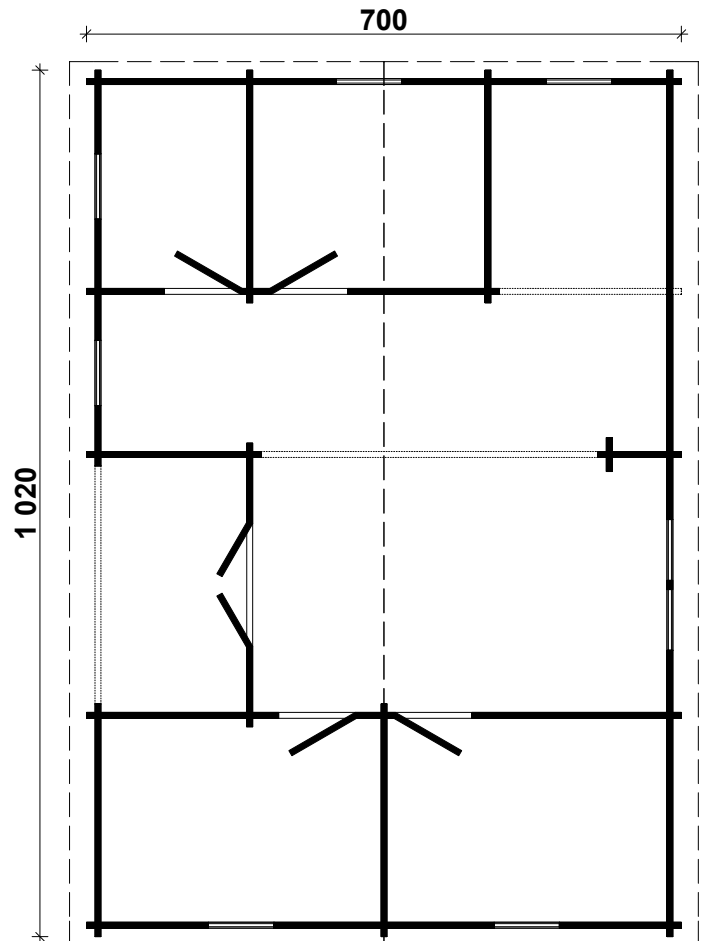
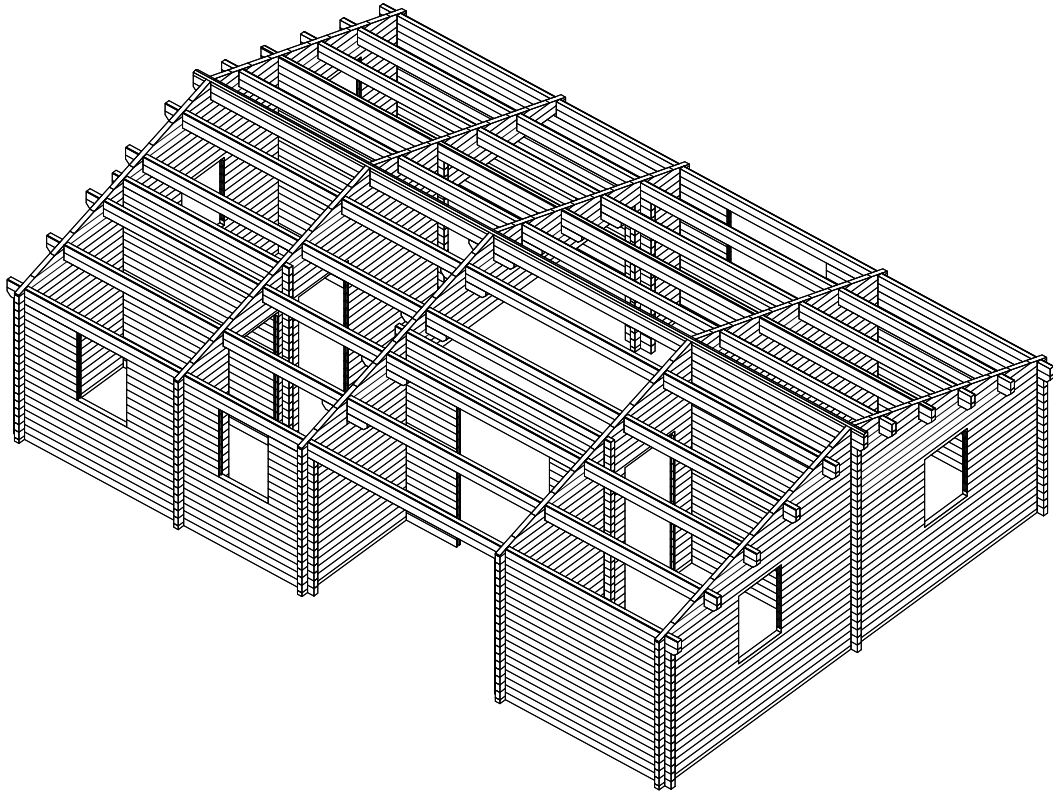

# Houston 70 mm / 700 x 1020 cm - Foundation

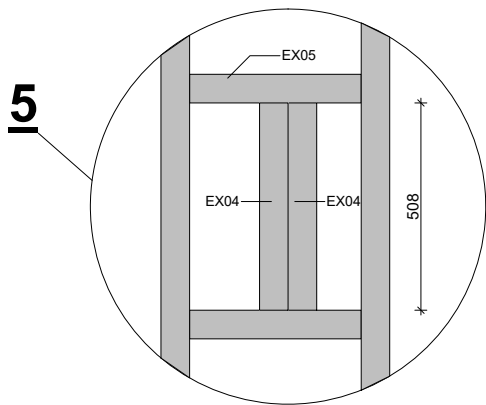
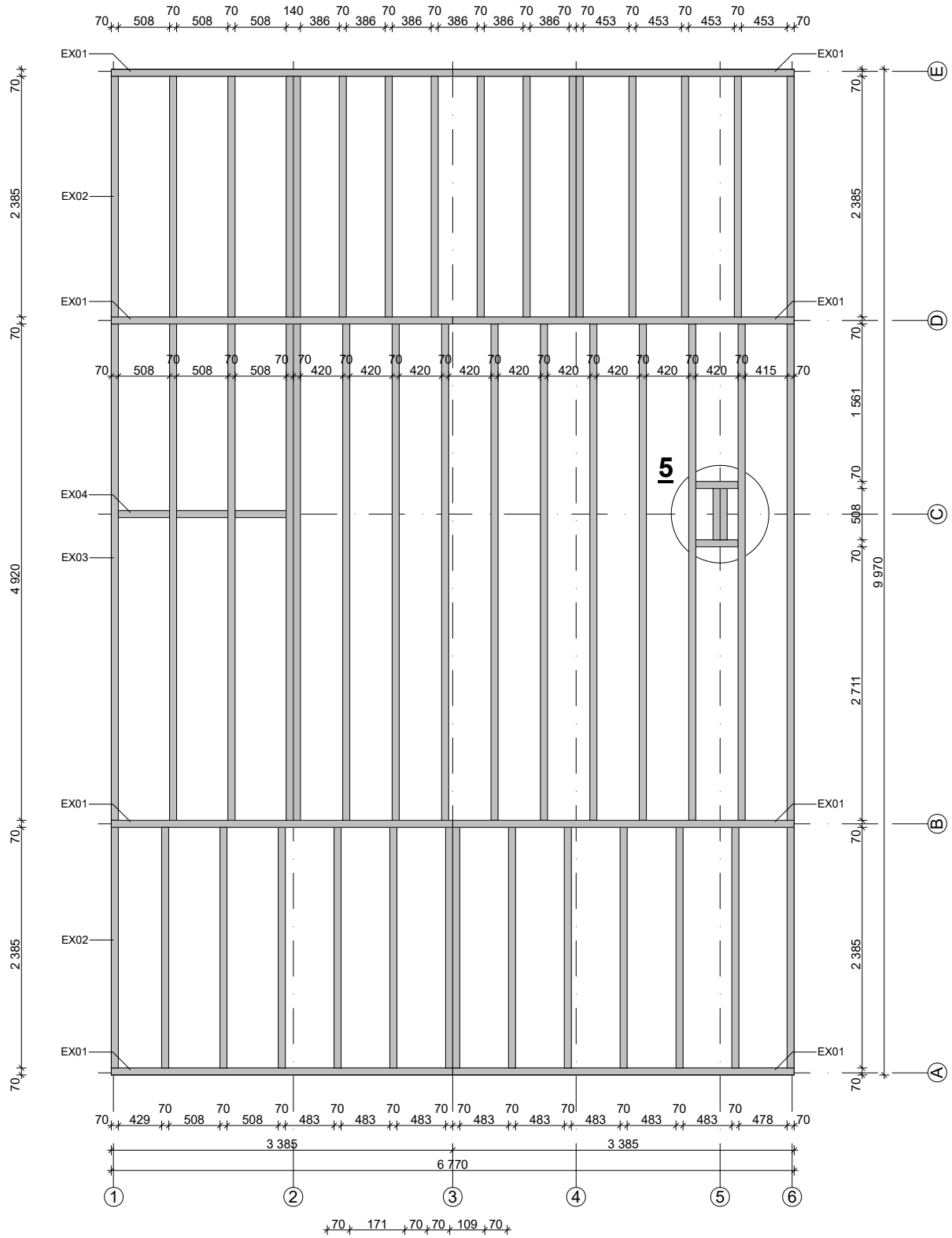

# Houston 70 mm / 700 x 1020 cm - Groundplan

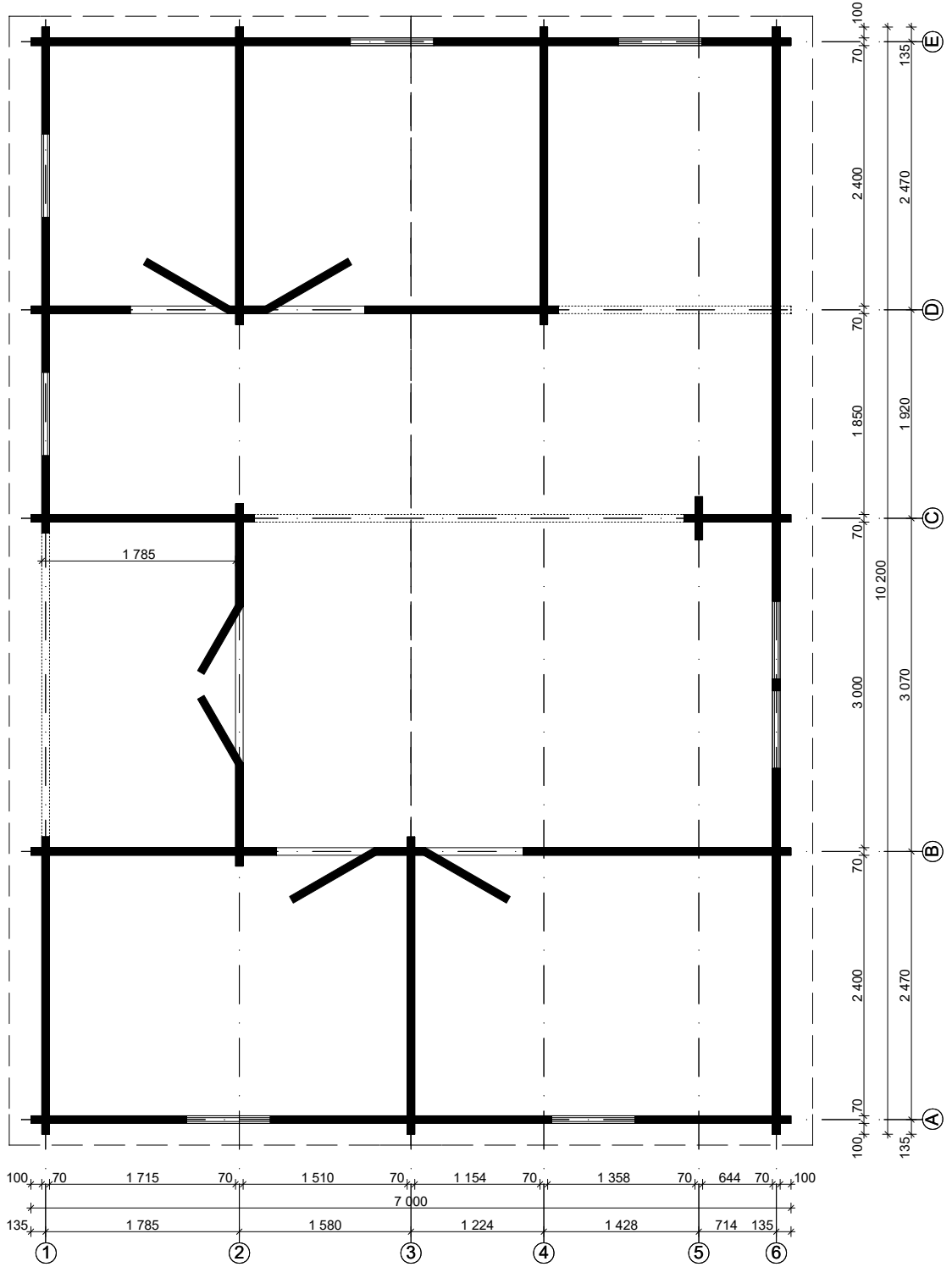



# Houston 70 mm / 700 x 1020 cm - A

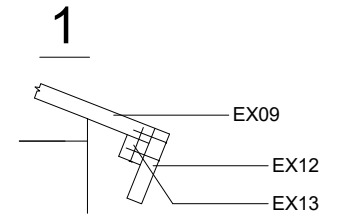
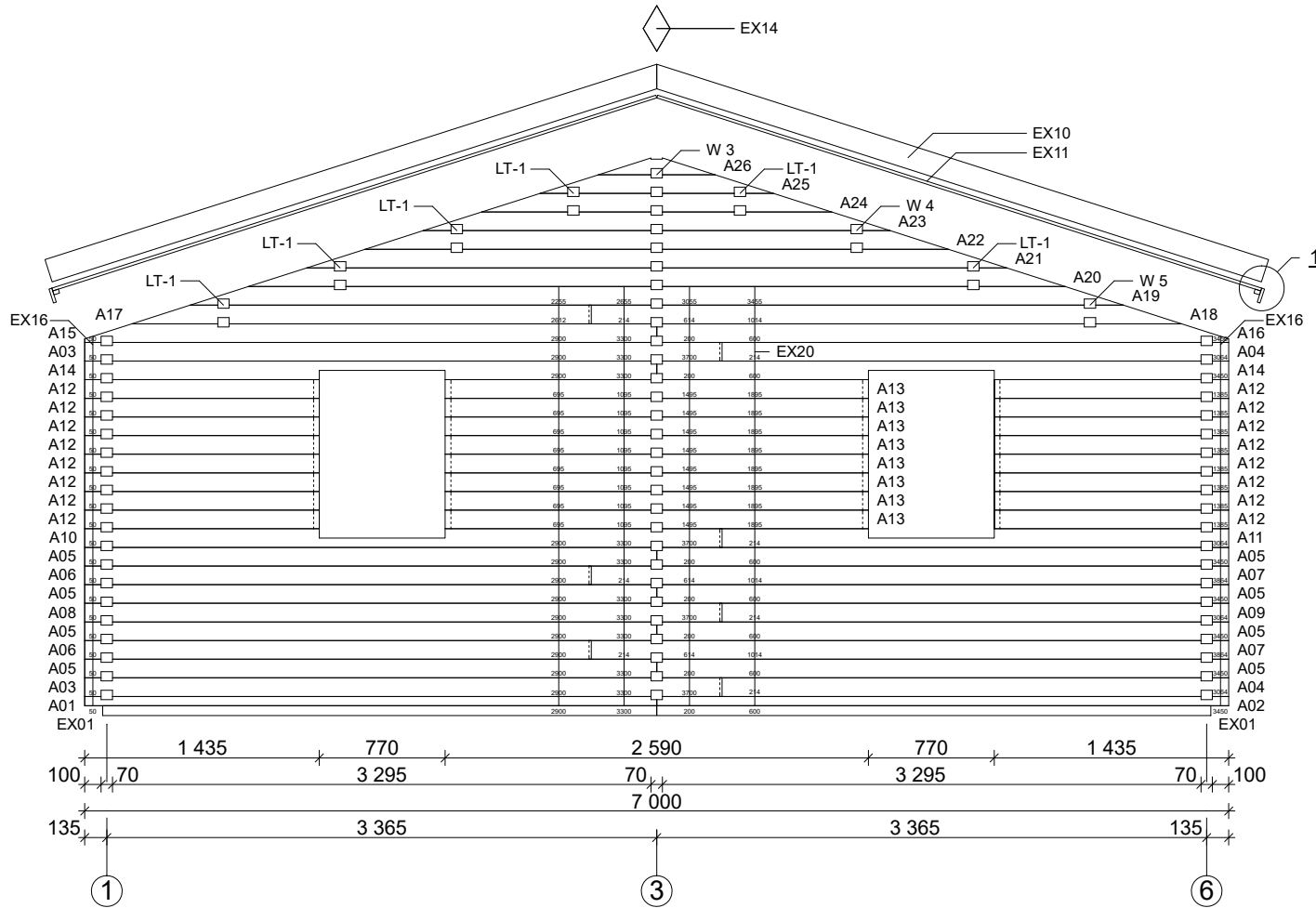

# Houston 70 mm / 700 x 1020 cm - B

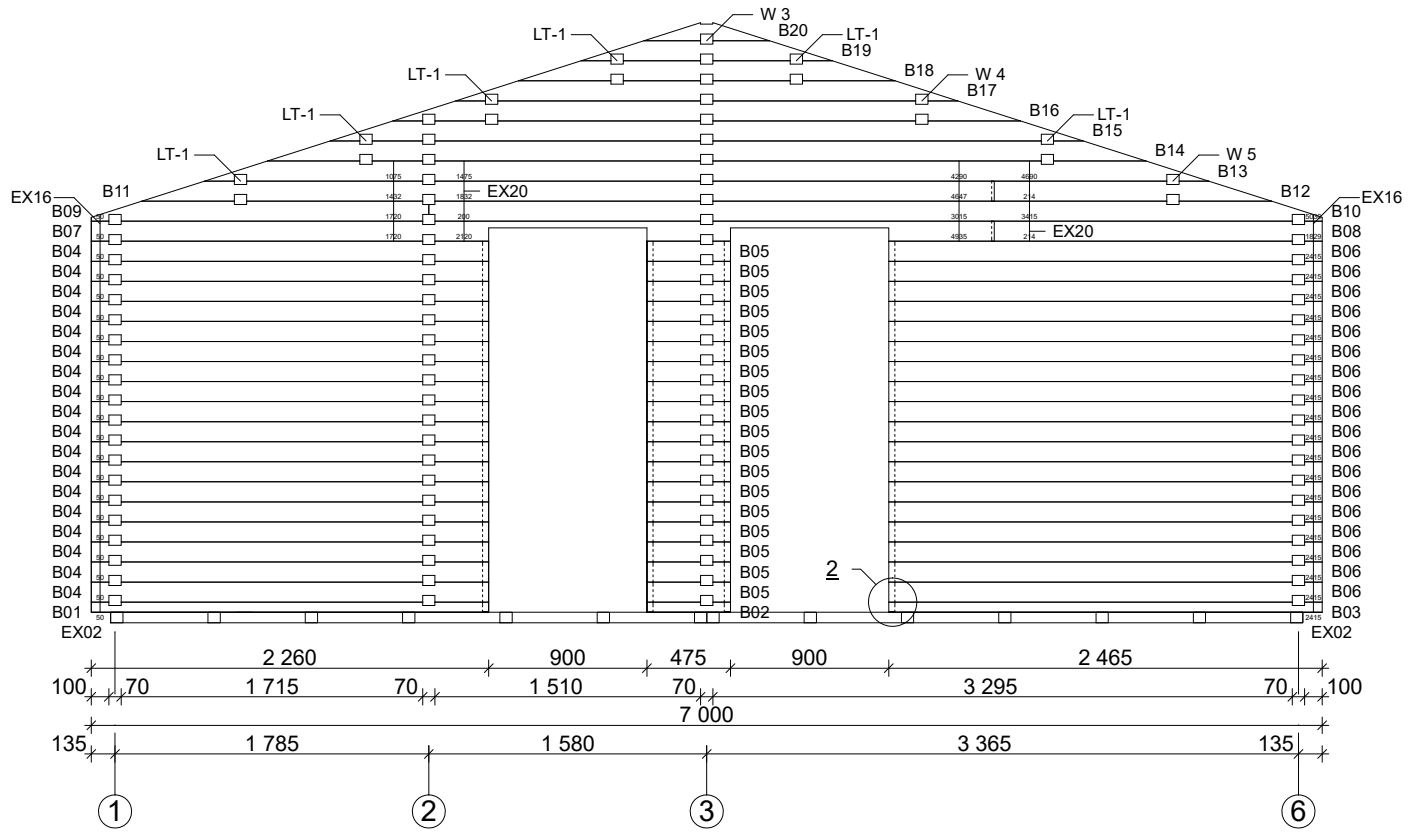

2

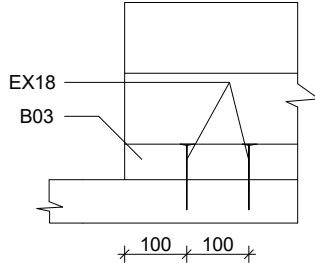

# Houston 70 mm / 700 x 1020 cm - C

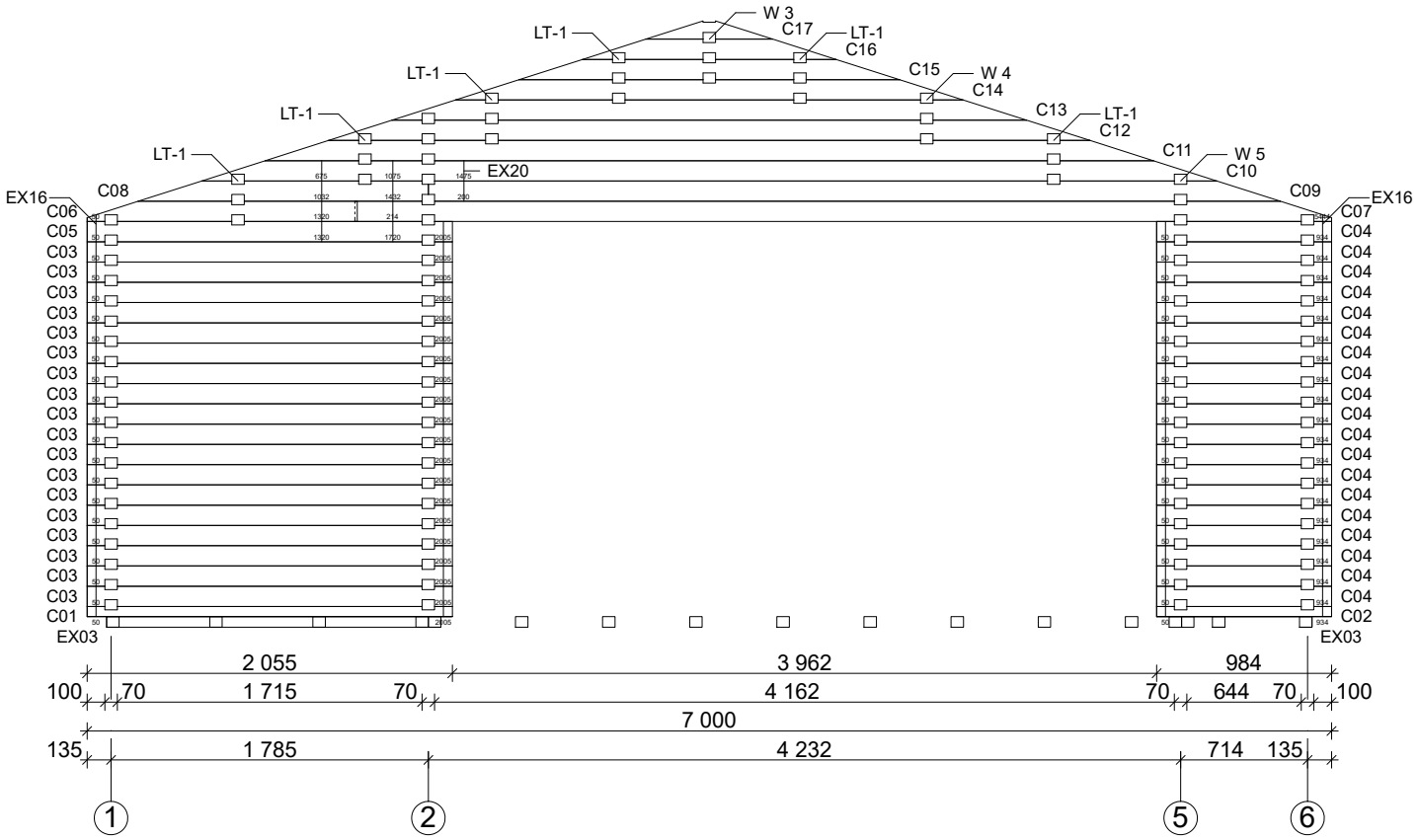

# Houston 70 mm / 700 x 1020 cm - D

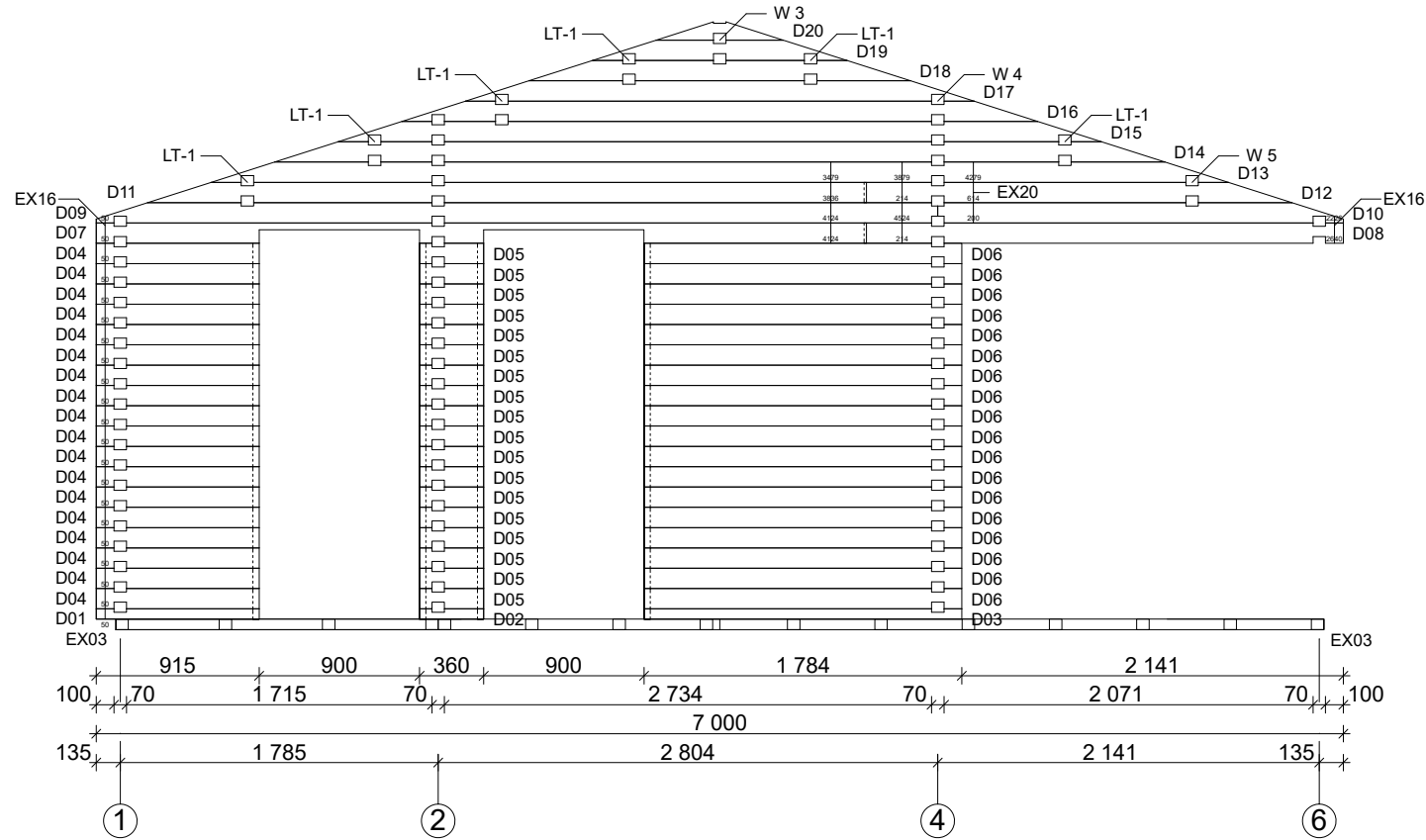

**4**

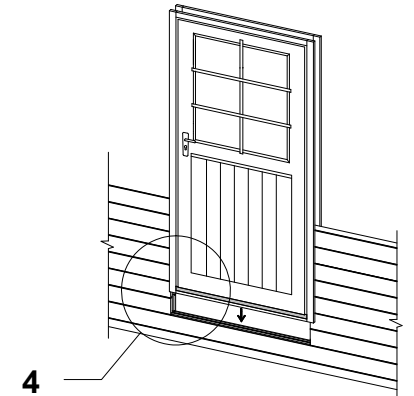
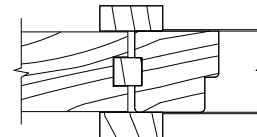



# Houston 70 mm / 700 x 1020 cm - E

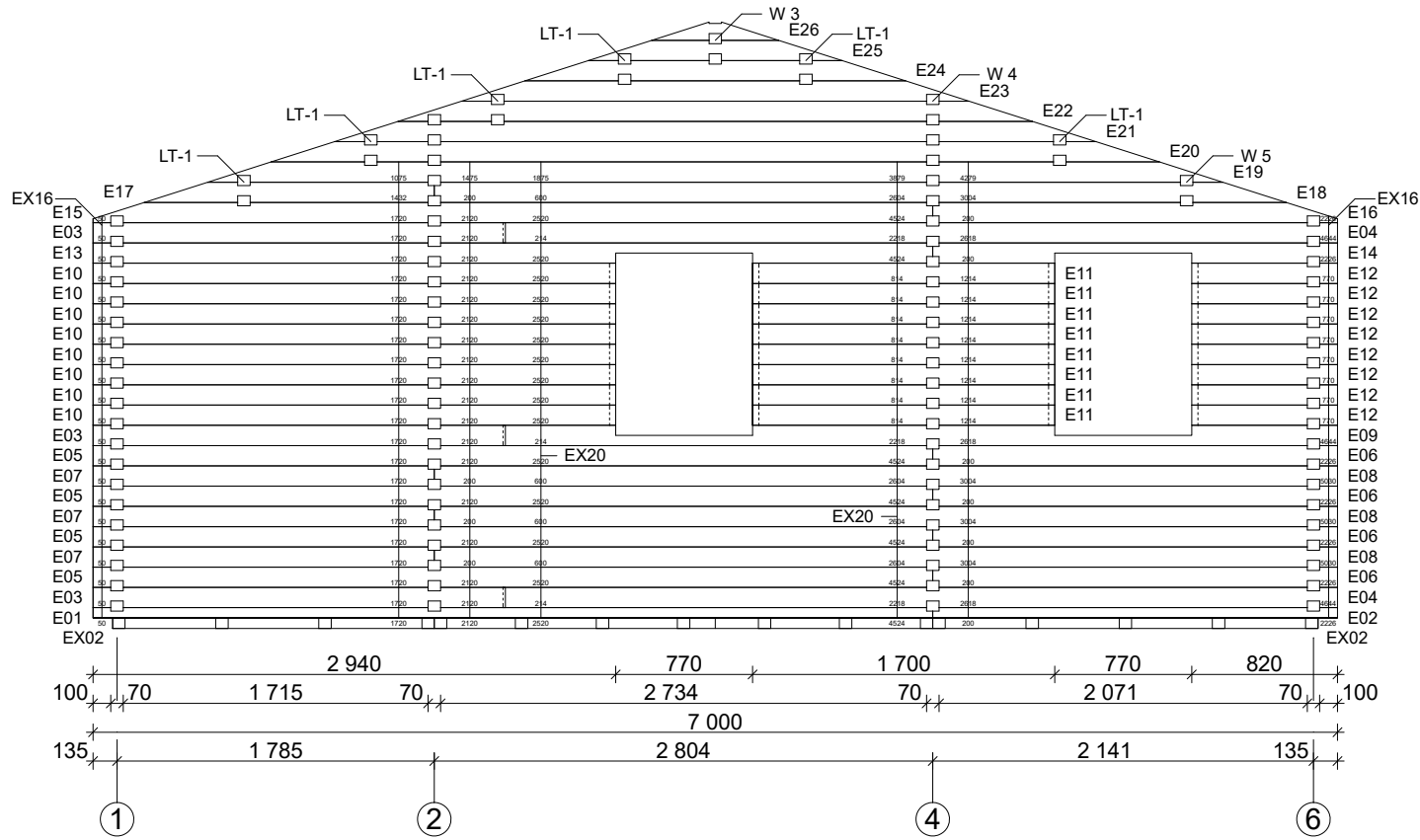

# Houston 70 mm / 700 x 1020 cm - 1; LT

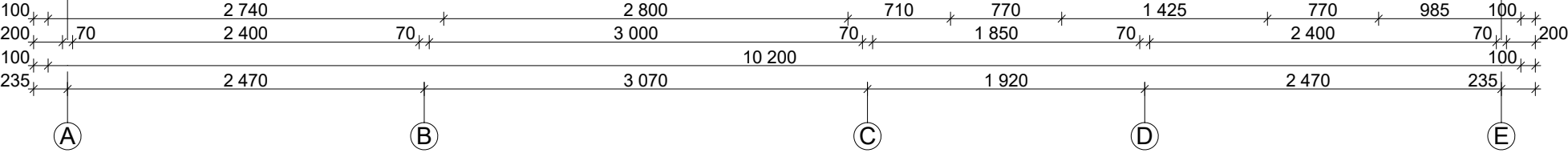
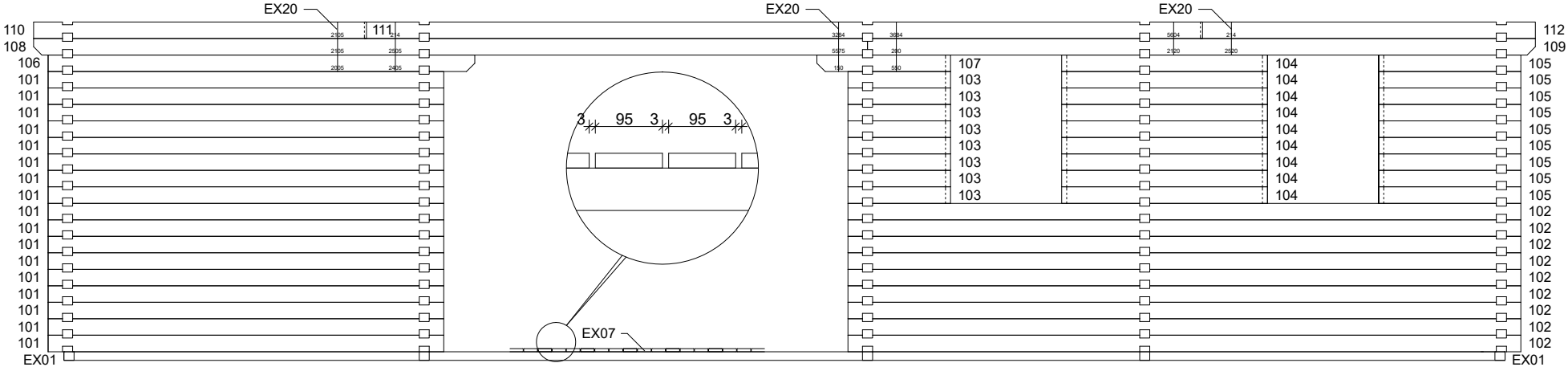

## LT -1

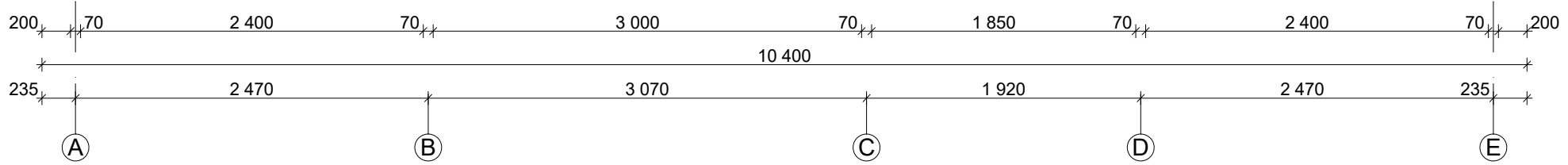
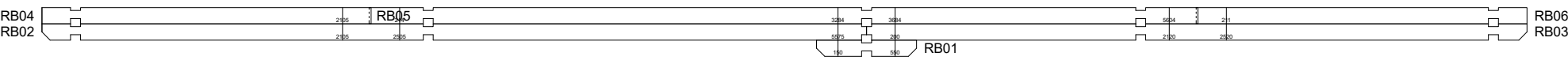

# Houston 70 mm / 700 x 1020 cm - 2

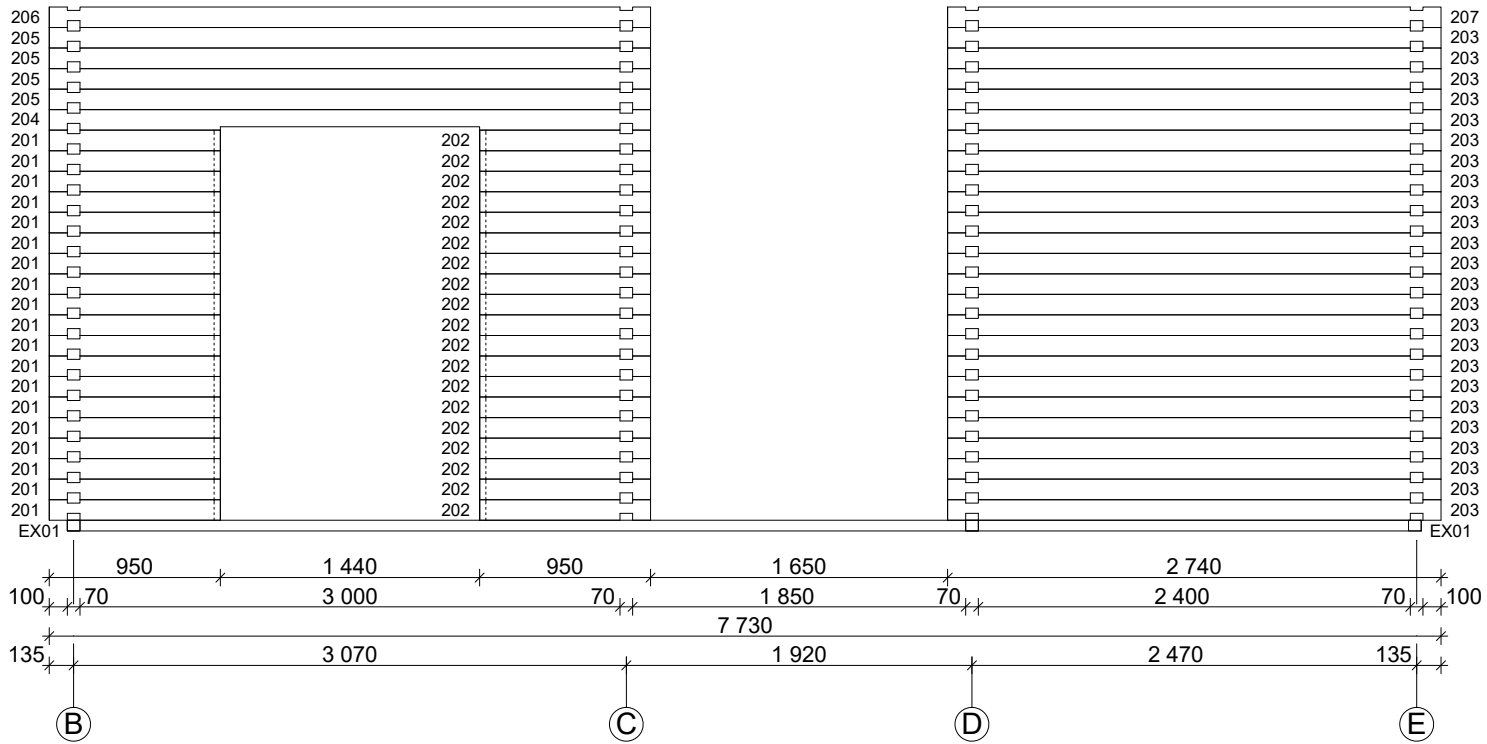

# Houston 70 mm / 700 x 1020 cm - 3

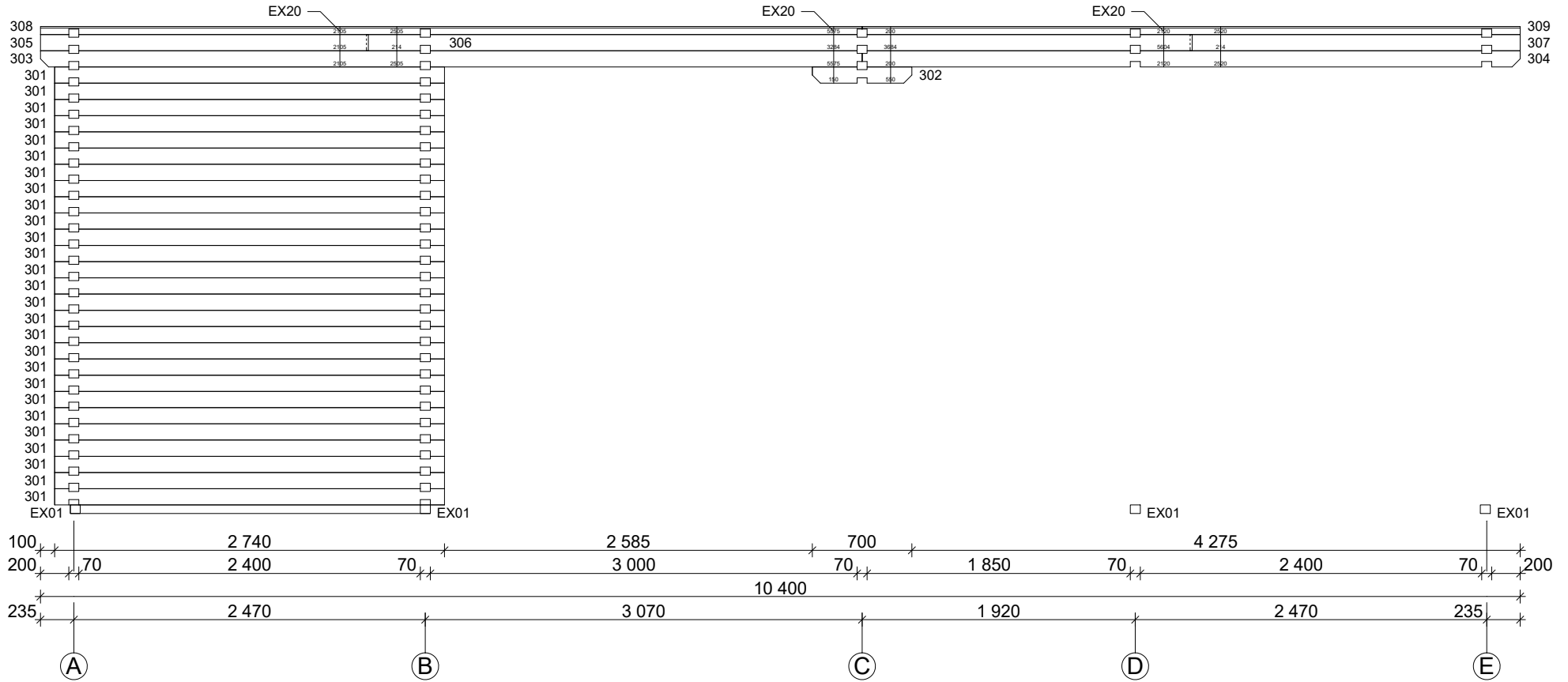

# Houston 70 mm / 700 x 1020 cm - 4

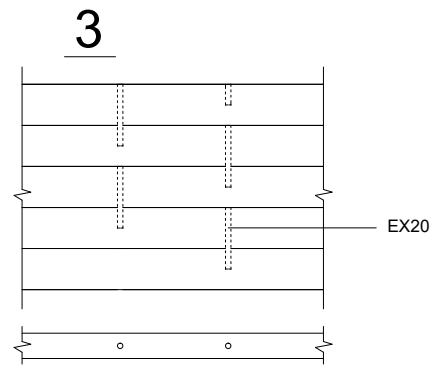
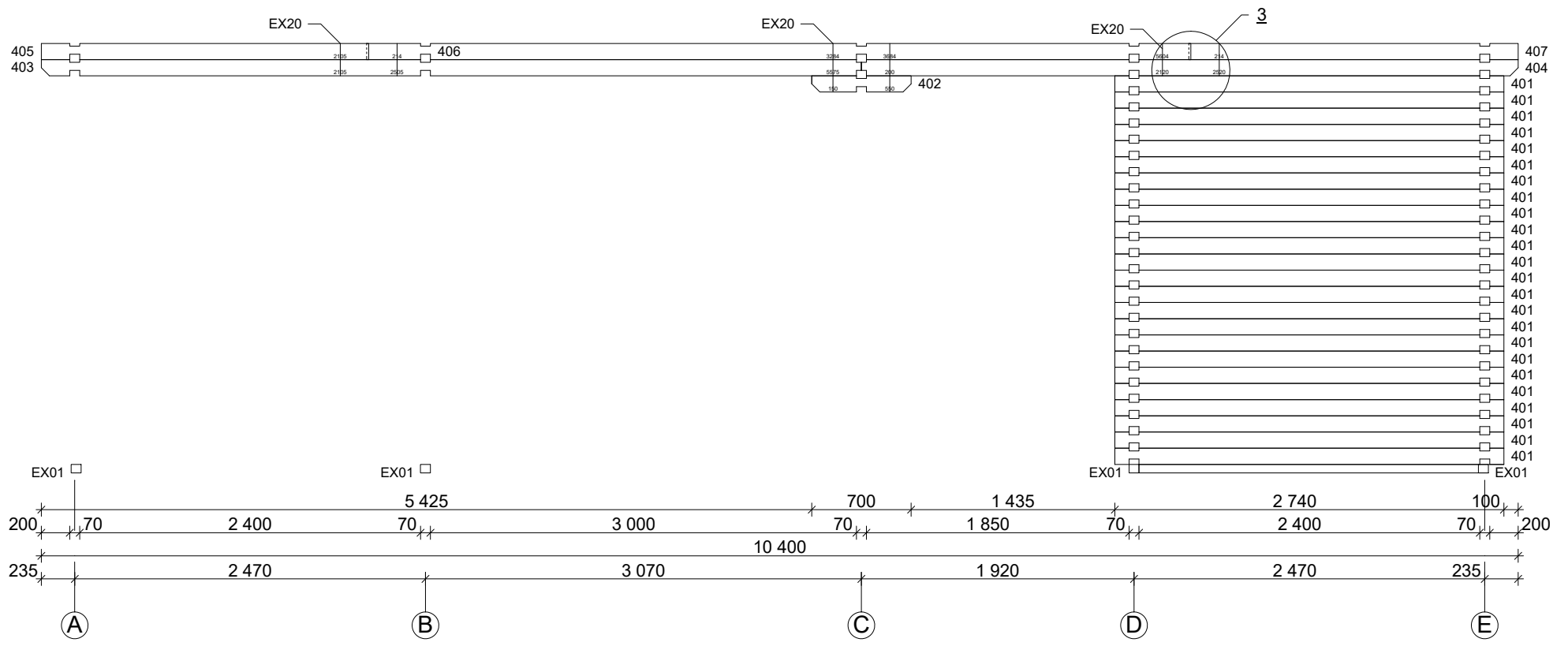

# Houston 70 mm / 700 x 1020 cm - 5

**A-A**

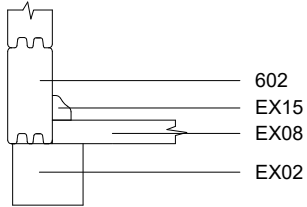



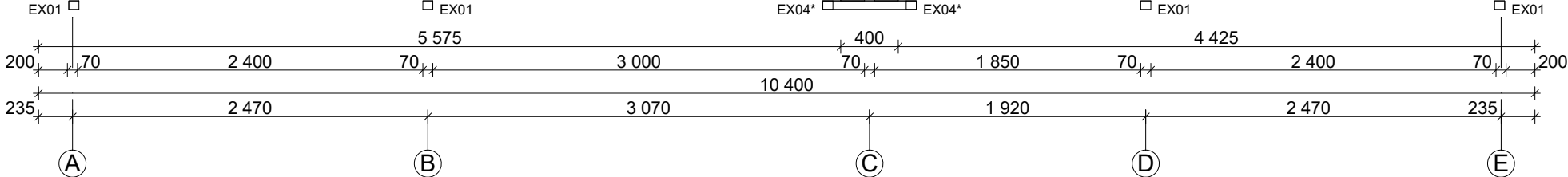
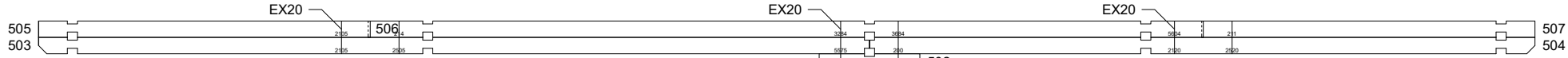
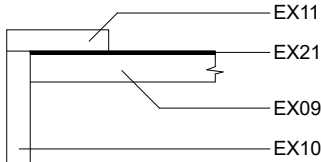



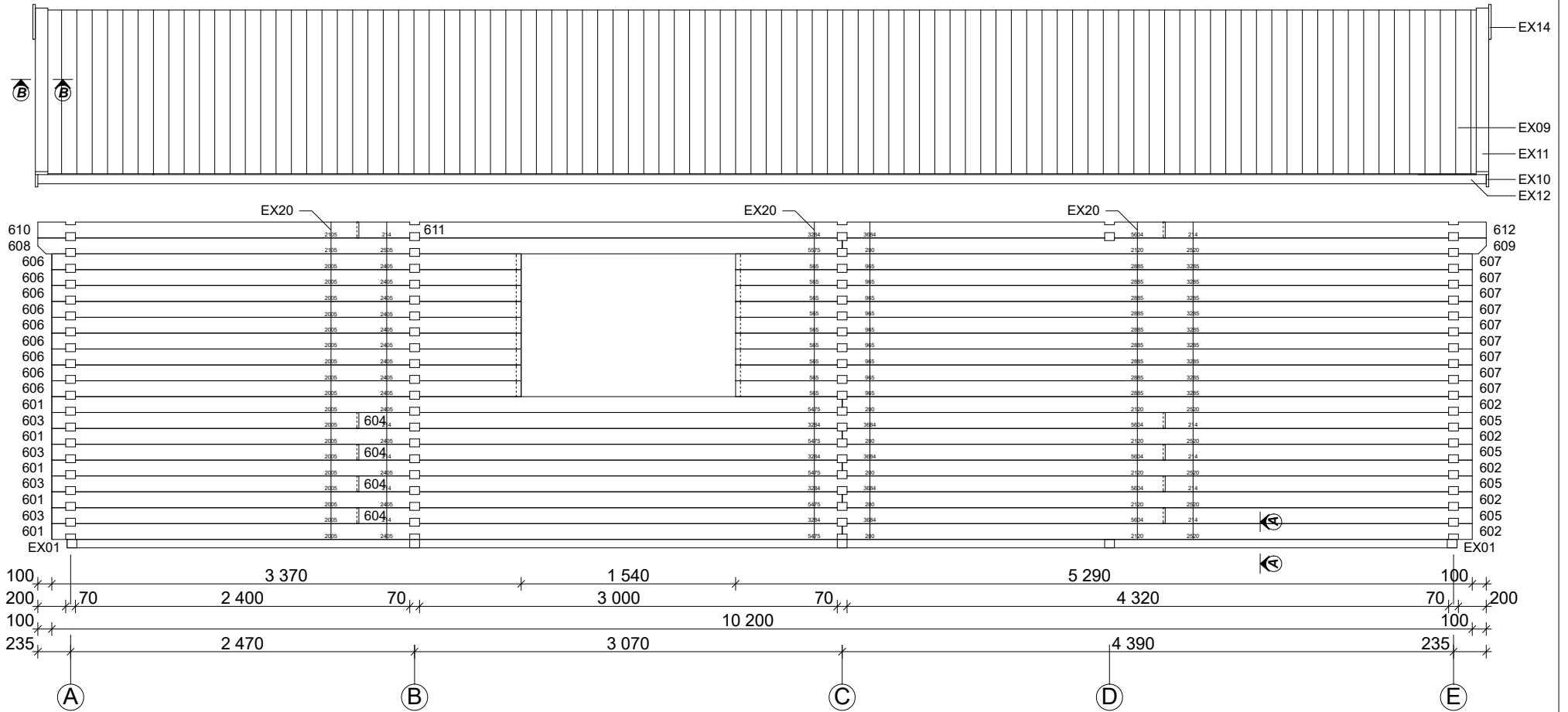



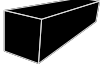

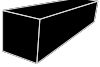
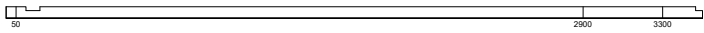
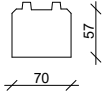
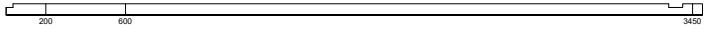
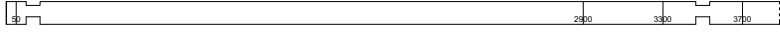
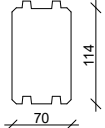



**B-B**

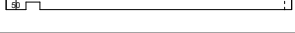

# Houston 70 mm / 700 x 1020 cm - 6



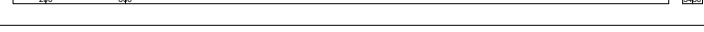
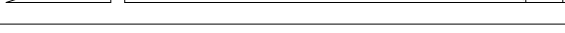











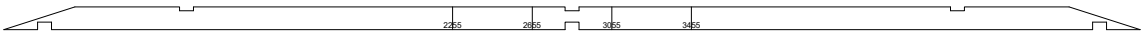
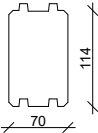

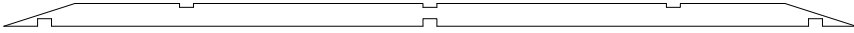

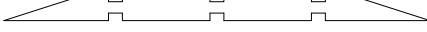
# Houston 70 mm / 700 x 1020 cm - A

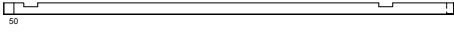
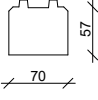
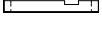
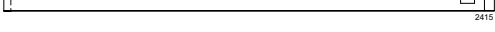

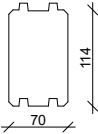
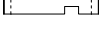









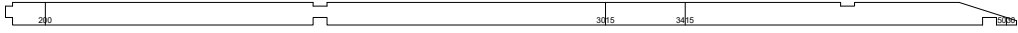
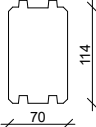

Nr.		 mm	 mm	 x
<b>A01</b>			3500	1
<b>A02</b>			3500	1
<b>A03</b>			3900	2
<b>A04</b>			3100+14	2
<b>A05</b>			3500	8
<b>A06</b>			3100	2
<b>A07</b>			3900+14	2
<b>A08</b>			3900	1
<b>A09</b>			3100+14	1
<b>A10</b>			3900	1
<b>A11</b>			3100+14	1
<b>A12</b>			1435	16
<b>A13</b>		2590	8	
<b>A14</b>		3500	2	
<b>A15</b>		3500	1	
<b>A16</b>		3500	1	
<b>A17</b>		2812	1	
<b>A18</b>		3612+14	1	



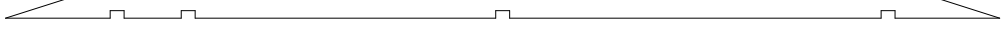
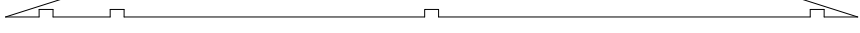
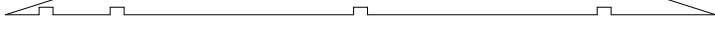
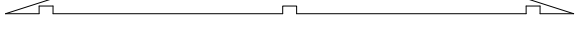
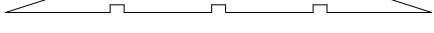

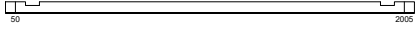

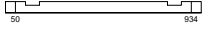
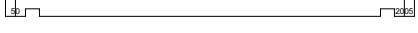
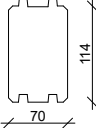

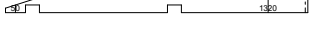



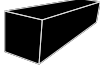

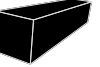
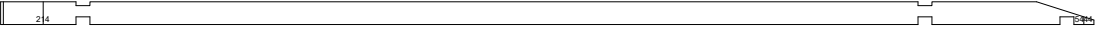
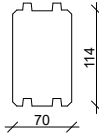
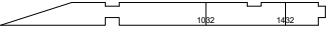

## Houston 70 mm / 700 x 1020 cm - A ; B

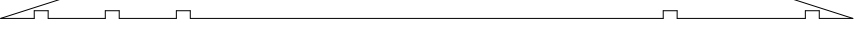
Nr.		 mm	 mm	 x
<b>A19</b>			5710	1
<b>A20</b>			4997	1
<b>A21</b>			4283	1
<b>A22</b>			3569	1
<b>A23</b>			2855	1
<b>A24</b>			2141	1
<b>A25</b>			1428	1
<b>A26</b>			714	1
<b>B01</b>			2260	1
<b>B02</b>			475	1
<b>B03</b>			2465	1
<b>B04</b>			2260	18
<b>B05</b>			475	18
<b>B06</b>			2465	18
<b>B07</b>			5135	1
<b>B08</b>			1865+14	1
<b>B09</b>		1920	1	

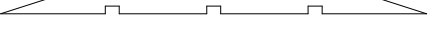
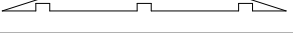

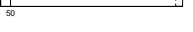

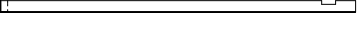
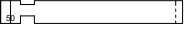
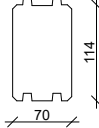







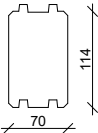
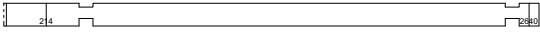
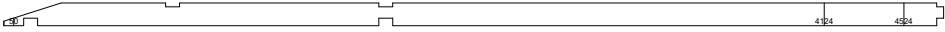
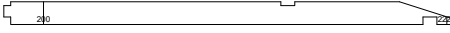

# Houston 70 mm / 700 x 1020 cm - B ; C

Nr.		 mm	 mm	 x	
<b>B10</b>			5080	1	
<b>B11</b>			4847	1	
<b>B12</b>			1577+14	1	
<b>B13</b>			5710	1	
<b>B14</b>			4997	1	
<b>B15</b>			4283	1	
<b>B16</b>			3569	1	
<b>B17</b>			2855	1	
<b>B18</b>			2141	1	
<b>B19</b>			1428	1	
<b>B20</b>			714	1	
<b>C01</b>				2055	1
<b>C02</b>				984	1
<b>C03</b>				2055	18
<b>C04</b>				984	19
<b>C05</b>				2055	1
<b>C06</b>				1520	1

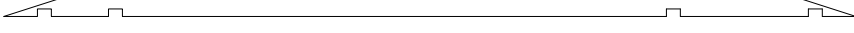



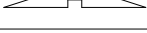
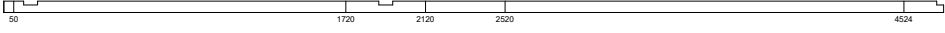

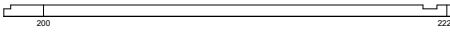
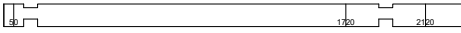
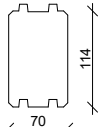



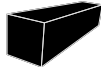

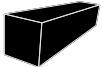

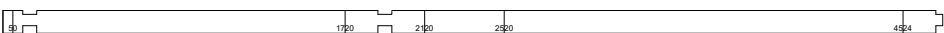

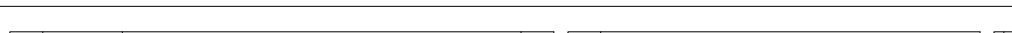
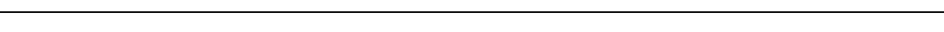
# Houston 70 mm / 700 x 1020 cm - C ; D

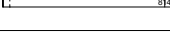
Nr.		 mm	 mm	 x	
<b>C07</b>			5480+14	1	
<b>C08</b>			1632	1	
<b>C09</b>			4793	1	
<b>C10</b>			3565	1	
<b>C11</b>			2509	1	
<b>C12</b>			3565	1	
<b>C13</b>			1877	1	
<b>C14</b>			4482	1	
<b>C15</b>			2509	1	
<b>C16</b>			3565	1	
<b>C17</b>			1877	1	
<b>D01</b>				915	1
<b>D02</b>				360	1
<b>D03</b>				1784	1
<b>D04</b>				915	18
<b>D05</b>				360	18
<b>D06</b>		1784		18	

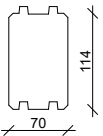
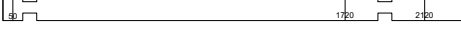

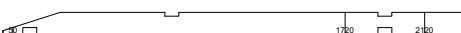

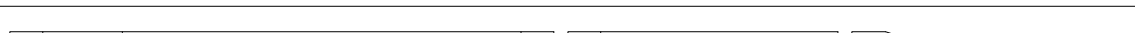
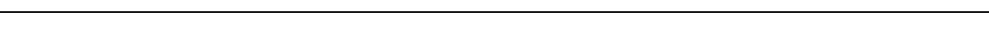









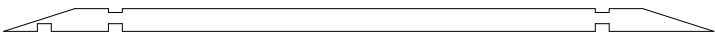
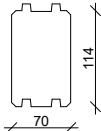
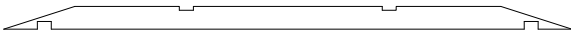

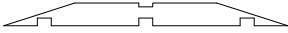
# Houston 70 mm / 700 x 1020 cm - D ; E

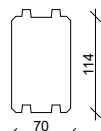
Nr.		 mm	 mm	 ×	
<b>D07</b>			4324	1	
<b>D08</b>			2676+14	1	
<b>D09</b>			4724	1	
<b>D10</b>			2276	1	
<b>D11</b>			4036	1	
<b>D12</b>			2389+14	1	
<b>D13</b>			5710	1	
<b>D14</b>			4997	1	
<b>D15</b>			4283	1	
<b>D16</b>			3569	1	
<b>D17</b>			2855	1	
<b>D18</b>			2141	1	
<b>D19</b>			1428	1	
<b>D20</b>			714	1	
<b>E01</b>				4724	1
<b>E02</b>				2276	1
<b>E03</b>				2320	3

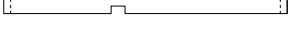
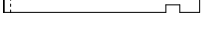

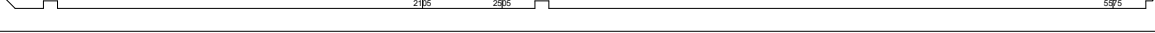
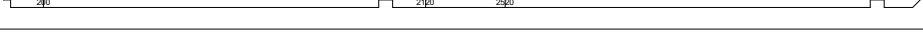

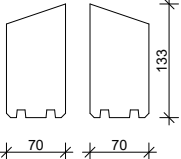
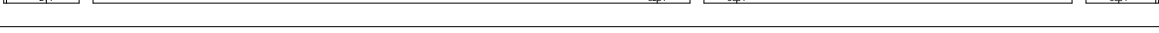





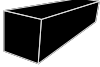

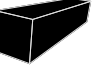
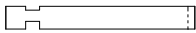
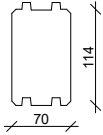

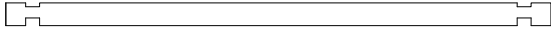
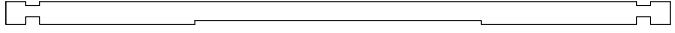

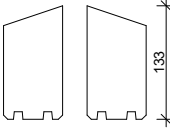
# Houston 70 mm / 700 x 1020 cm - E

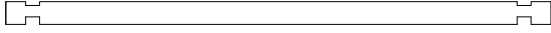
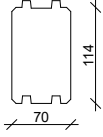
Nr.		 mm	 mm	 x
<b>E04</b>			4680+14	3
<b>E05</b>			4724	4
<b>E06</b>			2276	4
<b>E07</b>			1920	3
<b>E08</b>			5080	3
<b>E09</b>			4680+14	1
<b>E10</b>			2940	8
<b>E11</b>			1700	8
<b>E12</b>			820	8
<b>E13</b>			4724	1
<b>E14</b>			2276	1
<b>E15</b>			4724	1
<b>E16</b>			2276	1
<b>E17</b>			1632	1
<b>E18</b>			4793	1
<b>E19</b>			5710	1
<b>E20</b>			4997	1
<b>E21</b>			4283	1



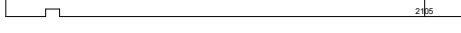







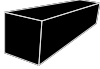

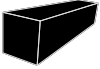
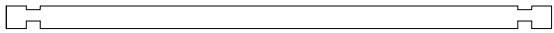
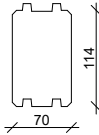

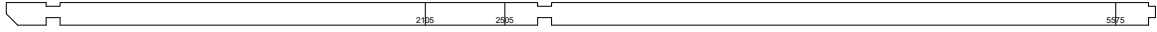

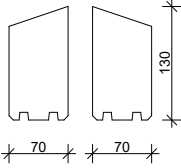
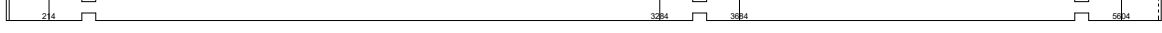
# Houston 70 mm / 700 x 1020 cm - E ; 1

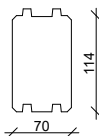
Nr.		 mm	 mm	 x
<b>E22</b>			3569	1
<b>E23</b>			2855	1
<b>E24</b>			2141	1
<b>E25</b>			1428	1
<b>E26</b>			714	1
<b>101</b>			2740	17
<b>102</b>			4660	9
<b>103</b>			710	8
<b>104</b>			1425	9
<b>105</b>			985	9
<b>106</b>			2955	1
<b>107</b>			925	1
<b>108</b>			5775	1
<b>109</b>			4625	1
<b>110</b>				2305
<b>111</b>		5790+14		1(1+0)
<b>112</b>		2305+14		1(1+0)

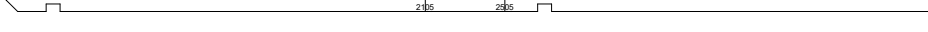
# Houston 70 mm / 700 x 1020 cm - 2 ; 3

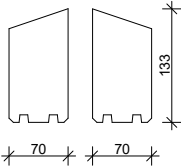

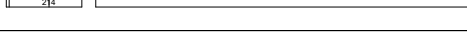
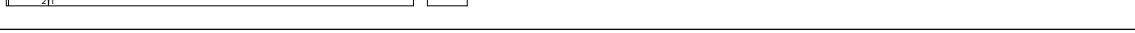
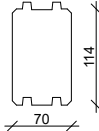





Nr.		 mm	 mm	 x
201			950	19
202			950	19
203			2740	24
204			3340	1
205			3340	1
206			3340	1(1+0)
207			2740	1(1+0)
301			2740	27
302			700	1
303			5775	1
304			4625	1
305			2305	1
306			5790+14	1
307			2305+14	1
308			5775	1
309			4625	1

# Houston 70 mm / 700 x 1020 cm - 4 ; 5

Nr.		 mm	 mm	 x
401			2740	24
402			700	1
403			4625	1
404			4625	1
405			2305	1(0+1)
406			5790+14	1(0+1)
407			2305+14	1(0+1)
501			400	19
502			700	1
503			5775	1
504			4625	1
505			2305	1(0+1)
506			5790+14	1(0+1)
507			2305+14	1(0+1)
601			5675	5
602			4525	5

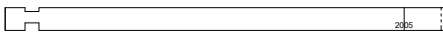
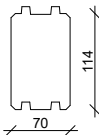
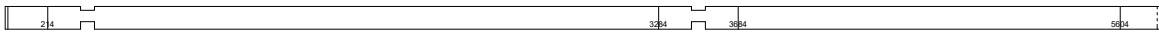
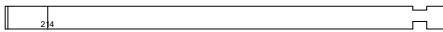
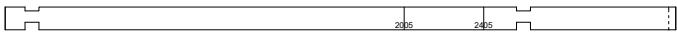
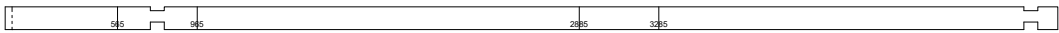
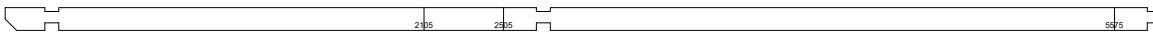
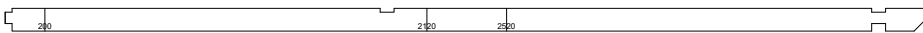

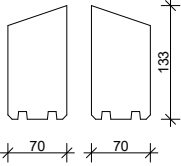
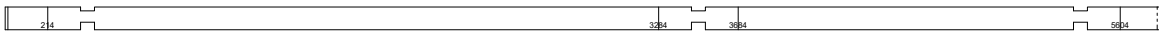
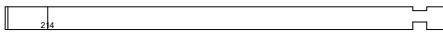
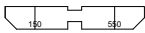
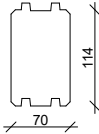
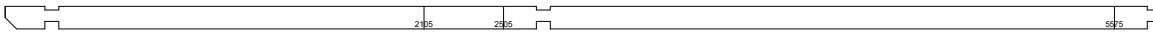
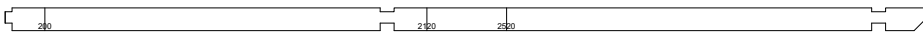
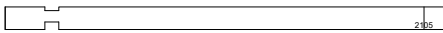
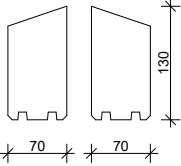
# Houston 70 mm / 700 x 1020 cm - 6 ; LT

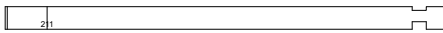
Nr.		 mm	 mm	 x	
603			2205	4	
604			5790+14	4	
605			2205+14	4	
606			3370	9	
607			5290	9	
608			5775	3	
609			4625	1	
610				2305	1(0+1)
611				5790+14	1(0+1)
612		2305+14		1(0+1)	
RB01			700	6	
RB02			5775	6	
RB03			4625	6	
RB04			2305	6(4+2)	
RB05			5790+14	6(4+2)	
RB06			2305+14	6(4+2)	