

Toledo E/170/19

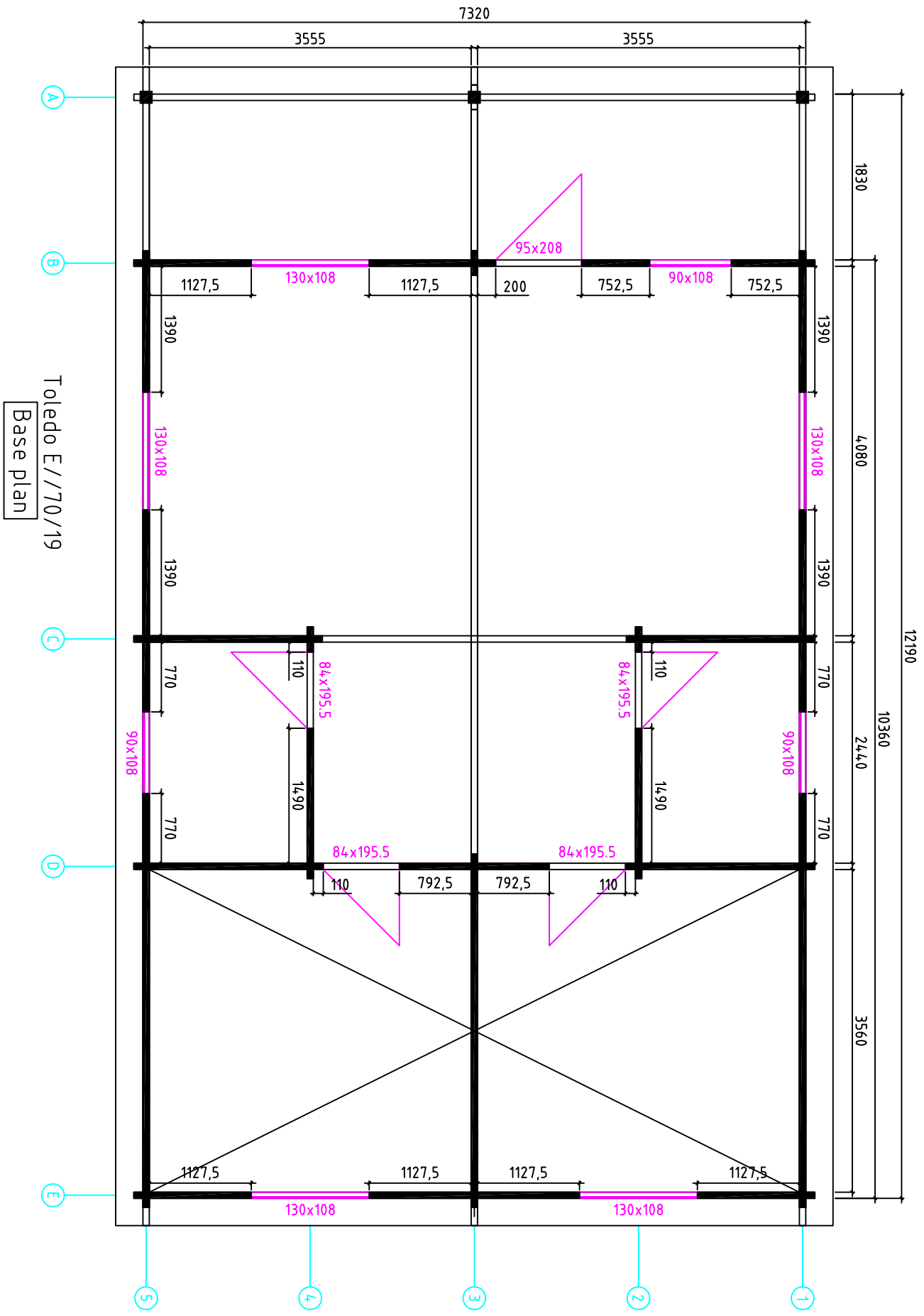

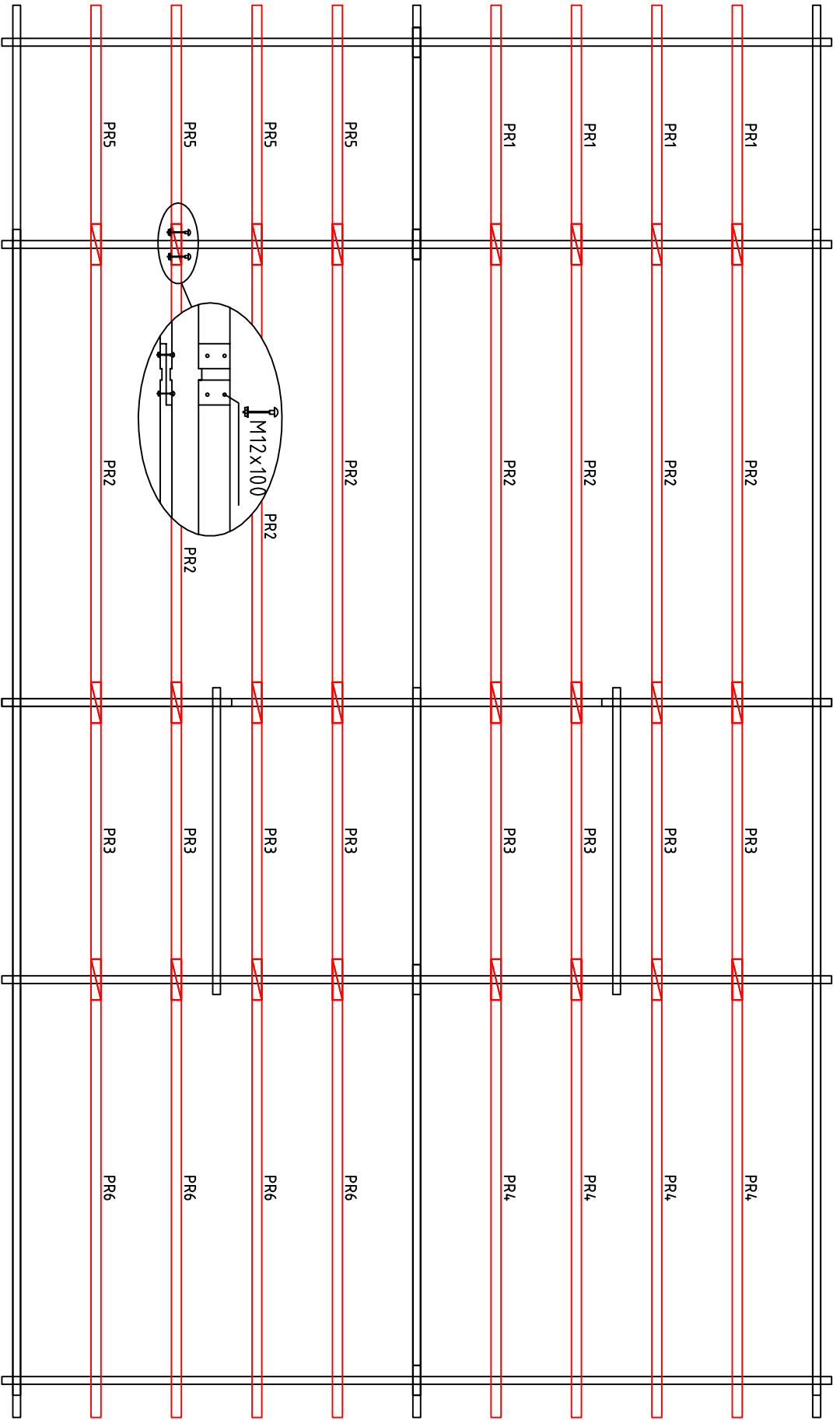

Toledo E//70/19

Purlins









Wall 5

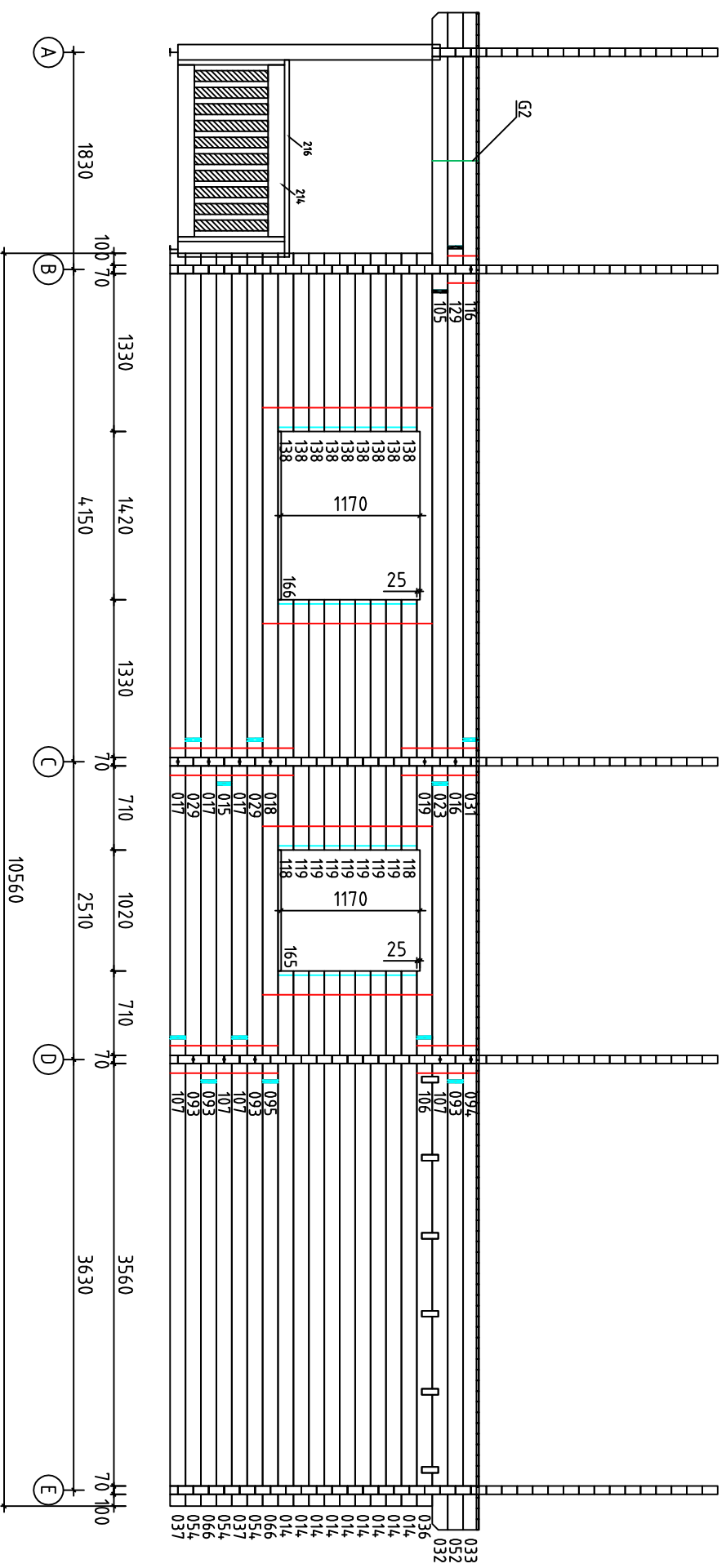

Toledo E//70/19



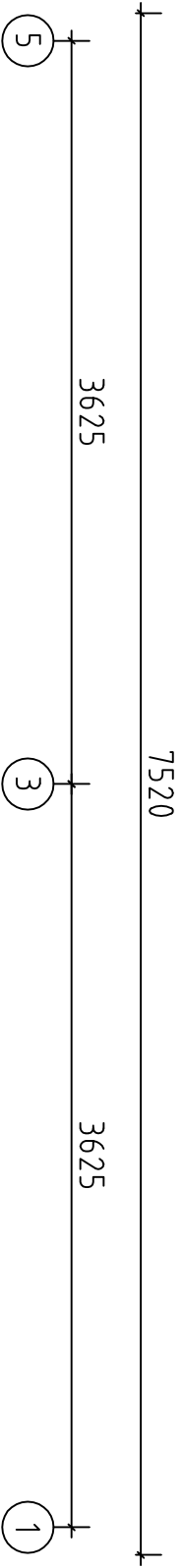
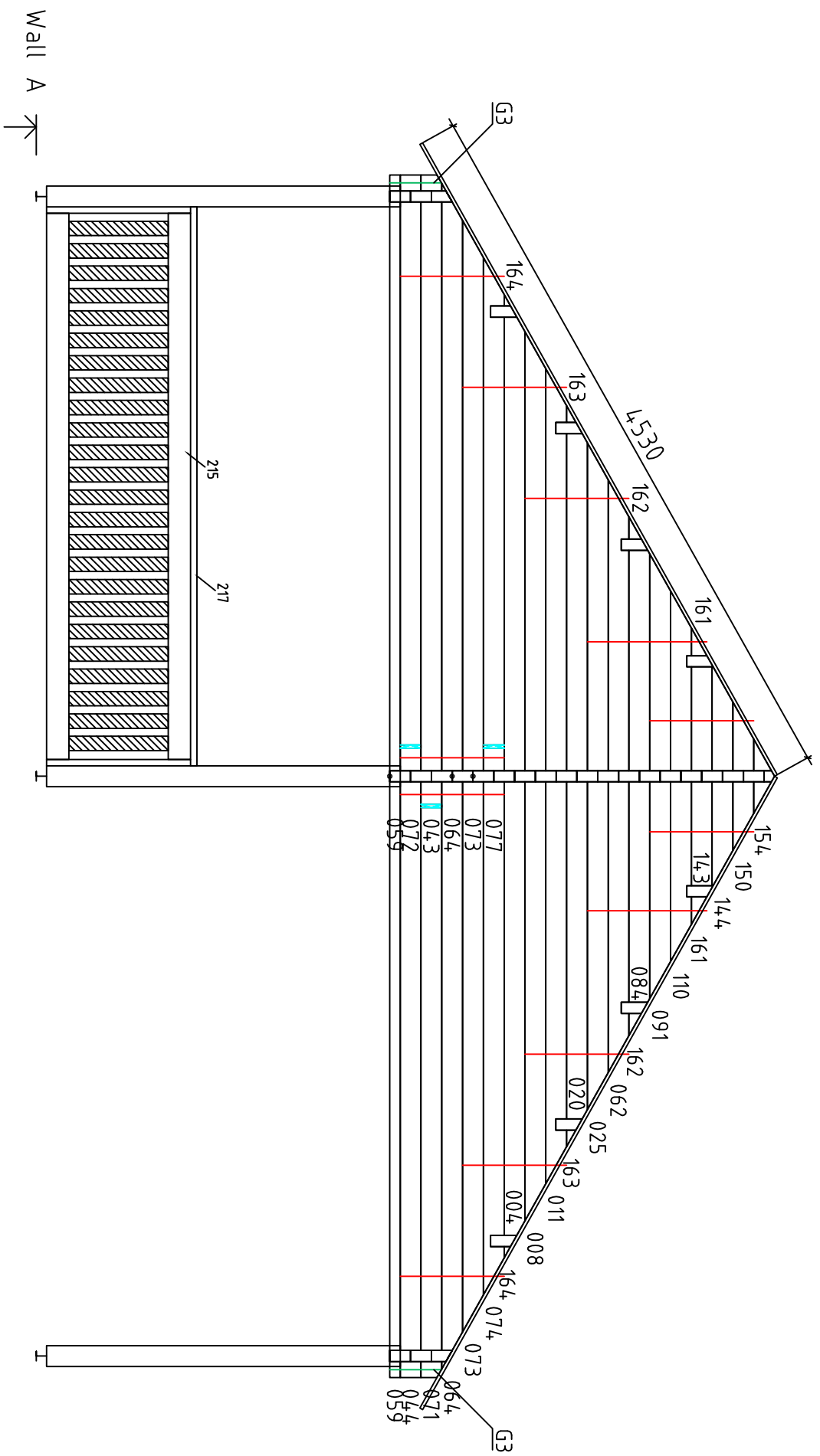

Toledo E//70/19





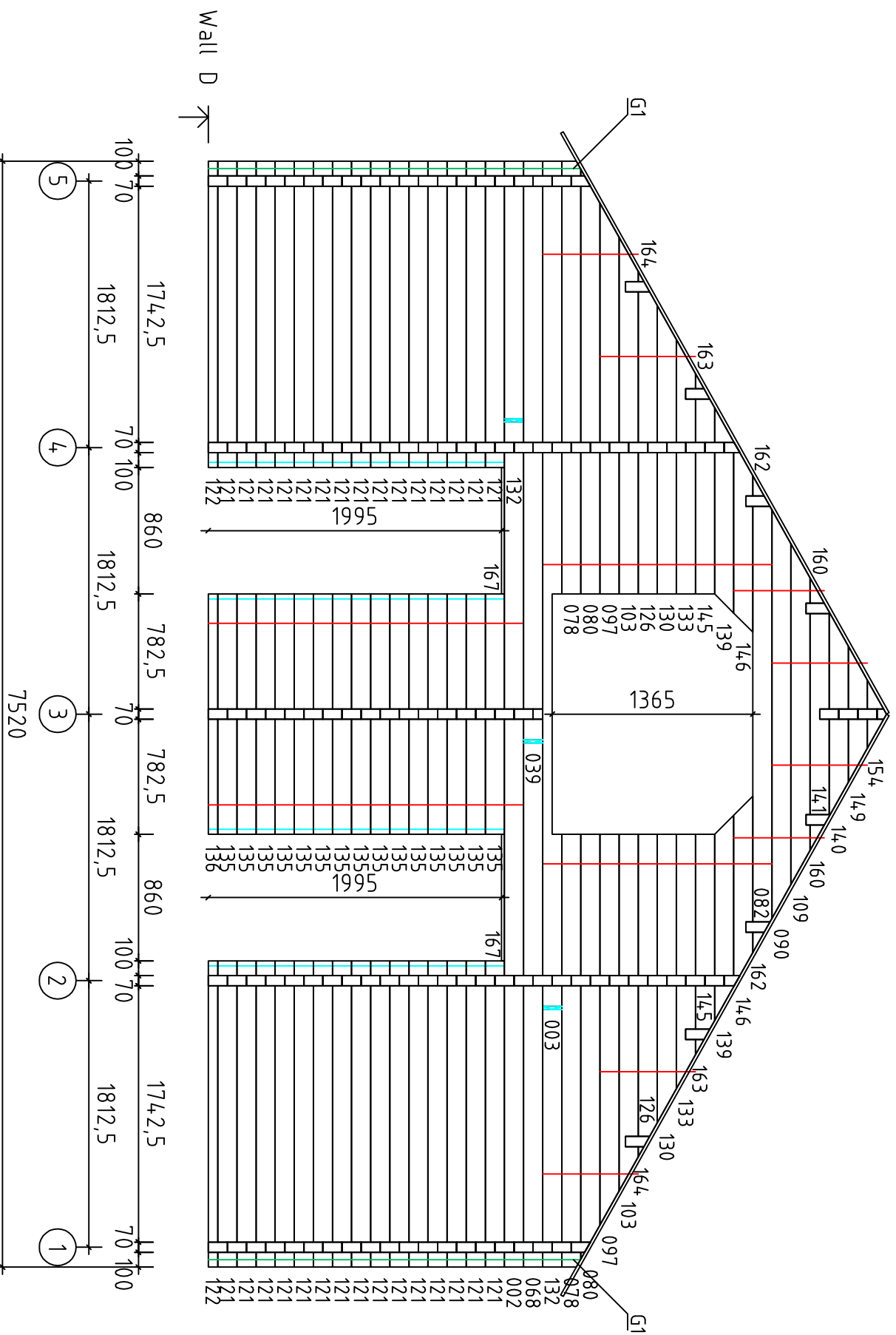



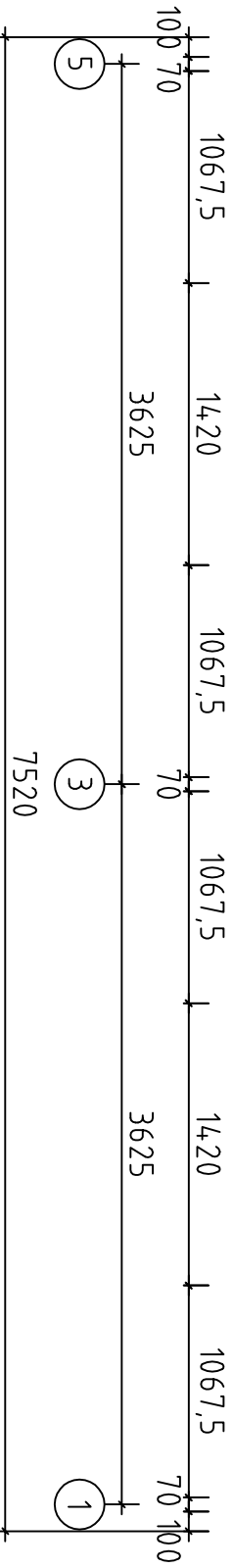
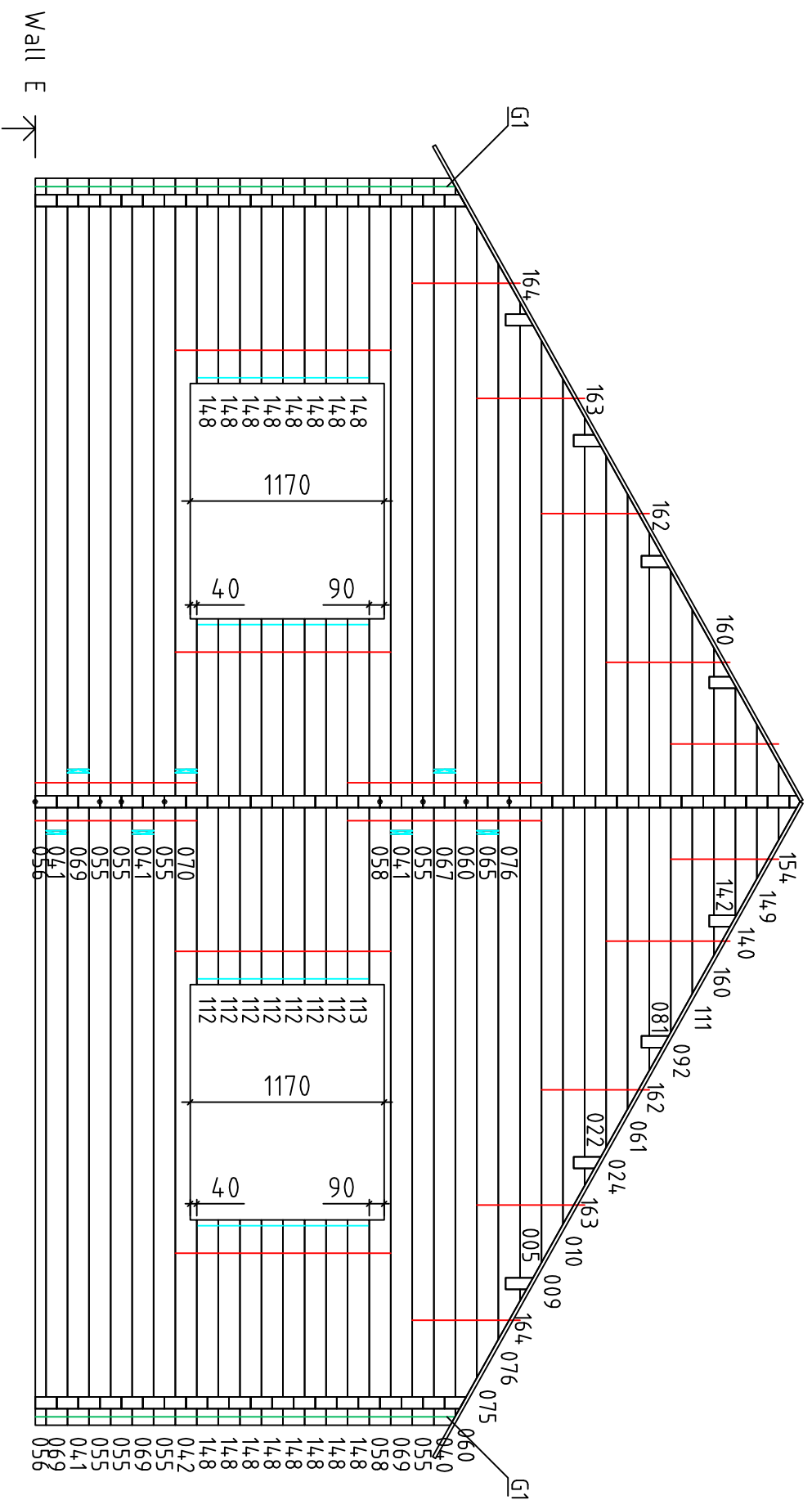

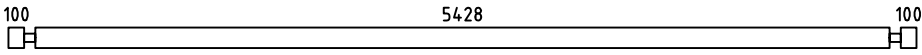
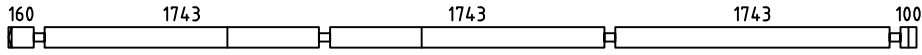
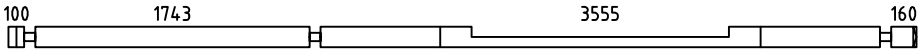
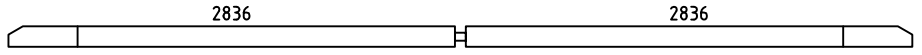
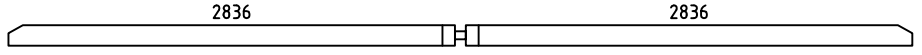
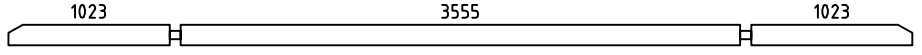
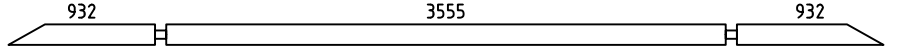
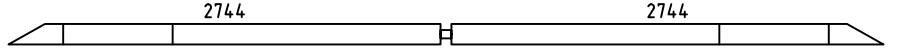
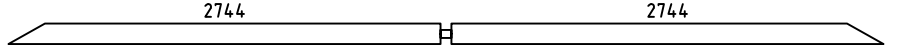
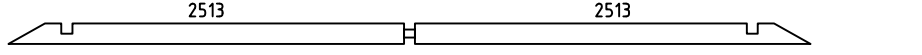
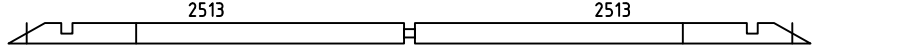
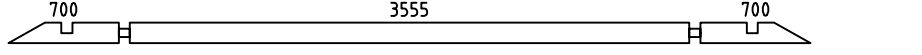
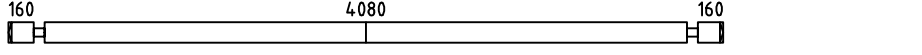
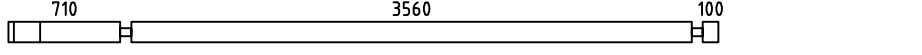
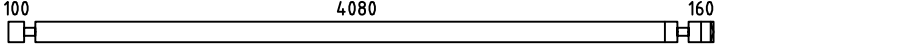
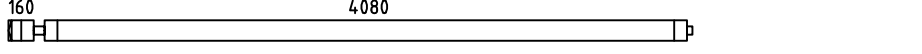
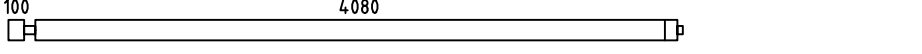
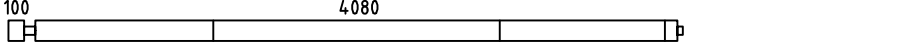
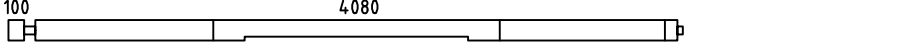
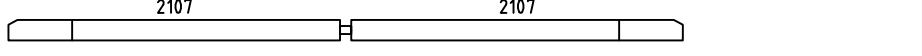
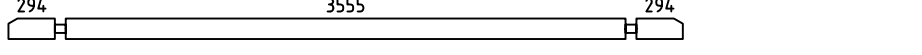
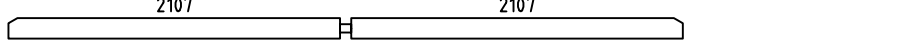
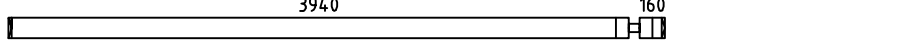
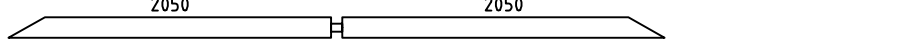
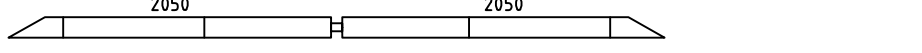

Toledo E//70/19

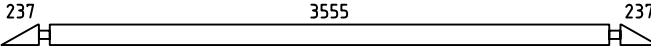
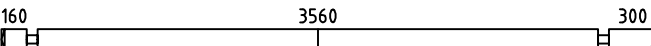
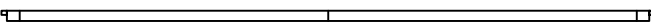
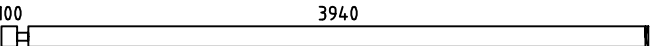
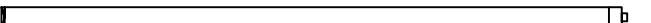
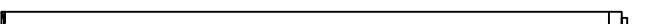
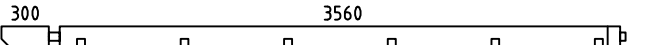
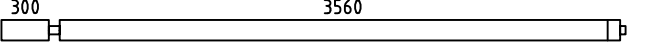
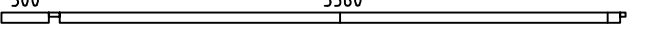
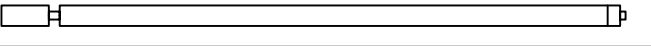
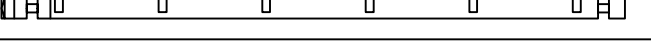
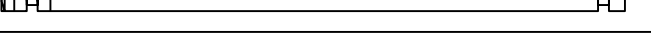
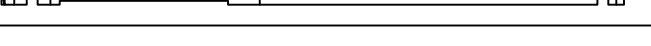

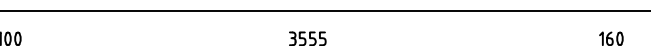
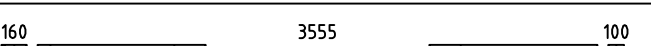
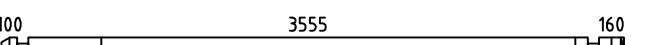
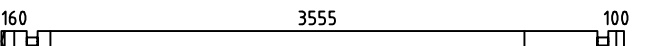
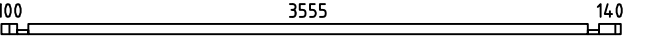
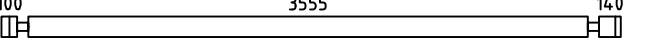
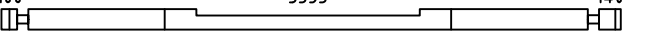
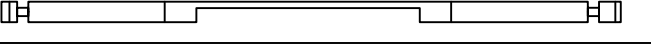
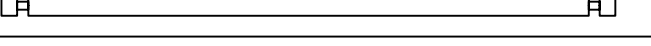
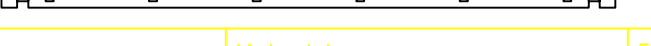

Toledo E//70/19

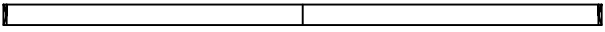
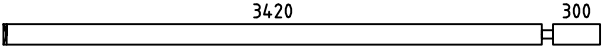
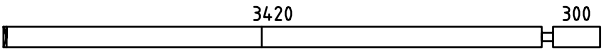
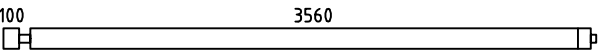
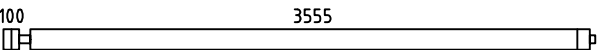
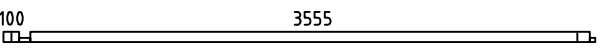
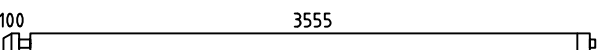
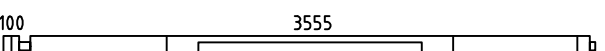
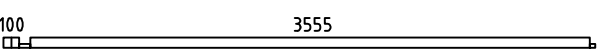
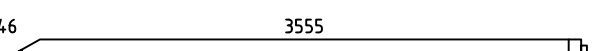

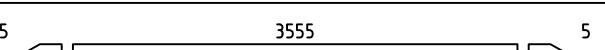
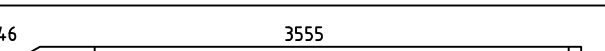
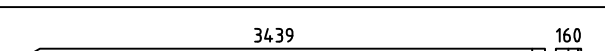
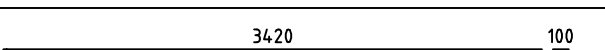
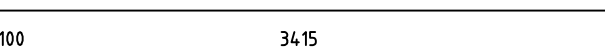
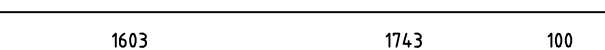
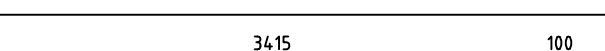
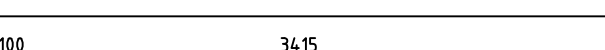
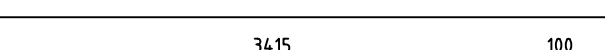
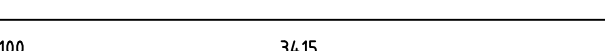
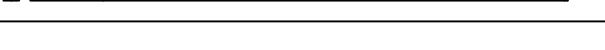
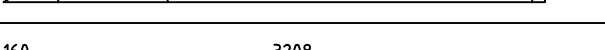
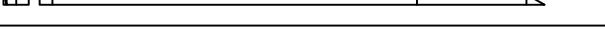
Pos	Toledo E//70/19	Q	F (mm)	L (mm)
Reserv		2	70x130	5768
002		1	70x130	5768
003		1	70x130	5767
004		1	70x130	5742
005		2	70x130	5742
006		1	70x130	5742
007		1	70x130	5559
008		1	70x130	5559
009		2	70x130	5559
010		2	70x130	5095
011		1	70x130	5095
012		1	70x130	5095
013		1	70x130	4540
014		18	70x130	4510
015		2	70x130	4480
016		2	70x130	4345
017		6	70x130	4285
018		2	70x130	4285
019		2	70x130	4285
020		1	70x130	4284
021		1	70x130	4284
022		2	70x130	4284
023		2	70x130	4170
024		2	70x130	4169
025		1	70x130	4169

Pos	Toledo E//70/19	Q	F (mm)	L (mm)
026		1	70x130	4169
027		1	70x130	4160
028		1	70x65	4150
029		4	70x130	4110
030		1	70x130	3975
031		1	70x130	3975
032		2	70x130	3965
033		1	70x130	3965
034		1	70x65	3965
035		1	70x130	3965
036		2	70x130	3960
037		4	70x130	3960
038		1	70x130	3955
039		1	70x130	3955
040		1	70x130	3955
041		5	70x130	3955
042		1	70x130	3955
043		1	70x130	3955
044		1	70x130	3955
045		1	70x65	3935
046		6	70x130	3935
047		1	70x130	3935
048		1	70x130	3935
049		16	70x130	3900
050		1	70x130	3900

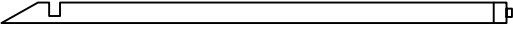
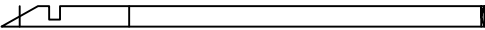
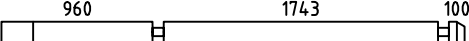
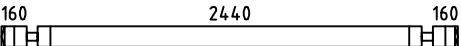
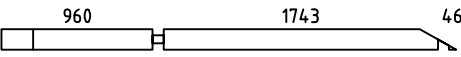
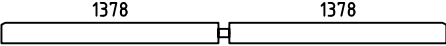

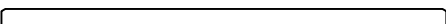
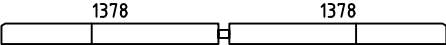
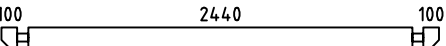
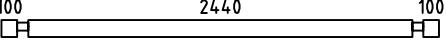
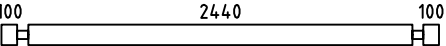
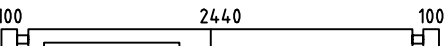
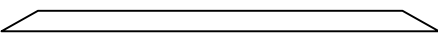
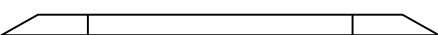
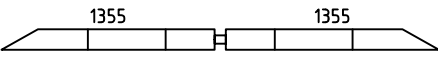
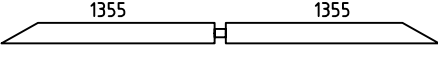
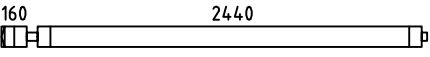
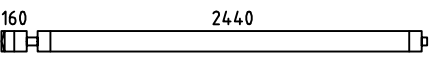
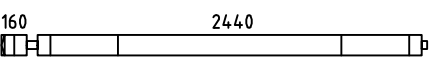
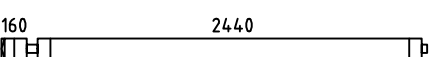
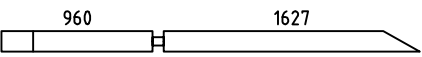
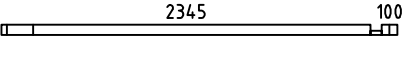
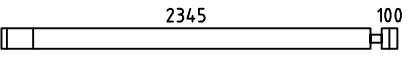
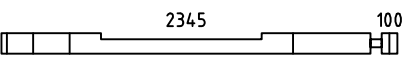

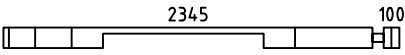
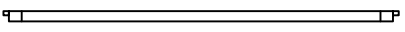
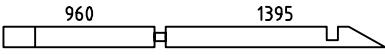
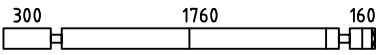
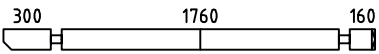
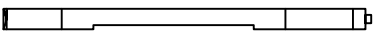
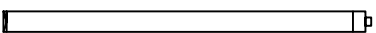
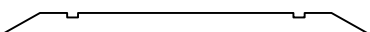
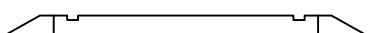
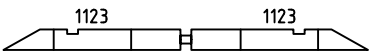
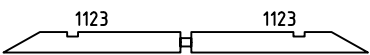
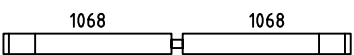

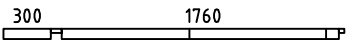
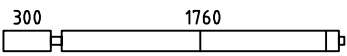
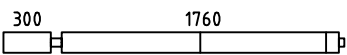
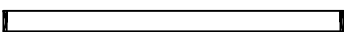
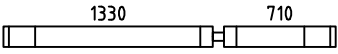
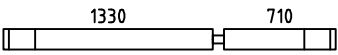
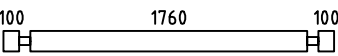
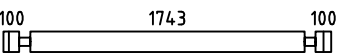
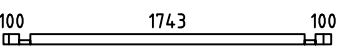
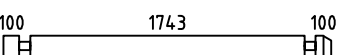
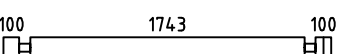
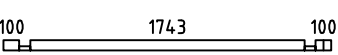

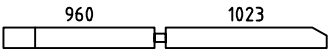
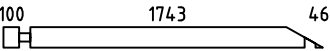
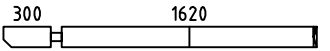
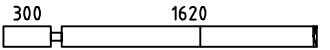
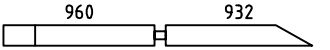
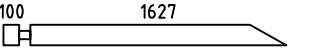
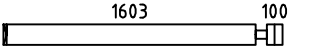
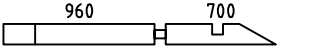
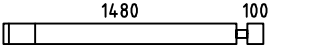
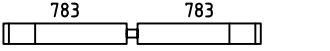
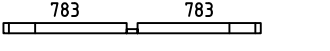
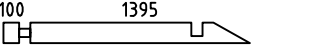
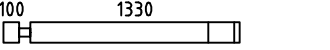
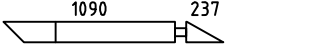
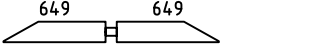
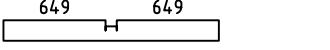
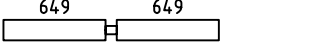
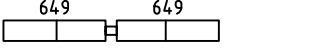
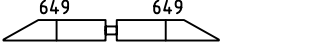
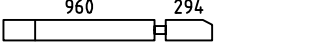
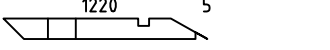
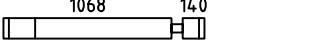
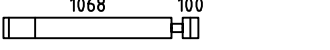
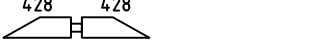
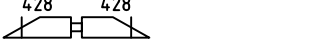

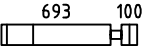
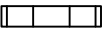





Pos	Toledo E//70/19	Q	F (mm)	L (mm)
051		1	70x130	3800
052		2	70x130	3790
053		1	70x130	3790
054		6	70x130	3765
055		8	70x130	3760
056		2	70x65	3760
057		2	70x130	3760
058		2	70x130	3760
059		2	70x65	3760
060		4	70x130	3706
061		2	70x130	3706
062		1	70x130	3706
063		1	70x130	3706
064		2	70x130	3706
065		2	70x130	3669
066		4	70x130	3590
067		1	70x130	3585
068		1	70x130	3585
069		6	70x130	3585
070		1	70x130	3585
071		1	70x130	3585
072		1	70x130	3585
073		2	70x130	3474
074		1	70x130	3438
075		2	70x130	3299











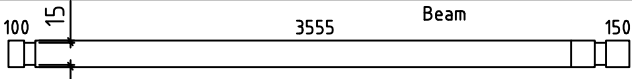
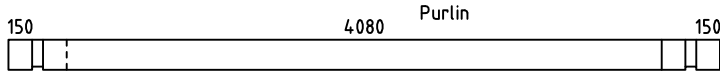
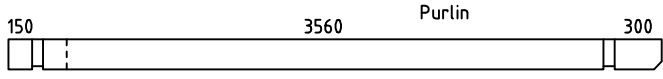
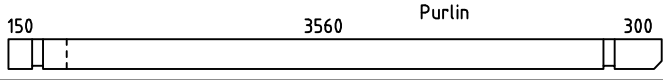
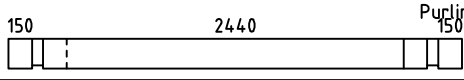
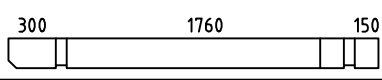
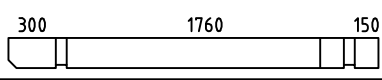

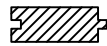
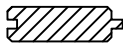
Pos	Toledo E//70/19	Q	F (mm)	L (mm)
076		4	70x130	3243
077		1	70x130	3068
078		2	70x130	2943
079		1	70x130	2900
080		2	70x130	2888
081		2	70x130	2826
082		1	70x130	2826
083		1	70x130	2826
084		1	70x130	2826
085		1	70x130	2780
086		2	70x107	2780
087		22	70x130	2780
088		2	70x130	2780
089		1	70x130	2779
090		1	70x130	2779
091		1	70x130	2779
092		2	70x130	2779
093		8	70x130	2705
094		1	70x130	2705
095		2	70x130	2705
096		1	70x130	2705
097		2	70x130	2657
098		1	70x65	2515
099		6	70x130	2515
100		1	70x130	2515

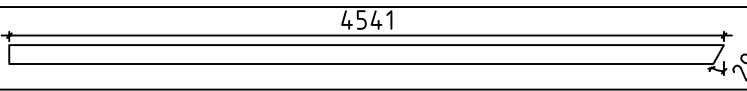
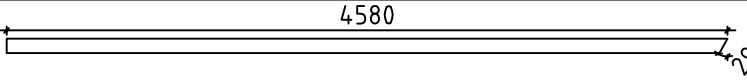
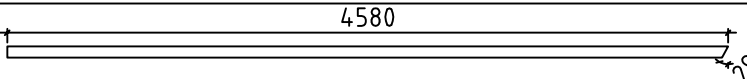
Pos	Toledo E//70/19	Q	F (mm)	L (mm)
101		1	70x130	2515
102		1	70x65	2510
103		2	70x130	2425
104		1	70x130	2360
105		2	70x130	2360
106		2	70x130	2335
107		8	70x130	2335
108		1	70x130	2316
109		1	70x130	2316
110		1	70x130	2316
111		2	70x130	2316
112		7	70x130	2205
113		1	70x130	2205
114		1	70x65	2165
115		1	70x130	2165
116		1	70x130	2165
117		1	70x130	2160
118		4	70x130	2110
119		14	70x130	2110
120		6	70x130	2100
121		30	70x130	2083
122		2	70x65	2083
123		2	70x130	2083
124		36	70x130	2083
125		2	70x65	2083

Pos	Toledo E//70/19	Q	F (mm)	L (mm)
126		2	70x130	2053
127		2	70x130	2028
128		1	70x130	1990
129		2	70x130	1990
130		2	70x130	1962
131		2	70x130	1797
132		2	70x130	1773
133		2	70x130	1730
134		30	70x130	1650
135		15	70x130	1635
136		1	70x65	1635
137		2	70x130	1565
138		18	70x130	1500
139		2	70x130	1397
140		4	70x130	1368
141		2	70x130	1368
142		2	70x130	1368
143		1	70x130	1368
144		1	70x130	1368
145		2	70x130	1324
146		2	70x130	1295
147		8	70x130	1278
148		24	70x130	1238
149		4	70x130	926
150		1	70x130	926

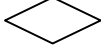
Pos	Toledo E//70/19	Q	F (mm)	L (mm)
151		8	70x130	863
152		8	70x130	633
153		5	70x65	608
154		5	70x110	463
155		4	70x130	400
156		4	70x130	400
157		1	70x65	280
158		45	70x130	270
159		30	70x130	270
160		8	70x97	172
161		2	70x97	172
162		10	70x78	138
163		10	70x58	104
164		10	70x39	70
165		2	70x25	1020
166		2	70x25	1420
167		2	70x20	860

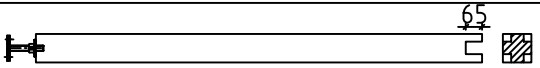
Pos	Toledo E//70/19	Q	F (mm)	L (mm)
LT1	 <p>100 15 3555 Beam 150</p>	12	70x170	3945
PR2	 <p>150 4080 Purlin 150</p>	8	90x190	4520
PR6	 <p>150 3560 Purlin 300</p>	4	90x190	4150
PR4	 <p>150 3560 Purlin 300</p>	4	90x190	4150
PR3	 <p>150 2440 Purlin 150</p>	8	90x190	2880
PR5	 <p>300 1760 Purlin 150</p>	4	90x190	2350
PR1	 <p>300 1760 Purlin 150</p>	4	90x190	2350
Kood	Materjal	File trükk (inglise).dwg	Leht 7/8	

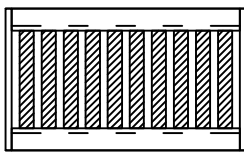
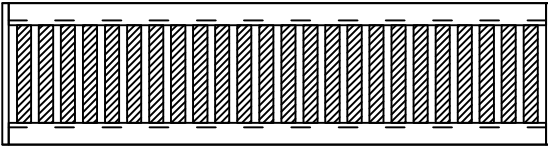
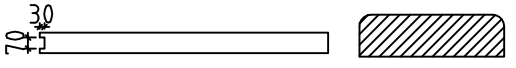
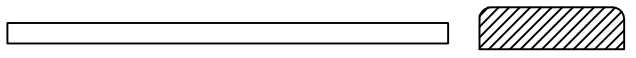
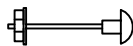
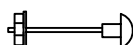
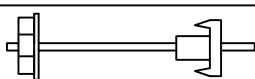
Pos	Toledo E//70/19		Q	F (mm)	L (mm)
200	Floor boards (second floor)		80	90x26	3556
201	Roof boards		286	90x20	4530
202	Baseboard			20x40	25lfm
203	Fascia board		4	20x120	4541
204	Fascia board		4	20x90	4580
205	Fascia board		4	20x70	4580
206	Gable edge board		4	20x70	4580
207	Eave edging		6	20x90	4263
208	Eave edging slat		6	40x40	4263
209	Diamond		2		
210	Dowel		698		
211	Stairs		1		
212	Post		3	130x130	2210
213	Post		2	130x130	900
214	Barrier		2		
215	Barrier		1		
216	Handrail		2	40x130	1660
217			1	40x130	3495
218	Bolts for beams		24	M12	80
210	Bolts for purlins		96	M12	100
G1	Threaded rod 12		8		2555
G2			2		410
G3			5		345

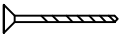
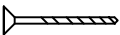
Pos	Toledo E//70/19	Q	F (mm)	L (mm)
KMPL.	Screws for boards 4x50 	2400		
	Screws for barriers and handrails 5x80 	40		
Kood	Materjal	File	trükk (inglise).dwg	Leht 8/8

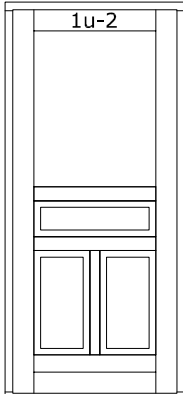
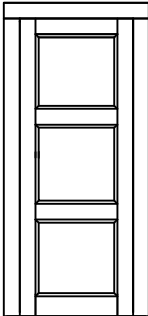
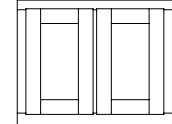
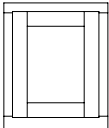
Pos	Toledo E//70/19		Q	F (mm)	L (mm)
1u-2	Sarved maha	Door 950x2080 	1L		
T1		Door 840x1955 		2L+2R	
130c		Window 1300x1080 	5		
90c		Window 900x1080 		1L+2R	
Kood	Materjal	File trükk (inglise).dwg	Leht 8/8		



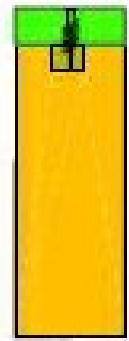
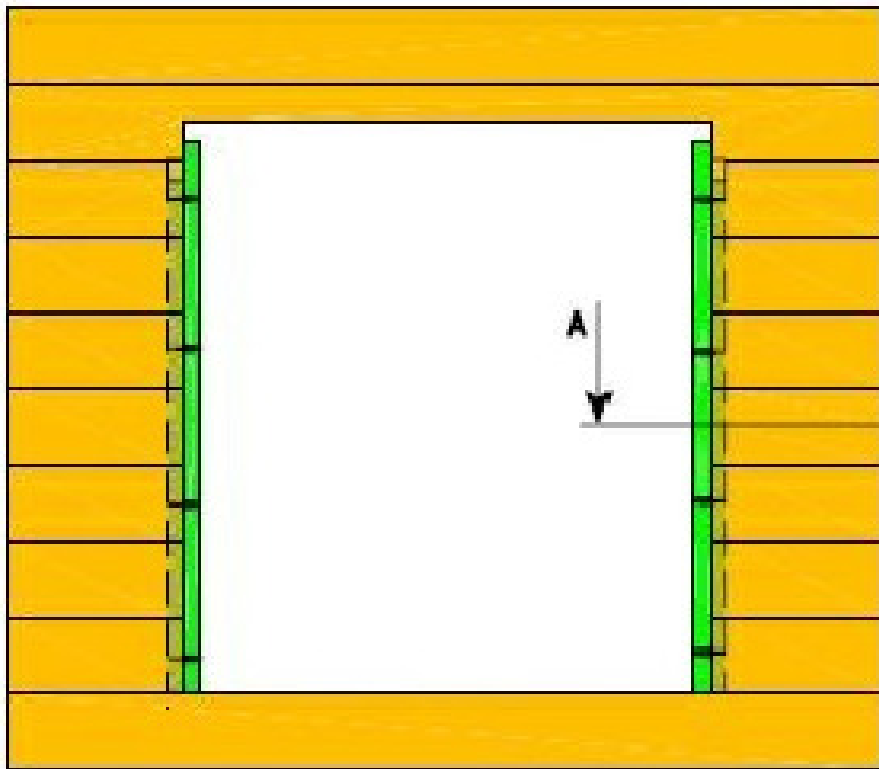

A-A

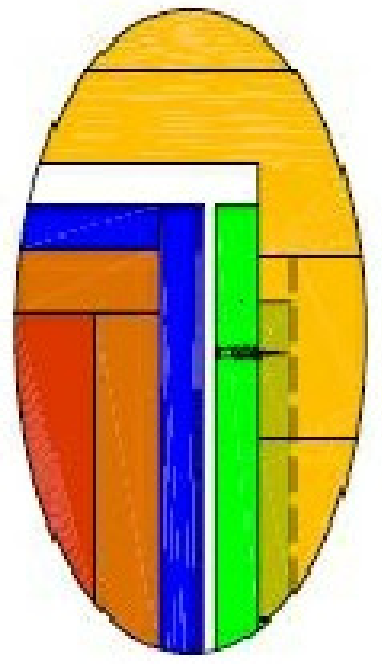

Isolation wool

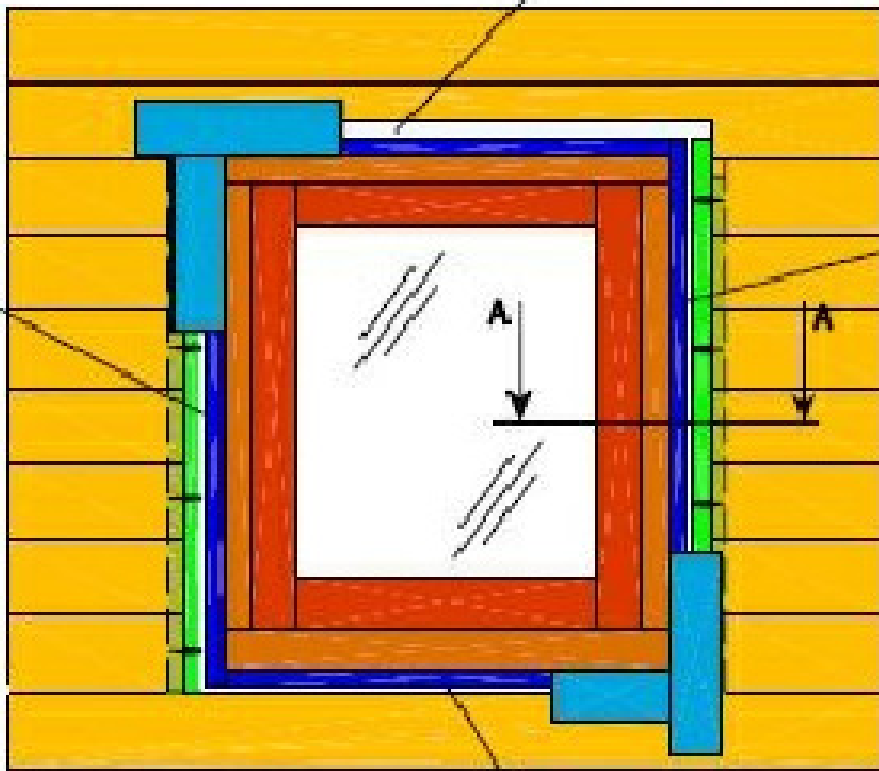

Foam

Foam

Foam

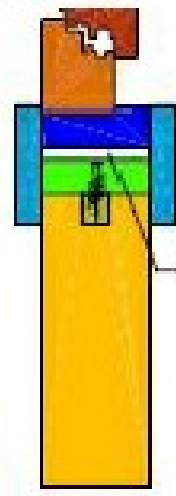

Foam

A-A