

Alabama 1 1/8" (131 7/8" x 107 7/8")

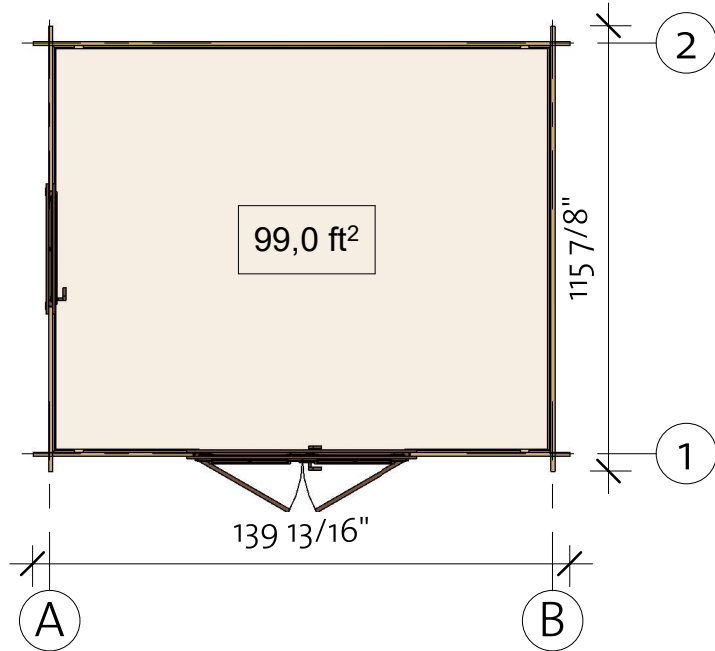

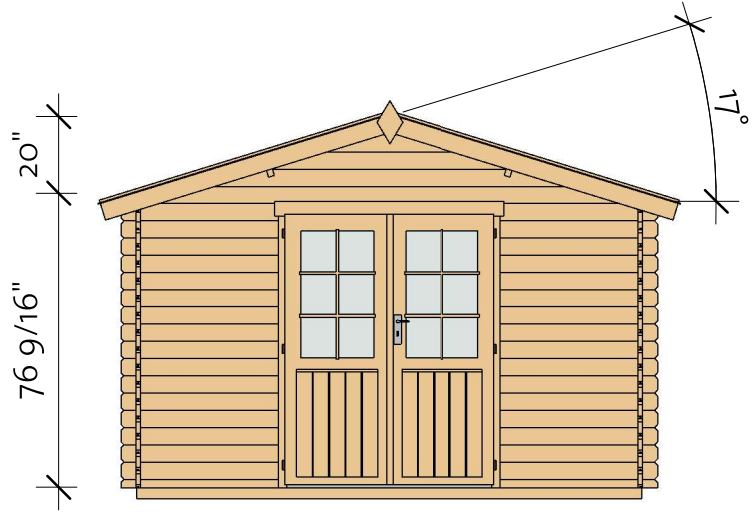
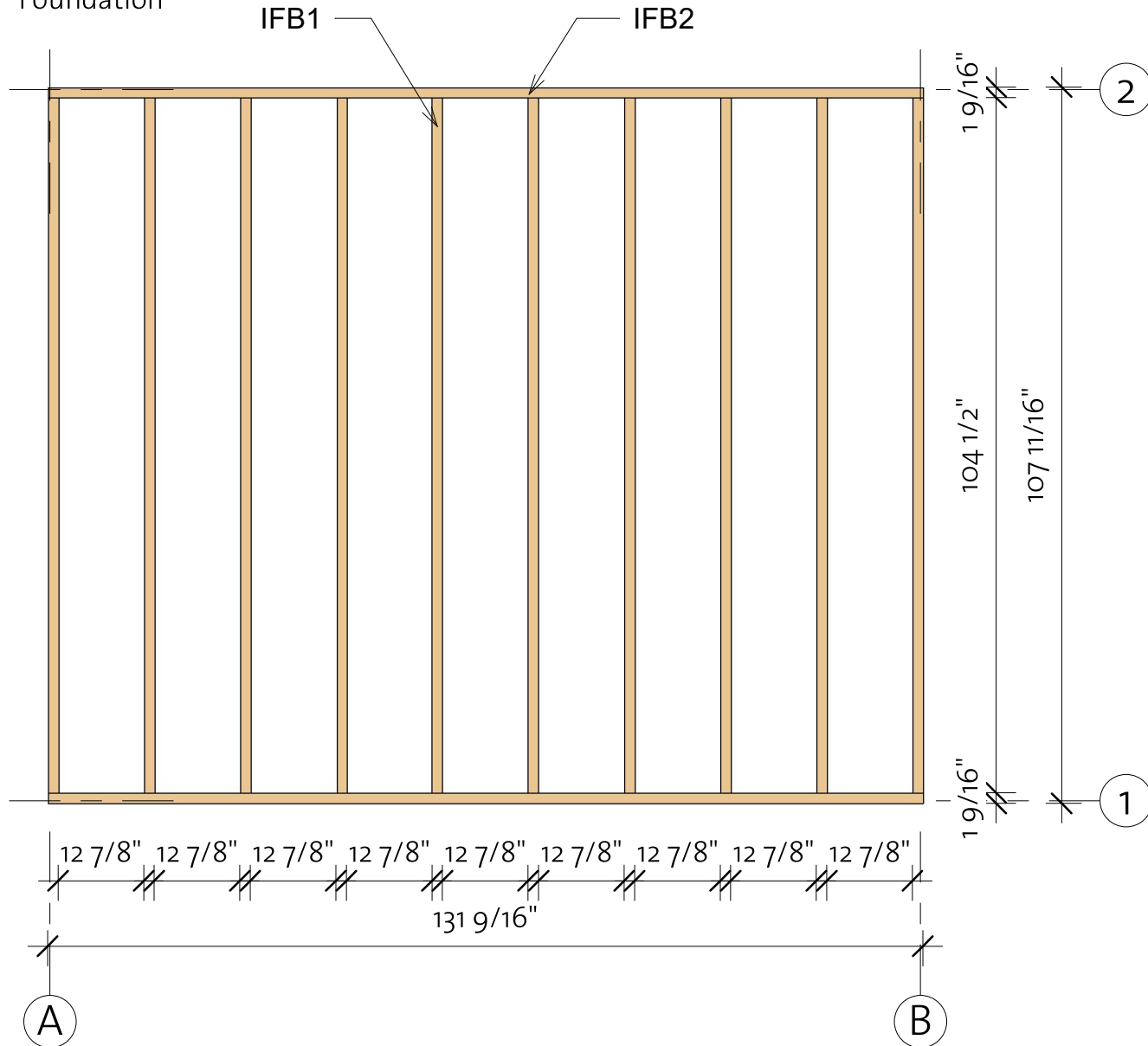

Alabama 1 1/8" (131 7/8" x 107 7/8")

Foundation



Impregnated foundation beams				
Mark	Type	Profile	Length	Count

IFB1	IFB 40x70		104 1/2"	10
IFB2	IFB 40x70		131 9/16"	2

Alabama 1 1/8" (131 7/8" x 107 7/8")

Floor Plan

① Baseboard

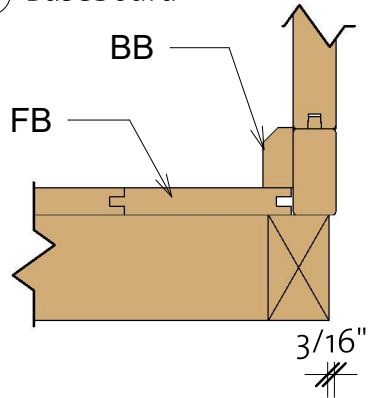

Floor Schedule

Mark	Type	Profile	Count	Length
------	------	---------	-------	--------

FB	FB 18x110		26	129 5/8"
----	--------------	--	----	-------------

BB1	BB 20x40		2	108 1/4"
BB2	BB 20x40		2	131 7/8"

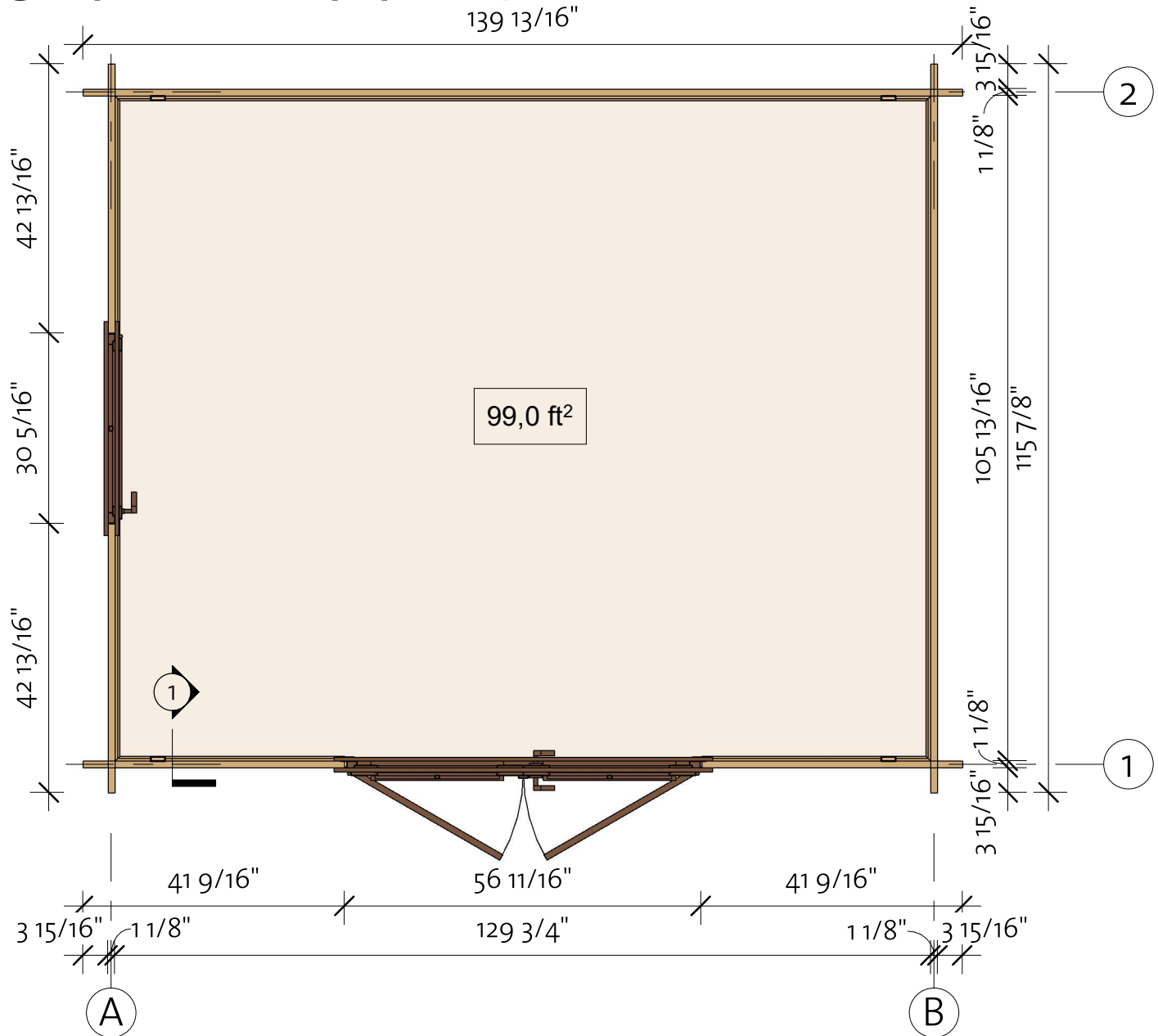

Alabama 1 1/8" (131 7/8"x107 7/8")

Wall 1

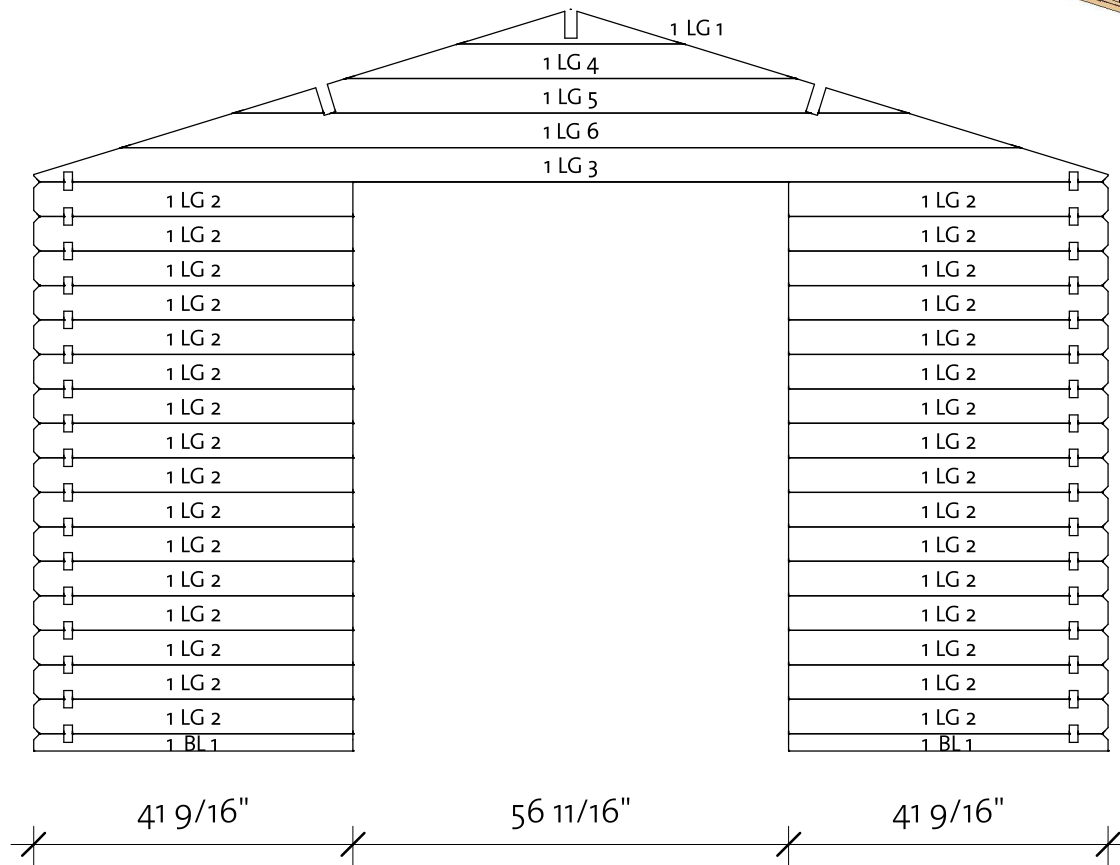
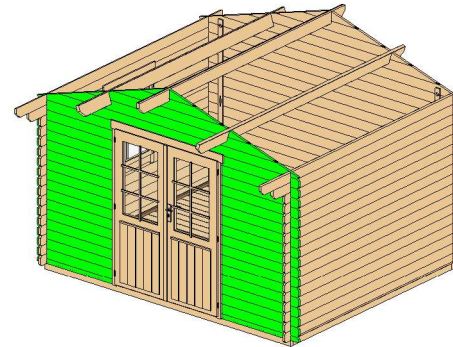

Wall 1			
Mark	Profile	Count	Cut Length

1BL 1 *	28x57	2	41 9/16"
1LG 1 *	28x114	1	29 7/16"
1LG 2* *	28x114	32	41 9/16"
1LG 3* *	28x114	1	139 13/16"
1LG 4	28x114	1	58 5/8"
1LG 5	28x114	1	87 3/4"
1LG 6	28x114	1	116 15/16"

*Gable-delivered premounted

Log Profile Wall 1	
Profile	Profile

28x57	
28x114	

Alabama 1 1/8" (131 7/8" x 107 7/8")

Wall 2

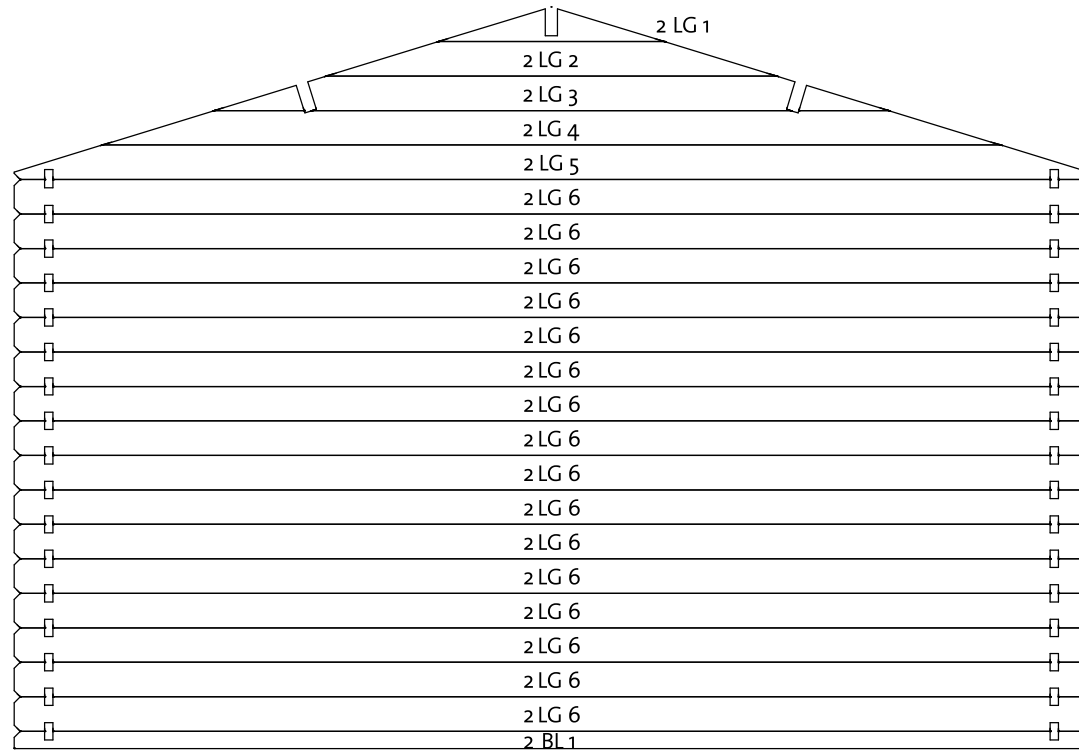
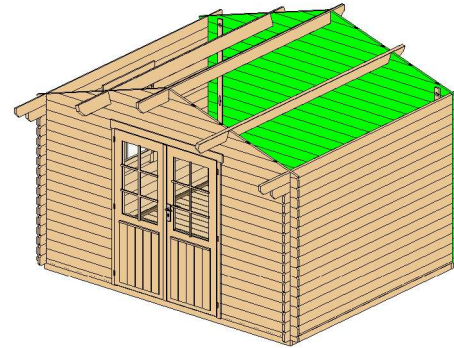

Wall 2			
Mark	Profile	Count	Cut Length

2BL 1 *	28x57	1	139 13/16"
2LG 1* *	28x114	1	29 7/16"
2LG 2*	28x114	1	58 5/8"
2LG 3*	28x114	1	87 3/4"
2LG 4	28x114	1	116 15/16"
2LG 5	28x114	1	139 13/16"
2LG 6	28x114	16	139 13/16"

*Gable-delivered premounted

Log Profile Wall 2	
Profile	Profile

28x57	
28x114	

Alabama 1 1/8" (131 7/8" x 107 7/8")

Wall A

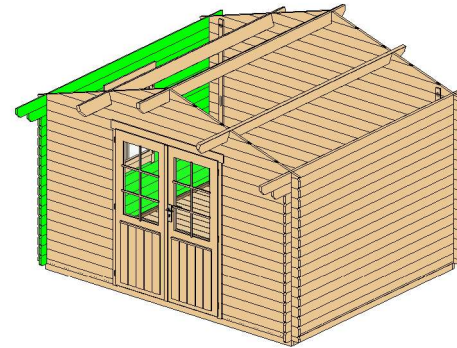

Wall A			
Mark	Profile	Count	Cut Length

ALG 1	28x114	18	42 13/16"
ALG 2	28x114	6	115 7/8"
ALG 3	28x114	1	123 3/4"
ATL 1	28x120	1	135 9/16"

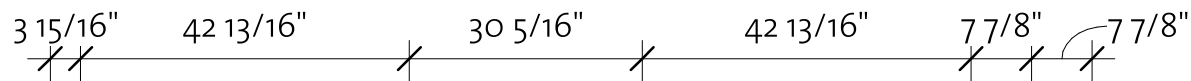
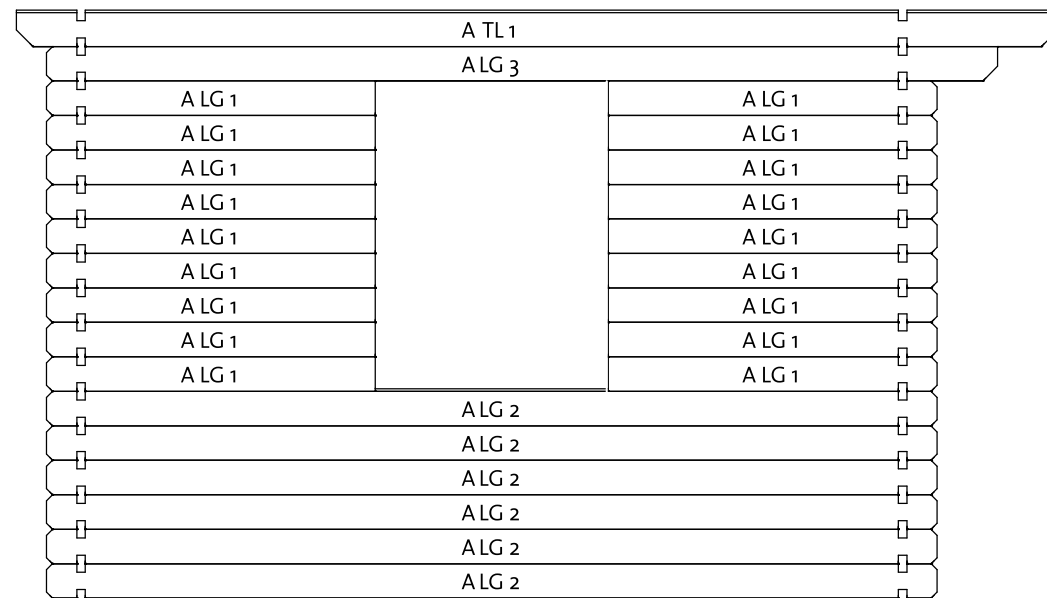

Log Profile Wall A	
Profile	Profile

28x114	
28x120	

Alabama 1 1/8" (131 7/8" x 107 7/8")

Wall B

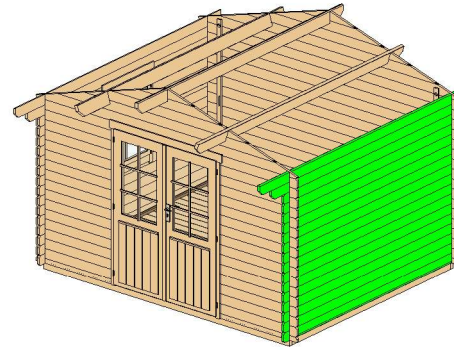

Wall B			
Mark	Profile	Count	Cut Length

BLG 1	28x114	15	115 7/8"
BLG 2	28x114	1	123 3/4"
BTL 1	28x120	1	135 9/16"

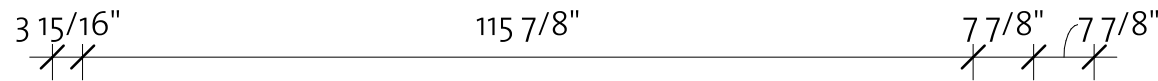
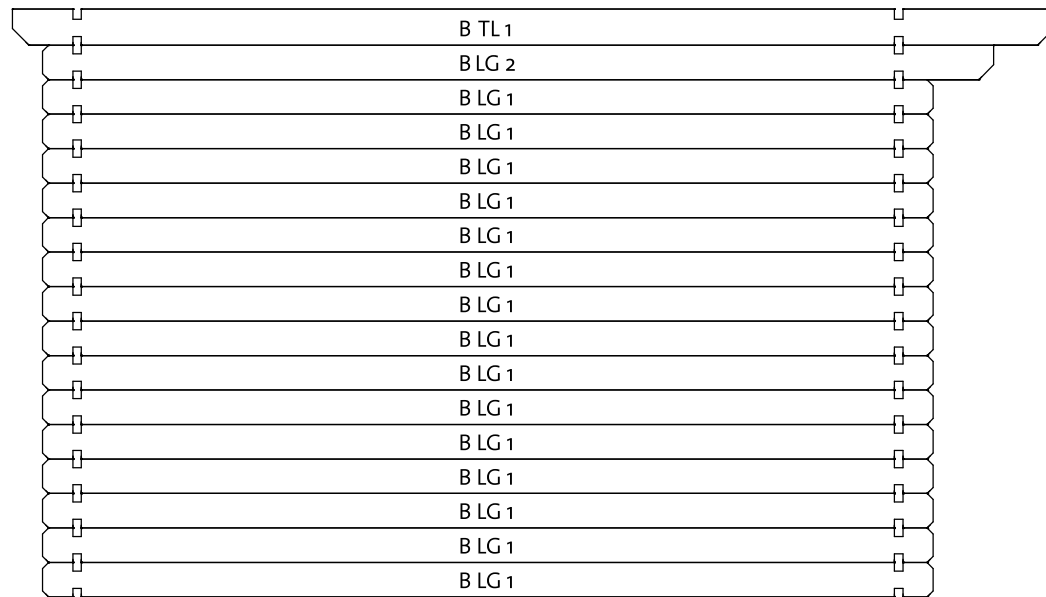





Log Profile Wall B	
Profile	Profile

28x114	
28x120	

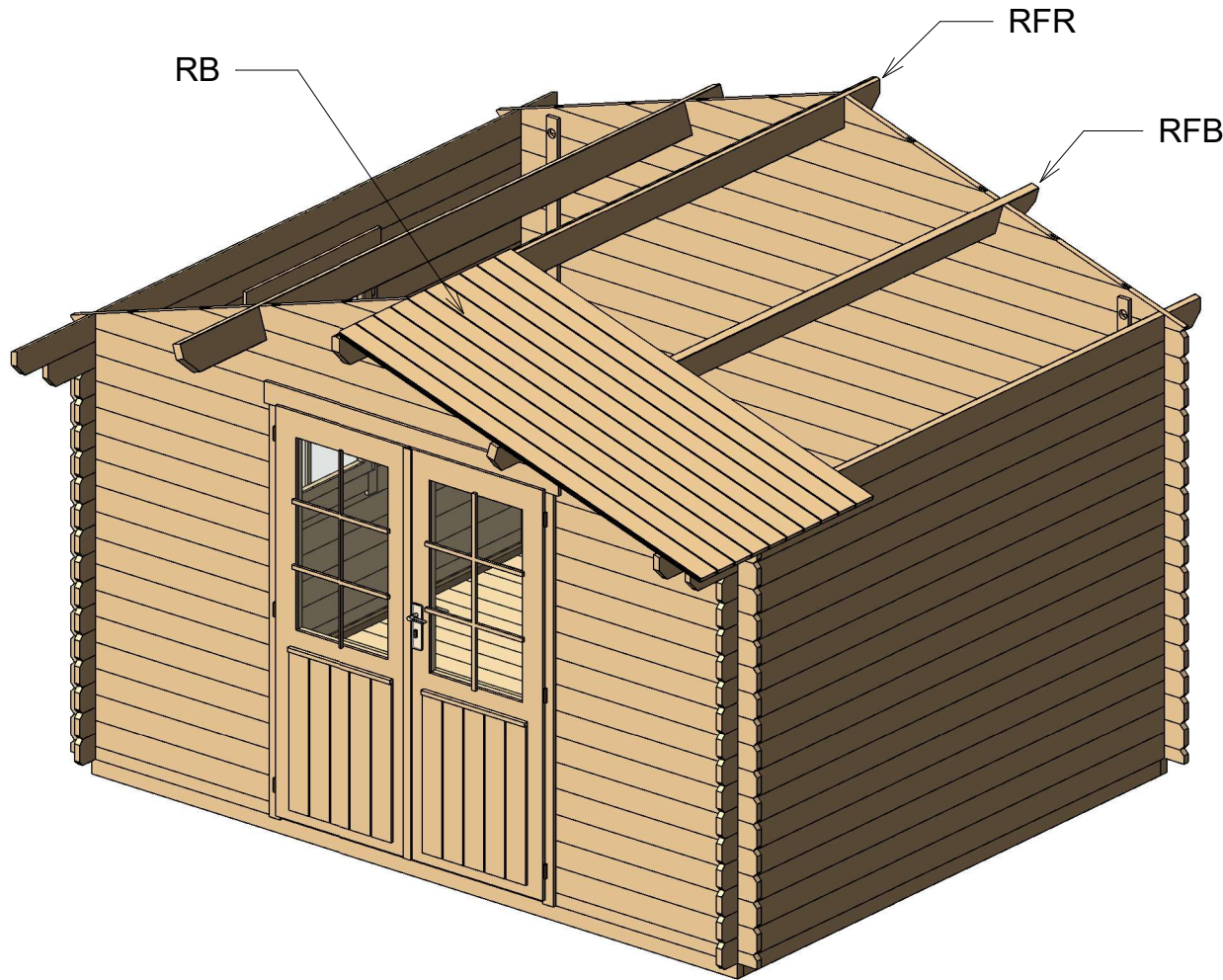
Alabama 1 1/8" (131 7/8"x107 7/8")

Roof 1



Roof				
Mark	Type	Profile	Count	Length
RFR	Ridge 40x143		1	135 9/16"
RFB	Beam 40x143		2	135 9/16"
RB	18x110		66	77 3/16"

Alabama 1 1/8" (131 7/8" x 107 7/8")

Roof 2

① Facia

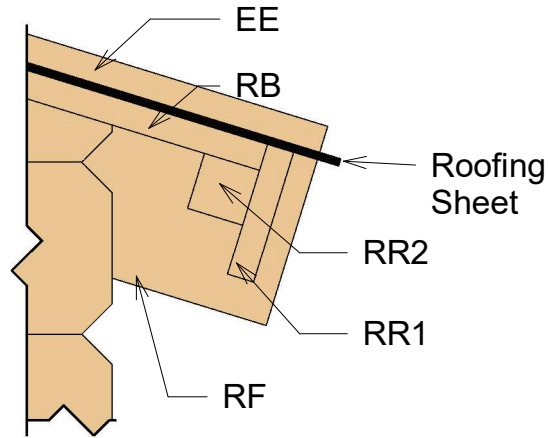
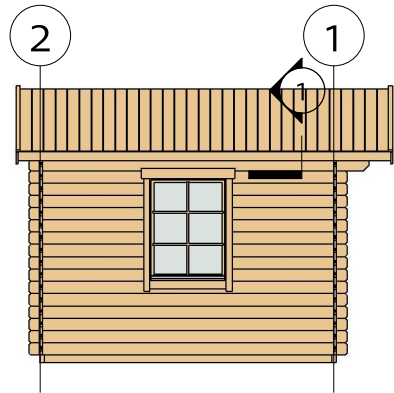

② Roof Reinforcement

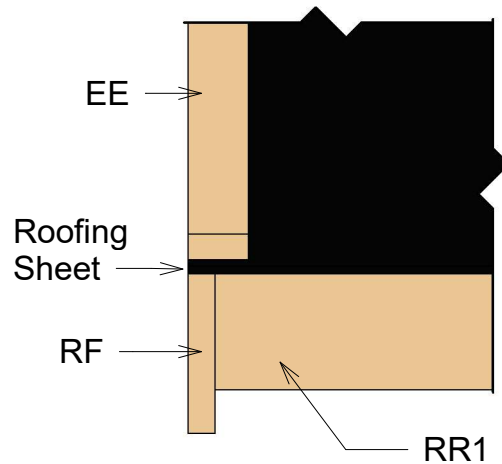
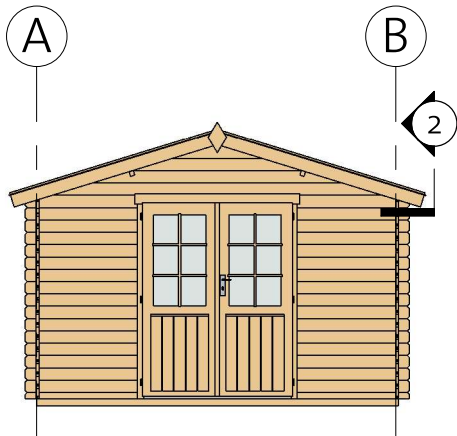

Fascia Schedule

Mark	Type	Profile	Count	Length
EE	Eave Edging 18x40		4	78 3/4"
RF	Roof Fascia 18x115		4	78 3/4"
RR1	Roof reinforcement 18x90		2	135 9/16"
RR2	Roof reinforcement 38x38		2	135 9/16"

Alabama 1 1/8" (131 7/8" x 107 7/8")

Extras

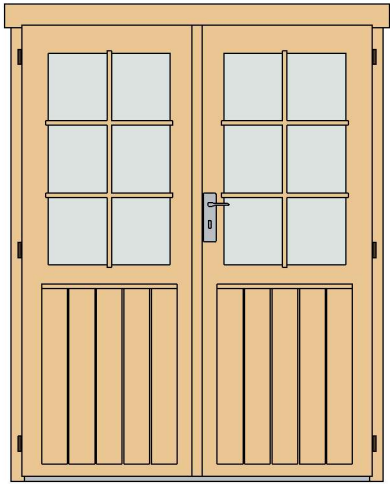

Door Schedule				
Model	Type	Width	Height	Count
BDD5R	Basic double door 5 right	56 1/8"	72 1/4"	1
DCB6	Door crossbar 6	--	--	2

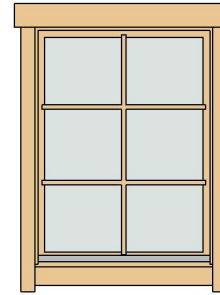

Window Schedule				
Model	Type	Width	Height	Count
BW1R	Basic window 1 right	30 1/8"	39"	1
WCB6	Window crossbar 6	--	--	1

Fasteners/Extras		
Name	Comments	Count

Hitblock	11 13/16"-15 3/4"	
Screws	3/16" x 2 3/4"	10
Bolts	M5/16" x 2 3/8"	12
Nails	1/16" x 1 9/16"	30
Screws	1/4" x 5 1/2"	45
Screws	3/16" x 1 9/16"	65
Screws	3/16" x 2"	500



Type	Count	Length
Windboard 18x40	4	86 5/8"





Type	Count
Romb	2



Alabama 1 1/8" (131 7/8"x107 7/8")

List of all items 1



Impregnated foundation beams				
Mark	Type	Profile	Length	Count

IFB1	IFB 40x70		104 1/2"	10
IFB2	IFB 40x70		131 9/16"	2





Floor Schedule				
Mark	Type	Profile	Count	Length

FB	FB 18x110		26	129 5/8"
BB1	BB 20x40		2	108 1/4"
BB2	BB 20x40		2	131 7/8"

Roof				
Mark	Type	Profile	Count	Length

RFR	Ridge 40x143		1	135 9/16"
RFB	Beam 40x143		2	135 9/16"
RB	18x110		66	77 3/16"

Fascia Schedule				
Mark	Type	Profile	Count	Length

EE	Eave Edging 18x40		4	78 3/4"
RF	Roof Fascia 18x115		4	78 3/4"
RR1	Roof reinforcement 18x90		2	135 9/16"
RR2	Roof reinforcement 38x38		2	135 9/16"

Alabama 1 1/8" (131 7/8"x107 7/8")

List of all items 2

Wall 1			
Mark	Profile	Count	Cut Length

1BL 1	28x57	2	41 9/16"
1LG 1*	28x114	1	29 7/16"
1LG 2	28x114	32	41 9/16"
1LG 3*	28x114	1	139 13/16"
1LG 4*	28x114	1	58 5/8"
1LG 5*	28x114	1	87 3/4"
1LG 6*	28x114	1	116 15/16"

Wall 2			
Mark	Profile	Count	Cut Length

2BL 1	28x57	1	139 13/16"
2LG 1*	28x114	1	29 7/16"
2LG 2*	28x114	1	58 5/8"
2LG 3*	28x114	1	87 3/4"
2LG 4*	28x114	1	116 15/16"
2LG 5*	28x114	1	139 13/16"
2LG 6	28x114	16	139 13/16"

Wall A			
Mark	Profile	Count	Cut Length



ALG 1	28x114	18	42 13/16"
ALG 2	28x114	6	115 7/8"
ALG 3	28x114	1	123 3/4"
ATL 1	28x120	1	135 9/16"

Wall B			
Mark	Profile	Count	Cut Length

BLG 1	28x114	15	115 7/8"
BLG 2	28x114	1	123 3/4"
BTL 1	28x120	1	135 9/16"

*Gable-delivered premounted

Log Profiles	
Profile	Profile

28x57	
28x114	

Log Profiles	
Profile	Profile

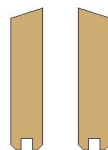
28x120	
--------	--