

# Victoria C 40 (380x380)

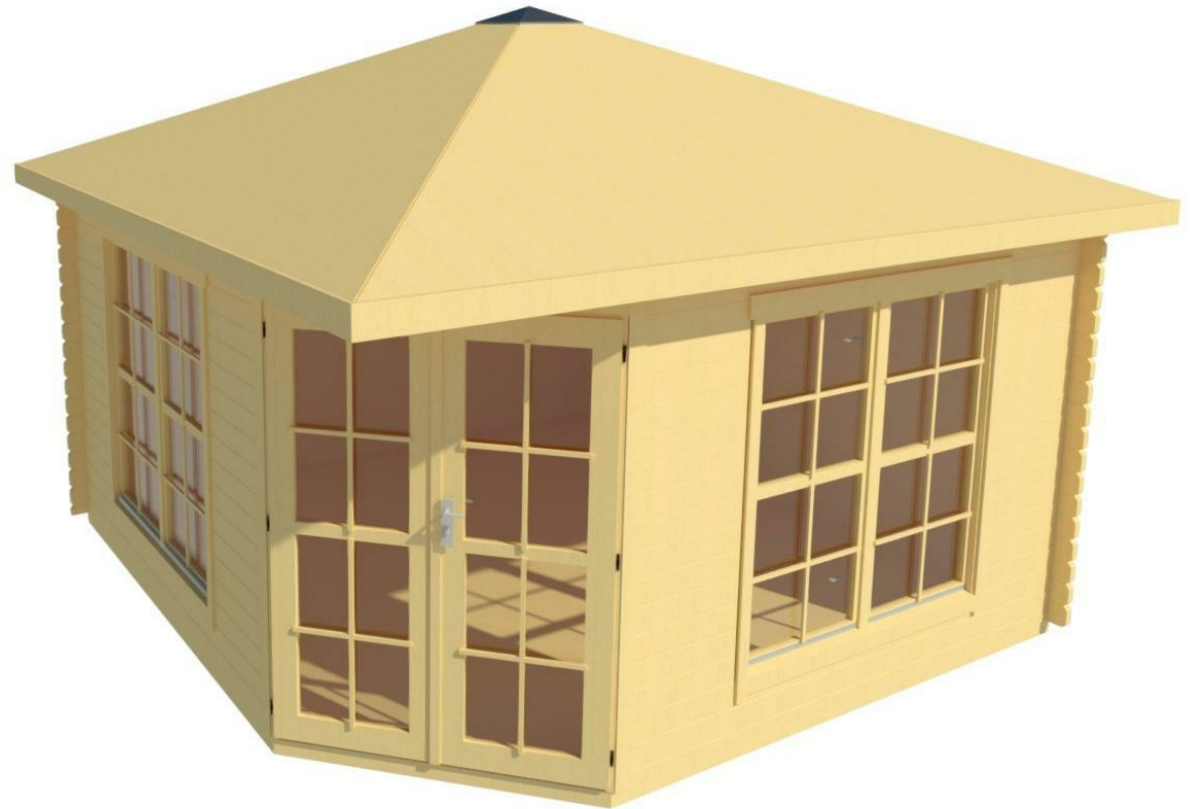

190523

# Victoria C 40 (380x380)

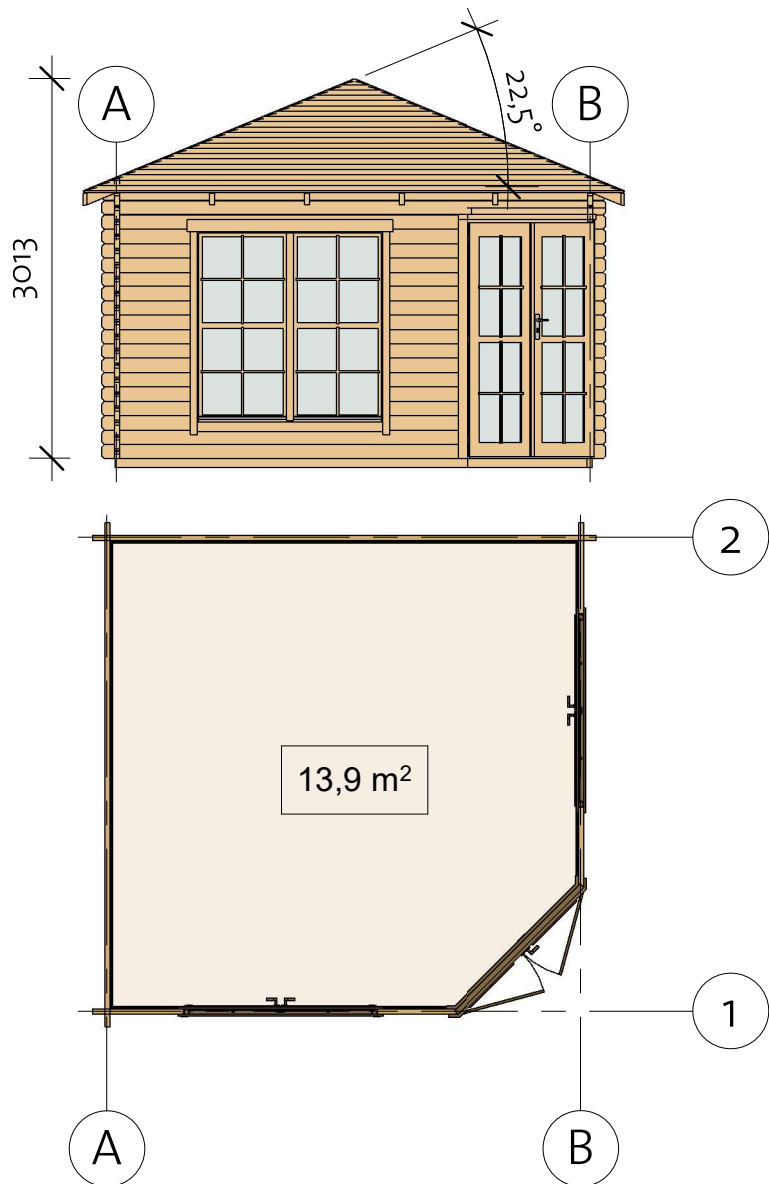
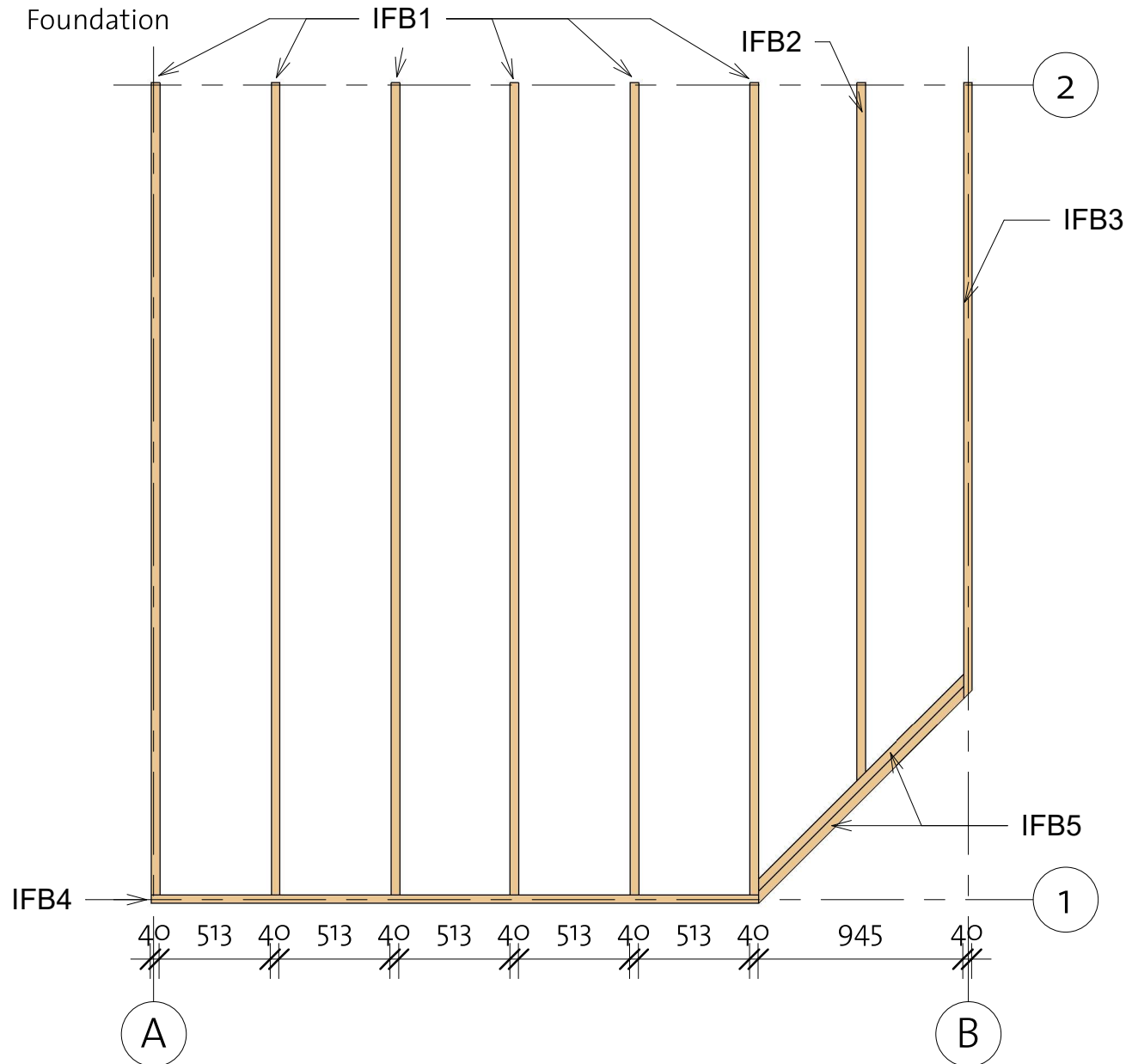

Impregnated foundation beams				
Mark	Type	Profile	Count	Length
IFB1	IFB 40x70		6	3750
IFB2	IFB 40x70		1	3224
IFB3	IFB 40x70		1	2845
IFB4	IFB 40x70		1	2805
IFB5	IFB 40x70		2	1376

# Victoria C 40 (380x380)

Floor Plan

① Baseboard

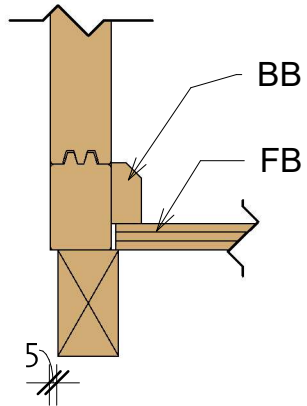

Floor Schedule

Mark	Type	Profile	Count	Length
------	------	---------	-------	--------

FB 1	FB 18x110		1	2857
FB 2	FB 18x110		1	2967
FB 3	FB 18x110		1	3077
FB 4	FB 18x110		1	3187
FB 5	FB 18x110		1	3297
FB 6	FB 18x110		1	3407
FB 7	FB 18x110		1	3517
FB 8	FB 18x110		1	3627
FB 9	FB 18x110		1	3717
FB 10	FB 18x110		26	3717

BB	BB 20x40		4	3800
----	----------	---------------------------------------------------------------------------------------	---	------

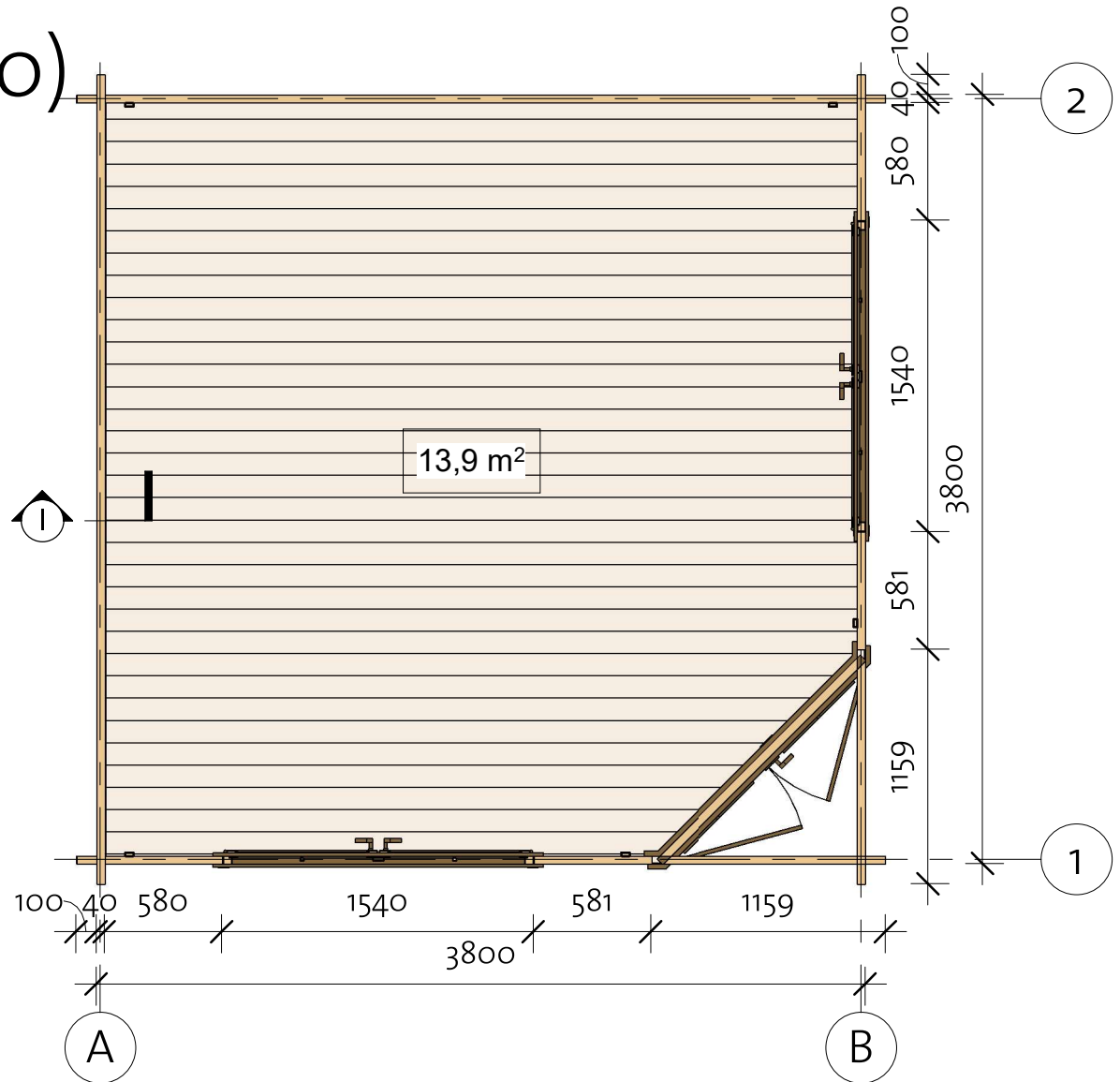

# Victoria C 40 (380x380)

Wall 1

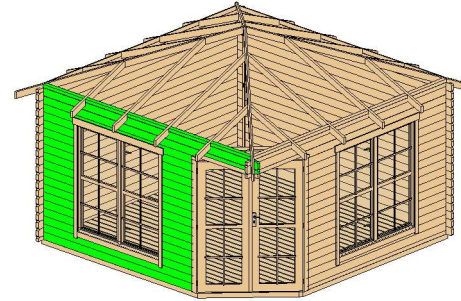

Wall 1			
Mark	Profile	Count	Cut Length

1LG-1	40x114	2	2841
1LG-2	40x114	13	581
1LG-3	40x114	13	720
1LG-4	40x114	1	4000
1LG-5	40x114	1	4000
1LG-6	40x114	1	2841
1LG-7	40x114	1	2841
1TL-1	40x63	3	711
1TL-2	40x63	1	725
1TL-3	40x63	1	725

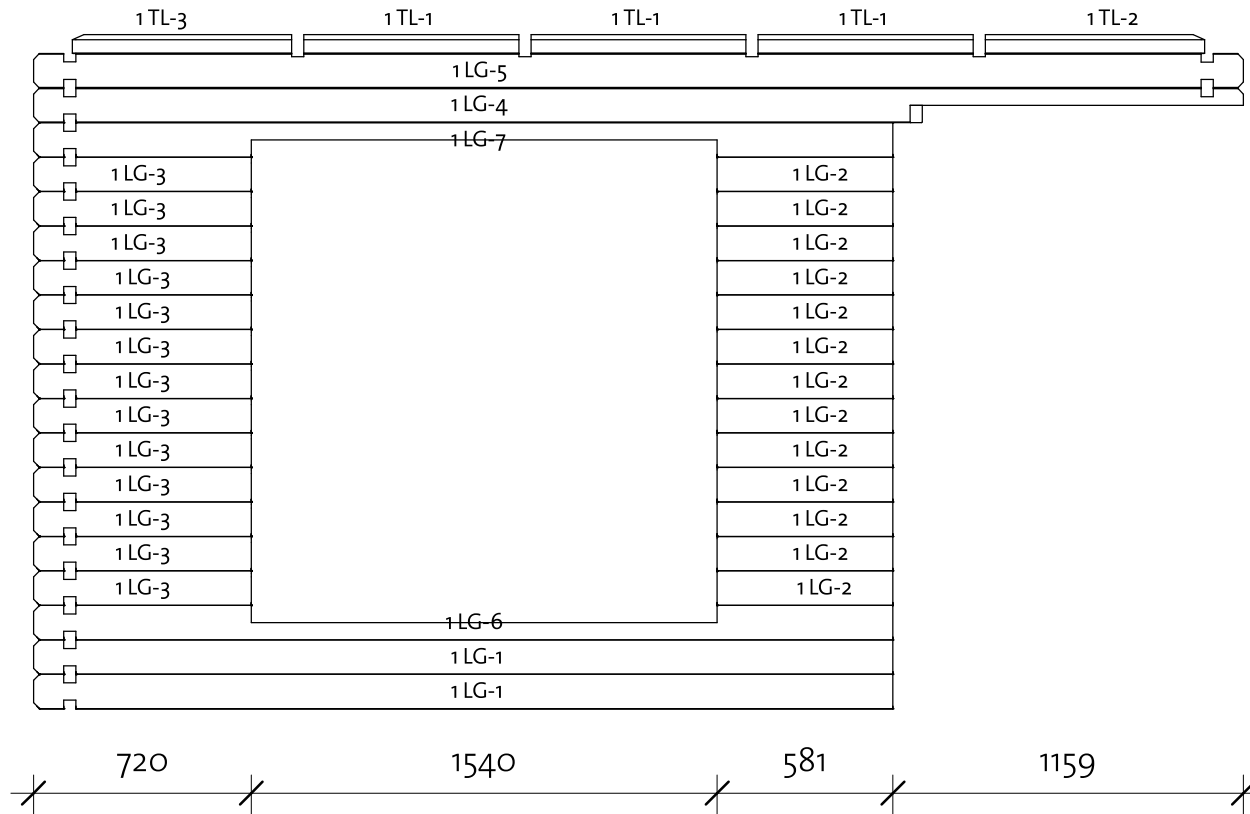

Log Profile Wall 1	
Profile	Profile

40x114	
40x114	
40x63	

# Victoria C 40 (380x380)

Wall 2

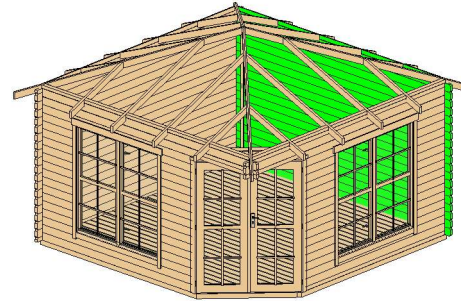

Wall 2			
Mark	Profile	Count	Cut Length

2LG-1	40x114	18	4000
2LG-2	40x114	1	4000
2TL-1	40x63	3	711
2TL-2	40x63	1	725
2TL-3	40x63	1	725

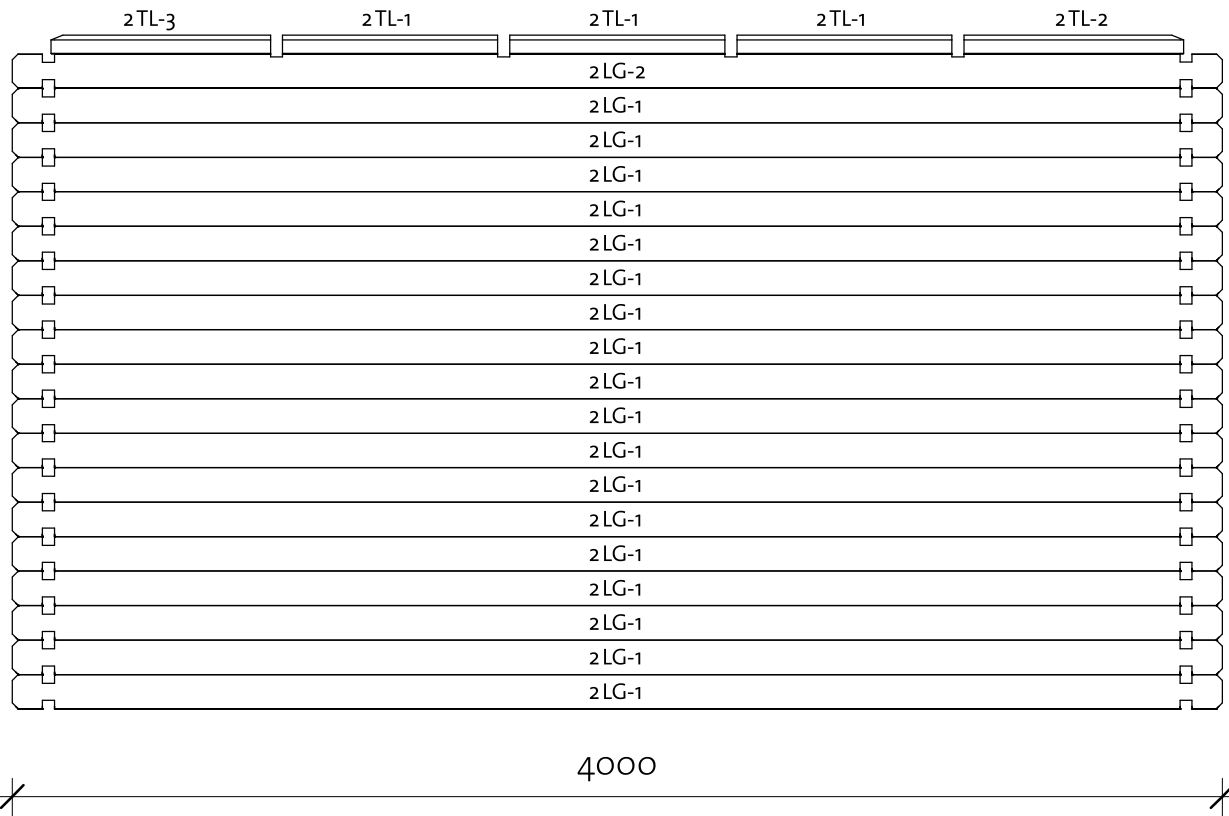

Log Profile Wall 2	
Profile	Profile

40x114	
40x114	
40x63	



# Victoria C 40 (380x380)

Wall B

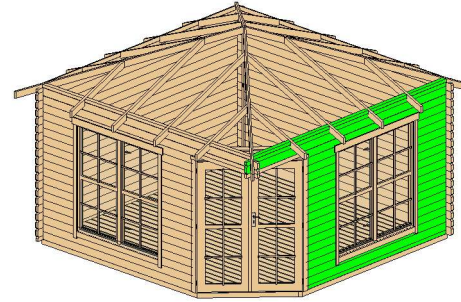

Wall B			
Mark	Profile	Count	Cut Length

BTL-1	40x63	3	711
BTL-2	40x63	1	725
BTL-3	40x63	1	725
BBL-1	40x57	1	2841
BLG-1	40x114	14	581
BLG-2	40x114	2	2841
BLG-3	40x114	1	2938
BLG-4	40x114	14	720
BLG-6	40x114	1	4000
BTL-4	40x114	1	4000

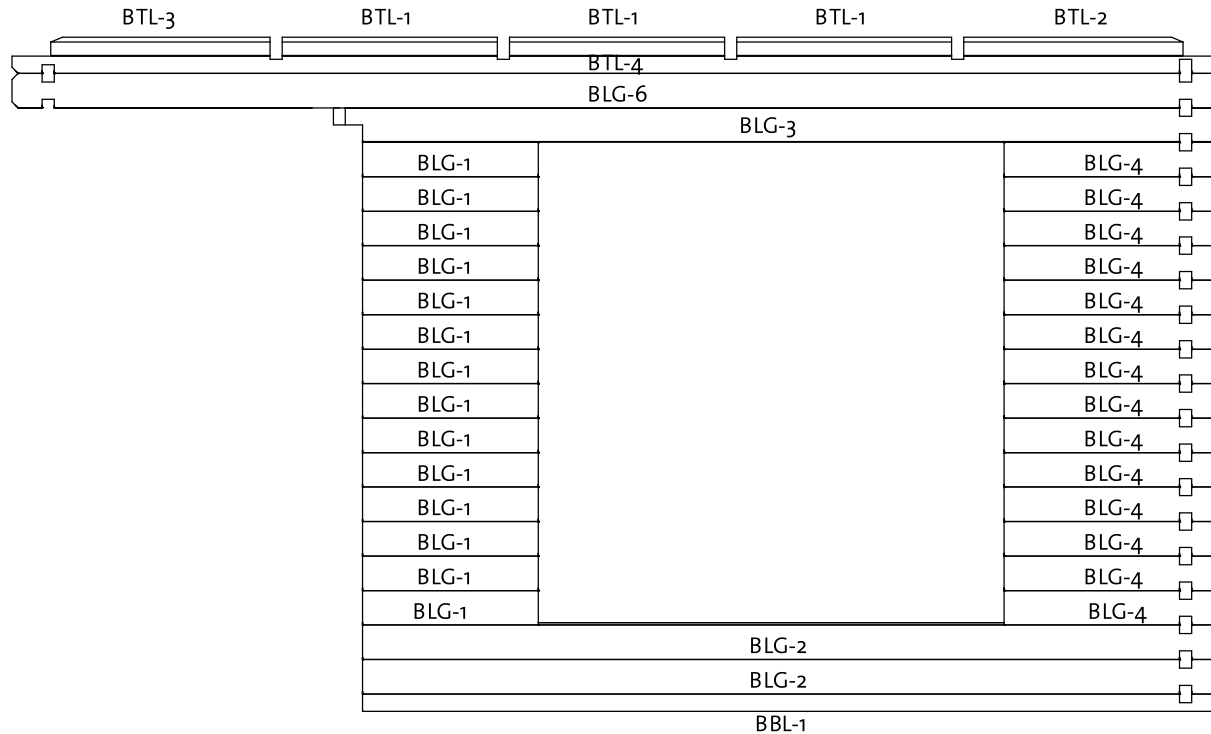

Log Profile Wall B	
Profile	Profile

40x57	
40x57 TL	

Log Profile Wall B	
Profile	Profile

40x63	
40x114	

# Victoria C 40 (380x380)

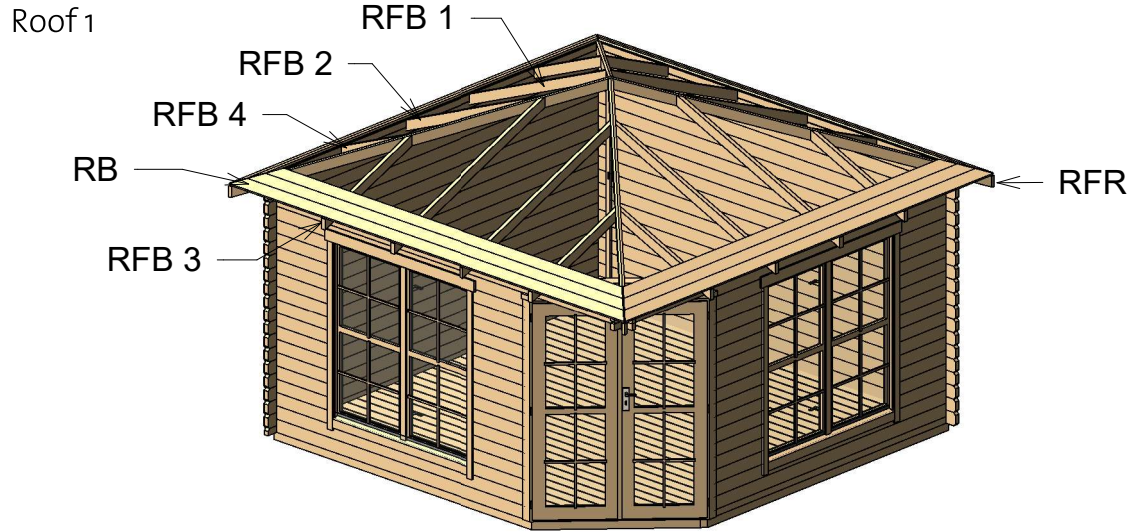

Roof				
Mark	Type	Profile	Count	Length

RFR	40x94		4	3172
RFB4	40x85		4	1132
RFB3	40x85		4	1132
RFB2	40x85		4	1945
RFB1	40x85		4	1945

Roofboards				
Mark	Type	Profile	Count	Length

RB 1	RoofBoard 18x110		4	217
RB 2	RoofBoard 18x110		4	421
RB 3	RoofBoard 18x110		4	624
RB 4	RoofBoard 18x110		4	827
RB 5	RoofBoard 18x110		4	1030
RB 6	RoofBoard 18x110		4	1234
RB 7	RoofBoard 18x110		4	1437
RB 8	RoofBoard 18x110		4	1640
RB 9	RoofBoard 18x110		4	1843

Roofboards				
Mark	Type	Profile	Count	Length

RB 10	RoofBoard 18x110		4	2047
RB 11	RoofBoard 18x110		4	2250
RB 12	RoofBoard 18x110		4	2453
RB 13	RoofBoard 18x110		4	2657
RB 14	RoofBoard 18x110		4	2860
RB 15	RoofBoard 18x110		4	3063
RB 16	RoofBoard 18x110		4	3266
RB 17	RoofBoard 18x110		4	3470
RB 18	RoofBoard 18x110		4	3673
RB 19	RoofBoard 18x110		4	3876
RB 20	RoofBoard 18x110		4	4079
RB 21	RoofBoard 18x110		4	4283



# Victoria C 40 (380x380)

Roof 2

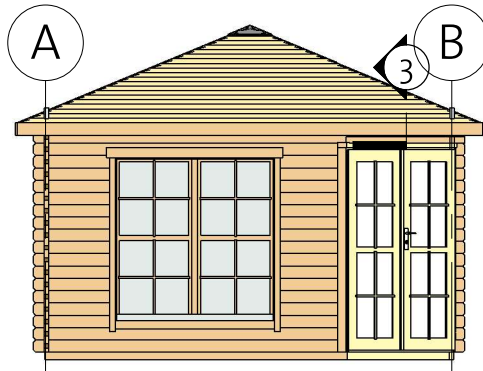

Fascia Schedule				
Mark	Type	Profile	Count	Length

RF	Roof Fascia 18x120		4	4314
----	-----------------------	-------------------------------------------------------------------------------------	---	------

3 Facia

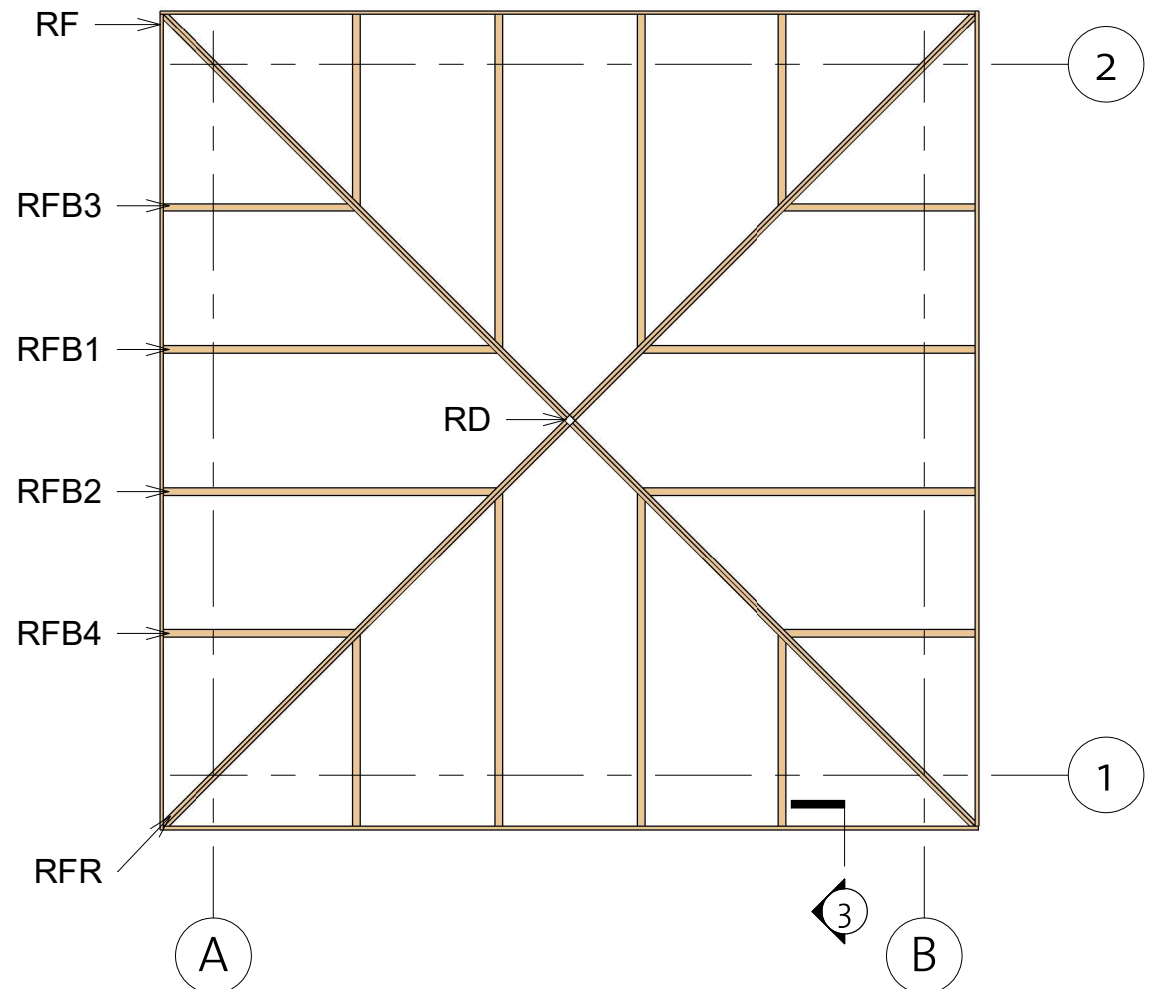
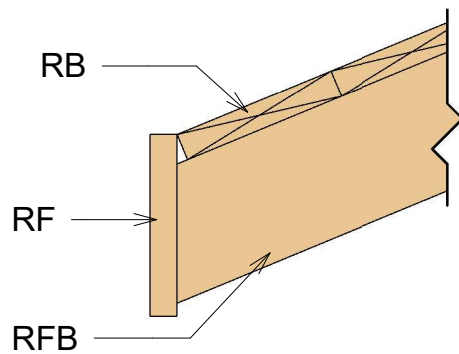

# Victoria C 40 (380x380)

Extras

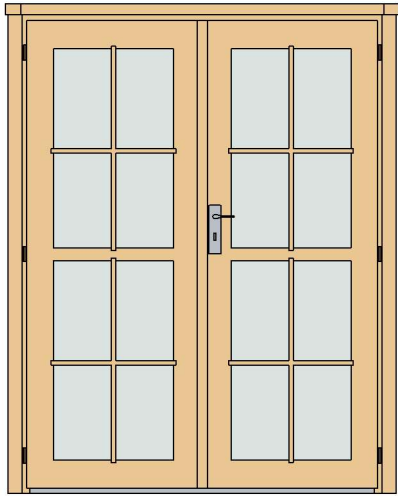

Door Schedule				
Model	Type	Width	Height	Count
CDD6R	Classic double door 6, two glass right	1425	1900	1

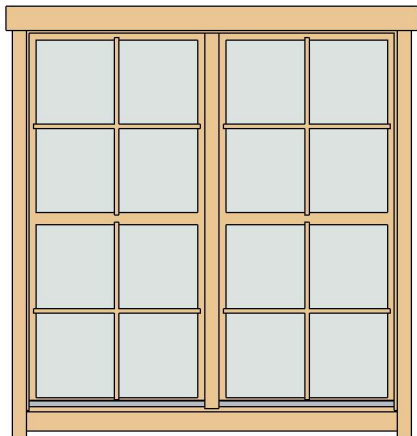

Window Schedule				
Model	Type	Width	Height	Count
CDW2	Classic double window 2	1530	1555	2



Type	Count	Length
Windboard 18x40	5	2200

Roof Dettail		
Mark	Type	Count
RD	Roof detail	1



Fasteners/Extras		
Name	Type	Count

Hitblock	300-400 mm	
Bolts	M8 x 70	15
Nails	1,4 x 40	40
Screws	5,0 x 70	60
Screws	4,0 x 40	65
Screws	6,0 x 140	110
Screws	4,0 x 50	850

① Roof top

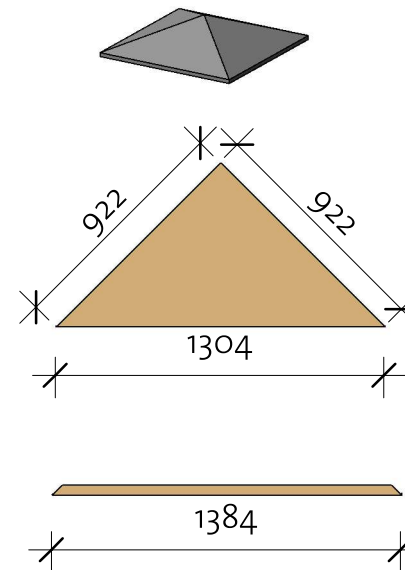

Type	Mark	Count
------	------	-------

Ceiling detail 40x120	CD	1
Ceiling triangle	CT	1

# Victoria C 40 (380x380)

## List of all items 1

### Impregnated foundation beams

Mark	Type	Profile	Count	Length
IFB1	IFB 40x70		6	3750
IFB2	IFB 40x70		1	3224
IFB3	IFB 40x70		1	2845
IFB4	IFB 40x70		1	2805
IFB5	IFB 40x70		2	1376

### Floor Schedule

Mark	Type	Profile	Count	Length
FB 1	FB 18x110		1	2857
FB 2	FB 18x110		1	2967
FB 3	FB 18x110		1	3077
FB 4	FB 18x110		1	3187
FB 5	FB 18x110		1	3297
FB 6	FB 18x110		1	3407
FB 7	FB 18x110		1	3517
FB 8	FB 18x110		1	3627
FB 9	FB 18x110		1	3717
FB 10	FB 18x110		26	3717

BB	BB 20x40		4	3800
----	-------------	---------------------------------------------------------------------------------------	---	------

# Victoria C 40 (380x380)

## List of all items 2

Wall 1			
Mark	Profile	Count	Cut Length

1LG-1	40x114	2	2841
1LG-2	40x114	13	581
1LG-3	40x114	13	720
1LG-4	40x114	1	4000
1LG-5	40x114	1	4000
1LG-6	40x114	1	2841
1LG-7	40x114	1	2841
1TL-1	40x63	3	711
1TL-2	40x63	1	725
1TL-3	40x63	1	725

Wall A			
Mark	Profile	Count	Cut Length

ATL-1	40x63	3	711
ATL-2	40x63	1	725
ATL-3	40x63	1	725
ABL-1	40x57	1	4000
ALG-1	40x114	18	4000
ATL-4	40x57 TL	1	4000

Log Profiles	
Profile	Profile

40x114	
--------	-------------------------------------------------------------------------------------



Wall 2			
Mark	Profile	Count	Cut Length

2LG-1	40x114	18	4000
2LG-2	40x114	1	4000
2TL-1	40x63	3	711
2TL-2	40x63	1	725
2TL-3	40x63	1	725

Wall B			
Mark	Profile	Count	Cut Length



BTL-1	40x63	3	711
BTL-2	40x63	1	725
BTL-3	40x63	1	725
BBL-1	40x57	1	2841
BLG-1	40x114	14	581
BLG-2	40x114	2	2841
BLG-3	40x114	1	2938
BLG-4	40x114	14	720
BLG-6	40x114	1	4000
BTL-4	40x114	1	4000

Log Profiles	
Profile	Profile

40x63	
40x114	
40x57 TL	

# Victoria C 40 (380x380)

## List of all items 3

Roof				
Mark	Type	Profile	Count	Length
RFR	40x94		4	3172
RFB4	40x85		4	1132
RFB3	40x85		4	1132
RFB2	40x85		4	1945
RFB1	40x85		4	1945

Roofboards				
Mark	Type	Profile	Count	Length
RB 1	RoofBoard 18x110		4	217
RB 2	RoofBoard 18x110		4	421
RB 3	RoofBoard 18x110		4	624
RB 4	RoofBoard 18x110		4	827
RB 5	RoofBoard 18x110		4	1030
RB 6	RoofBoard 18x110		4	1234
RB 7	RoofBoard 18x110		4	1437
RB 8	RoofBoard 18x110		4	1640
RB 9	RoofBoard 18x110		4	1843

Roofboards				
Mark	Type	Profile	Count	Length
RB 10	RoofBoard 18x110		4	2047
RB 11	RoofBoard 18x110		4	2250
RB 12	RoofBoard 18x110		4	2453
RB 13	RoofBoard 18x110		4	2657
RB 14	RoofBoard 18x110		4	2860
RB 15	RoofBoard 18x110		4	3063
RB 16	RoofBoard 18x110		4	3266
RB 17	RoofBoard 18x110		4	3470
RB 18	RoofBoard 18x110		4	3673
RB 19	RoofBoard 18x110		4	3876
RB 20	RoofBoard 18x110		4	4079
RB 21	RoofBoard 18x110		4	4283

Fascia Schedule				
Mark	Type	Profile	Count	Length
RF	Roof Fascia 18x120		4	4314