

Gnesta 40 (350x425)

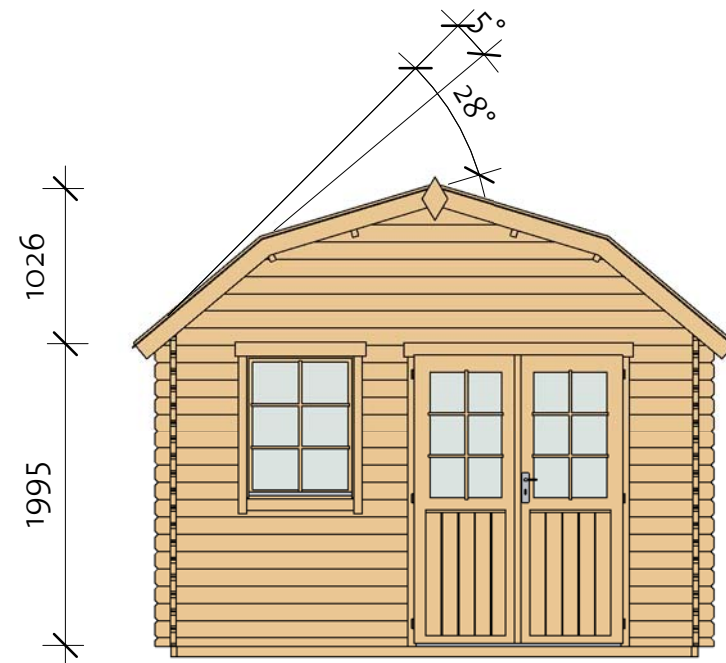

Gnesta 40 (350x425)

Foundation

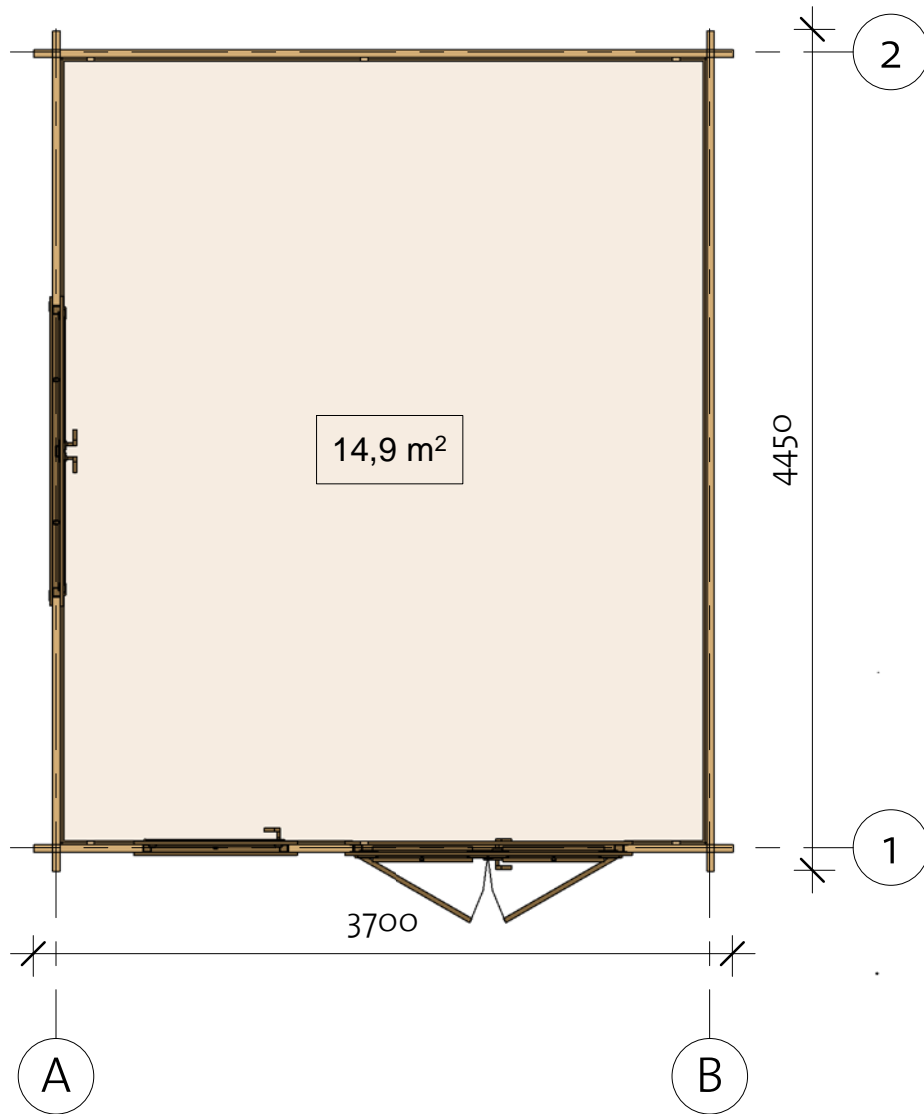
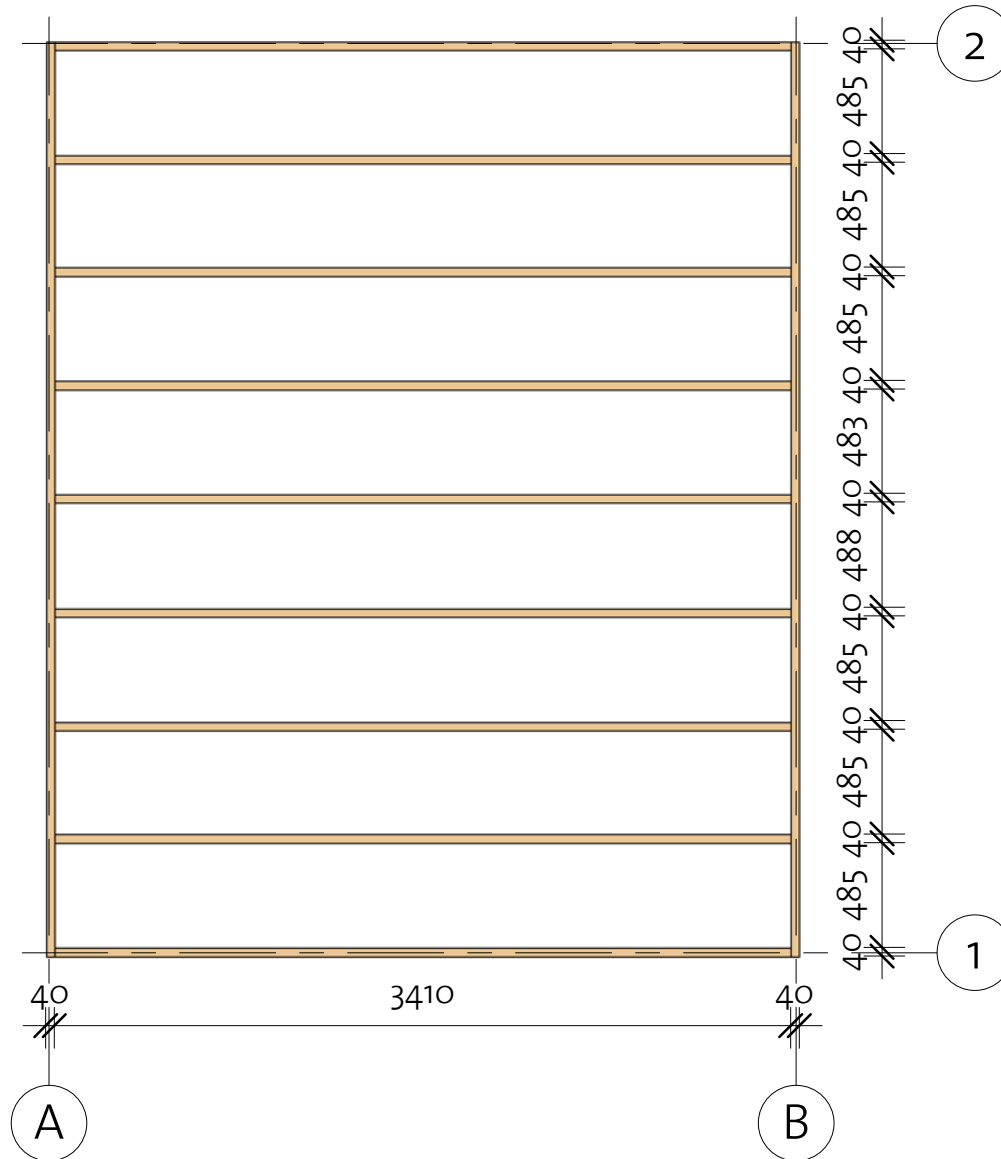

Impregnated foundation beams				
Mark	Type	Profile	Count	Length

IFB1	IFB 40x70		2	4240
IFB2	IFB 40x70		9	3410



Gnesta 40 (350x425)

Floor Plan

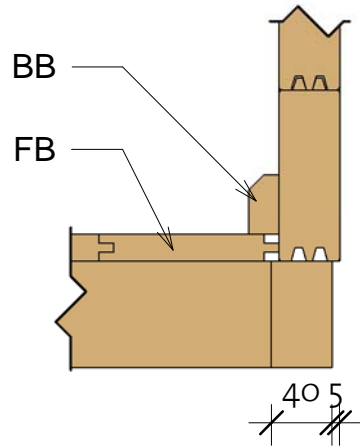
① Baseboard



Floor Schedule

Mark	Type	Profile	Count	Length
FB	FB 18x110		32	4166
BB	BB 20x40		2	3500
BB	BB 20x40		2	4250

4200011_190304

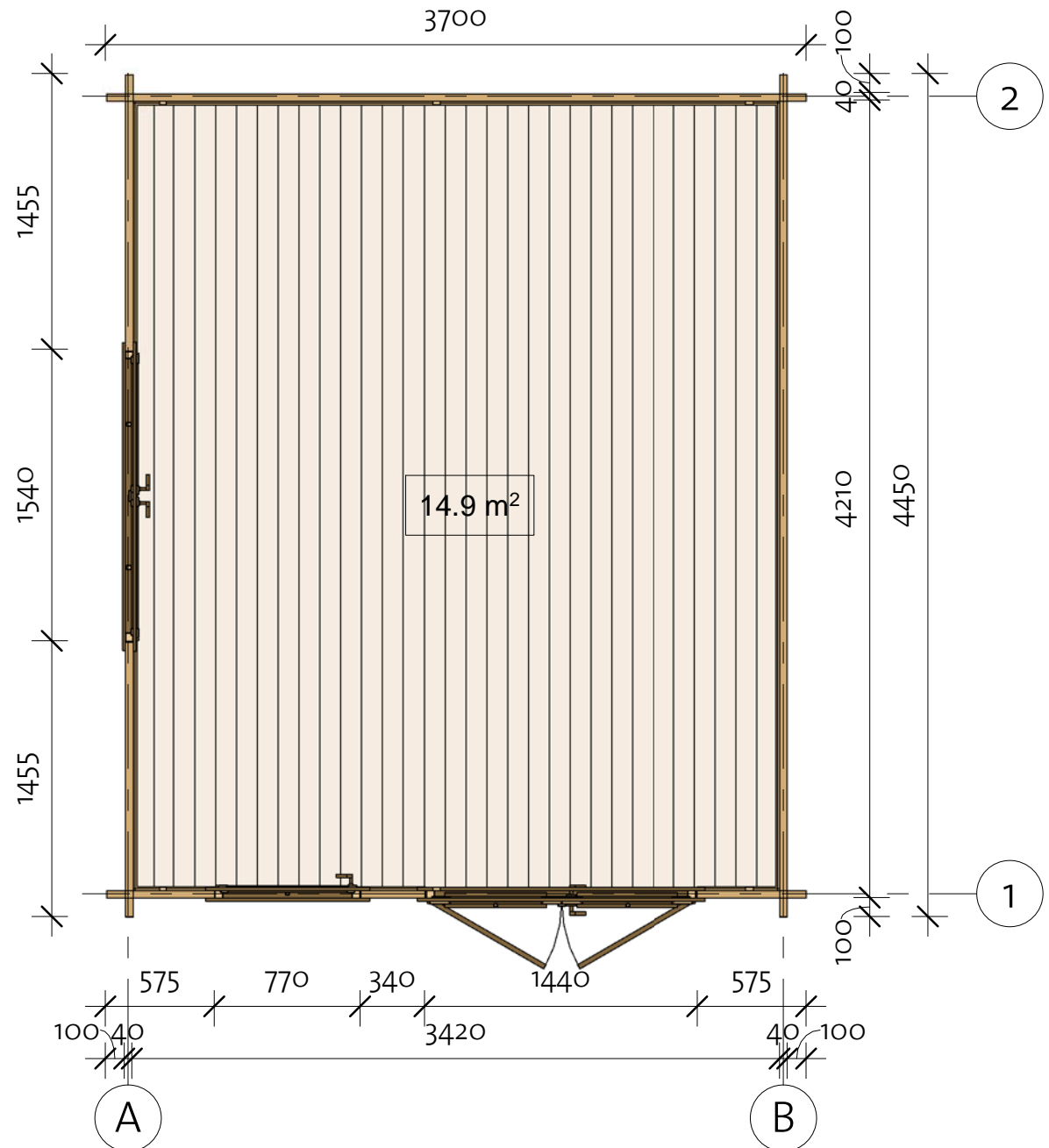

Gnesta 40 (350x425)

Wall 1

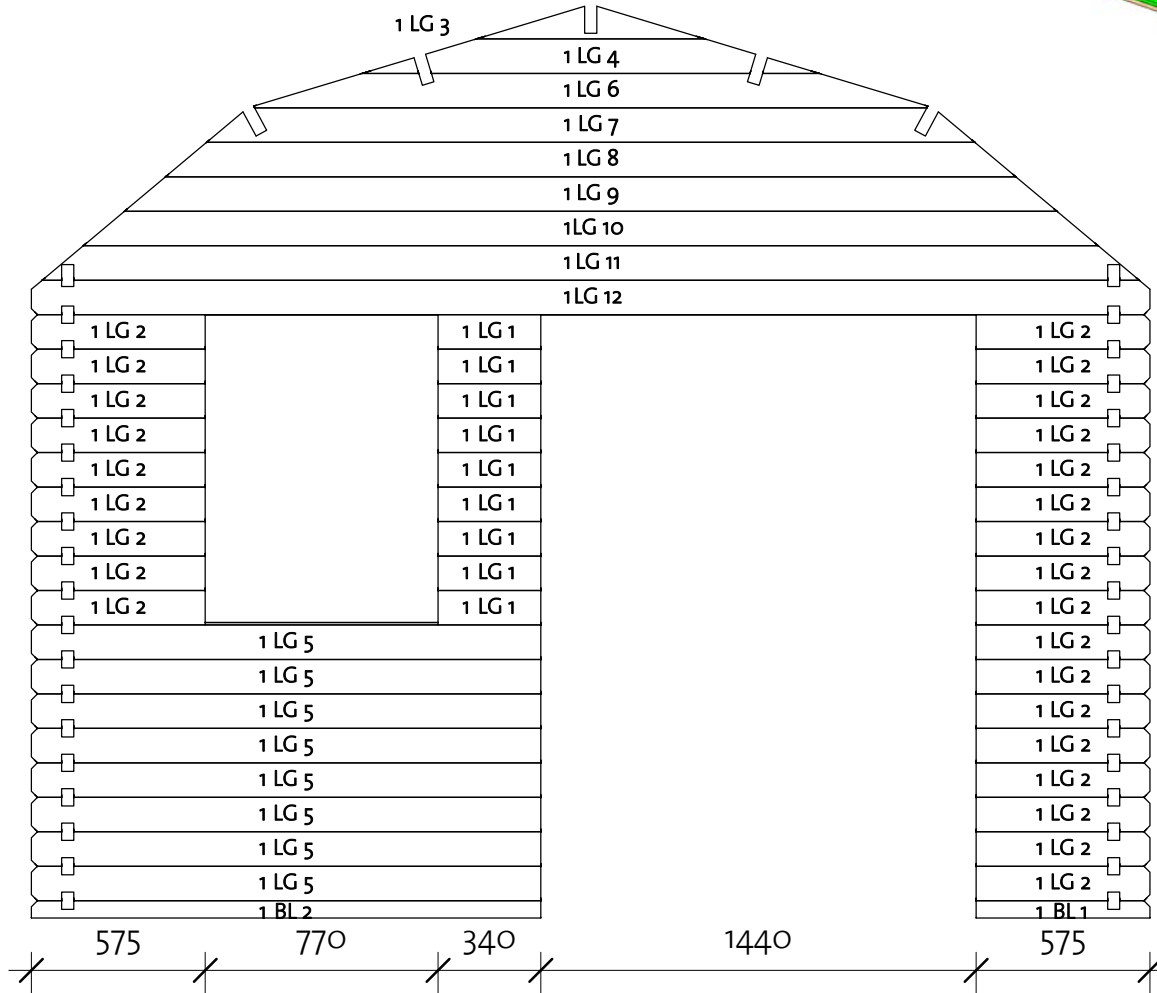
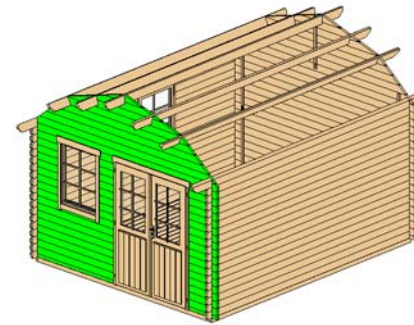

*Gable 1 - delivered premounted

**Gable 2 - delivered premounted

Wall 1			
Mark	Profile	Count	Cut Length

1BL 1	40X57	1	575
1BL 2	40X57	1	1685
1LG 1	40X114	9	340
1LG 2	40X114	26	575
1LG 3*	40X114	1	757
1LG 4*	40X114	1	1513
1LG 5	40X114	8	1685
1LG 6*	40X114	1	2230
1LG 7*	40X114	1	2541
1LG 8**	40X114	1	2813
1LG 9**	40X114	1	3085
1LG 10**	40X114	1	3357
1LG 11**	40X114	1	3629
1LG 12	40X114	1	3700

Log Profile Wall 1	
Profile	Profile

40X57	
40X114	

Gnesta 40 (350x425)

Wall 2

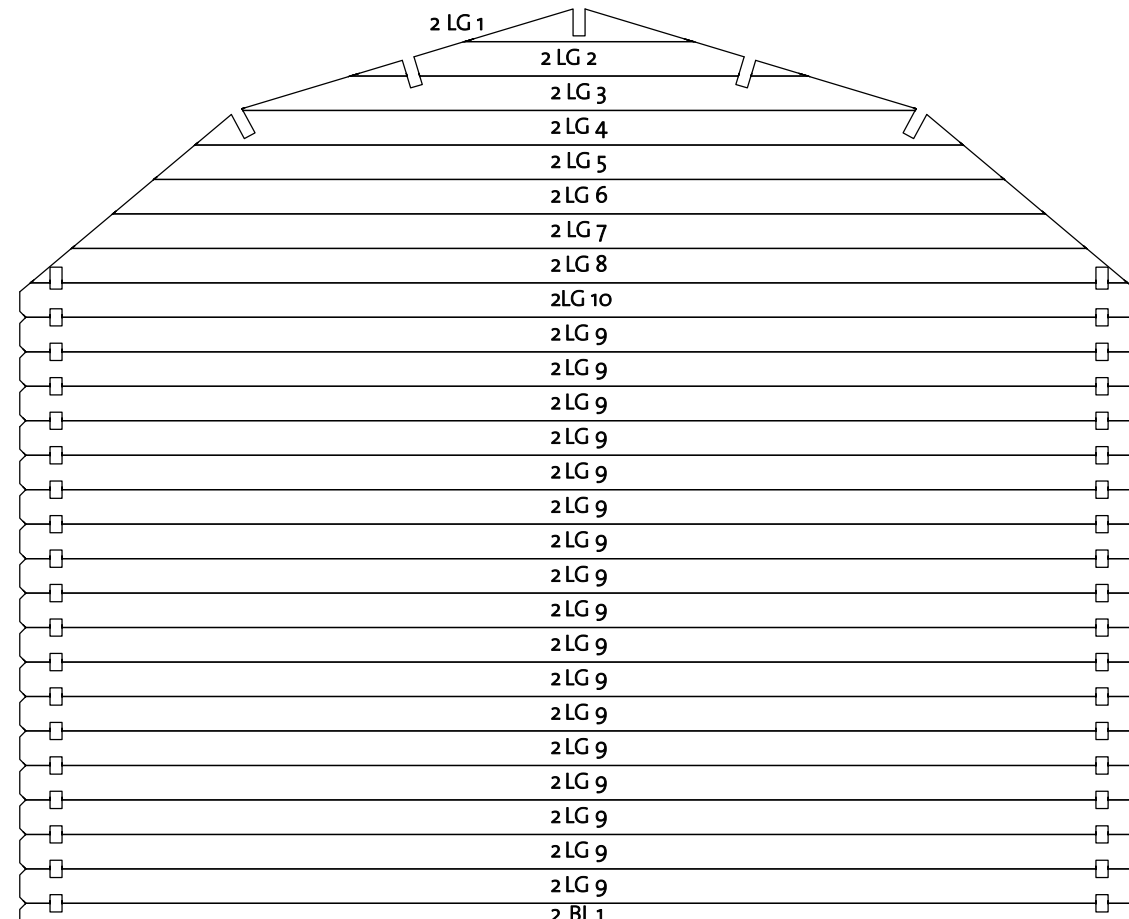
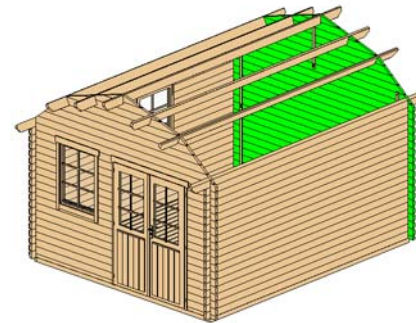

3700

*Gable 1 - delivered premounted

**Gable 2 - delivered premounted

Wall 2			
Mark	Profile	Count	Cut Length

2BL 1	40X57	1	3700
2LG 1 *	40X114	1	757
2LG 2 *	40X114	1	1513
2LG 3 *	40X114	1	2230
2LG 4 *	40X114	1	2541
2LG 5 **	40X114	1	2813
2LG 6 **	40X114	1	3085
2LG 7 **	40X114	1	3357
2LG 8 **	40X114	1	3629
2LG 9	40X114	17	3700
2LG 10	40X114	1	3700

Log Profile Wall 2

Profile	Profile
---------	---------

40X57



40X114



Gnesta 40 (350x425)

Wall A

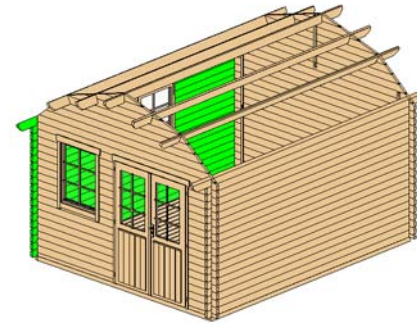

Wall A			
Mark	Profile	Count	Cut Length

ALG 1	40x114	18	1455
ALG 2	40x114	9	4450
ATL 1	40x145	1	5050

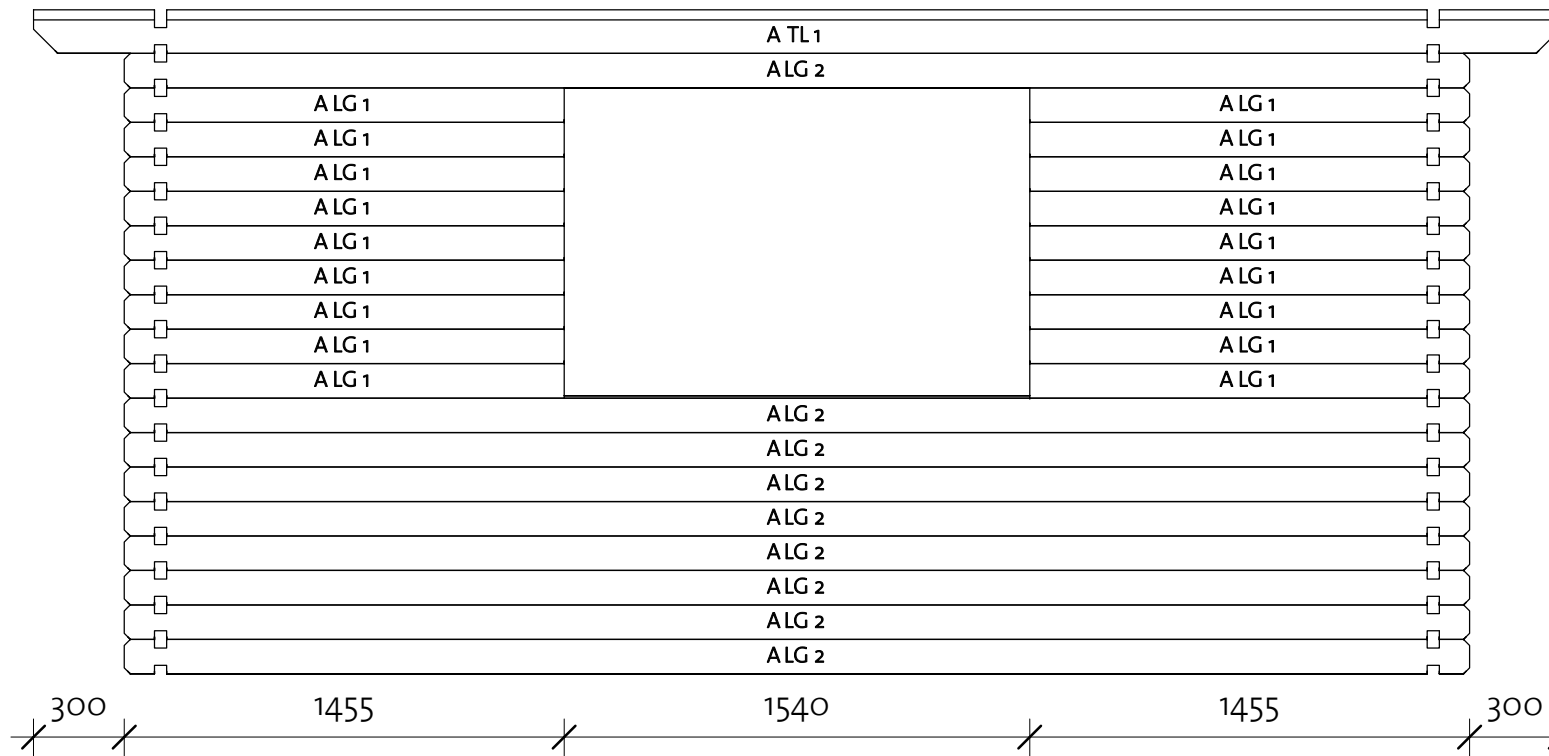

Log Profile Wall A	
Profile	Profile

40x114	
40x145	

Gnesta 40 (350x425)

Wall B

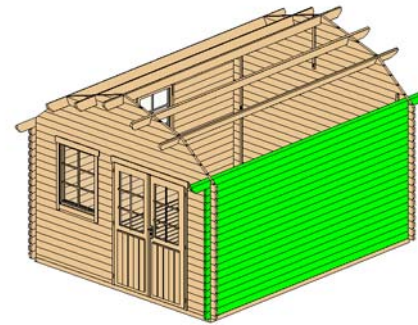

Wall B			
Mark	Profile	Count	Cut Length

BLG 1	40x114	18	4450
BTL 1	40x145	1	5050

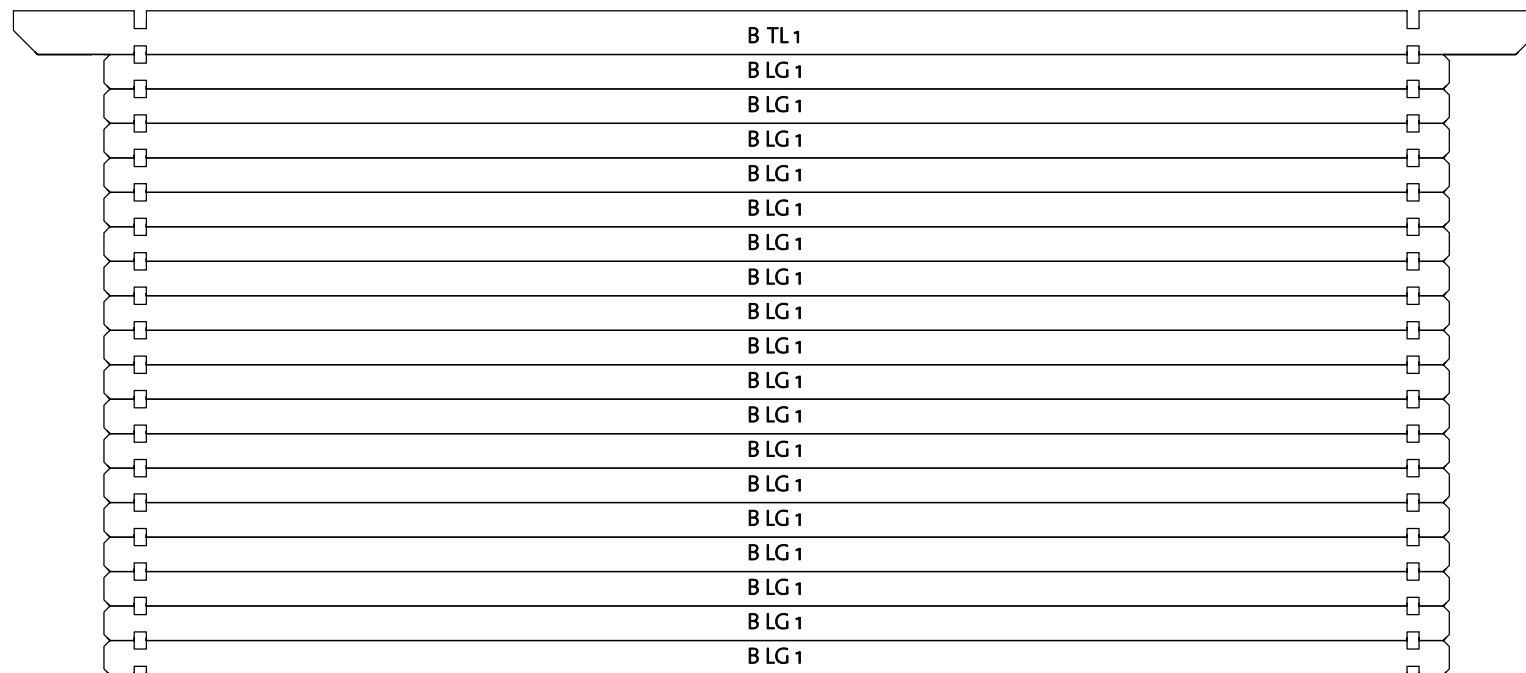

Log Profile Wall B	
Profile	Profile

40x114	
40x145	



4200011_190304

Gnesta 40 (350x425)

Roof 1

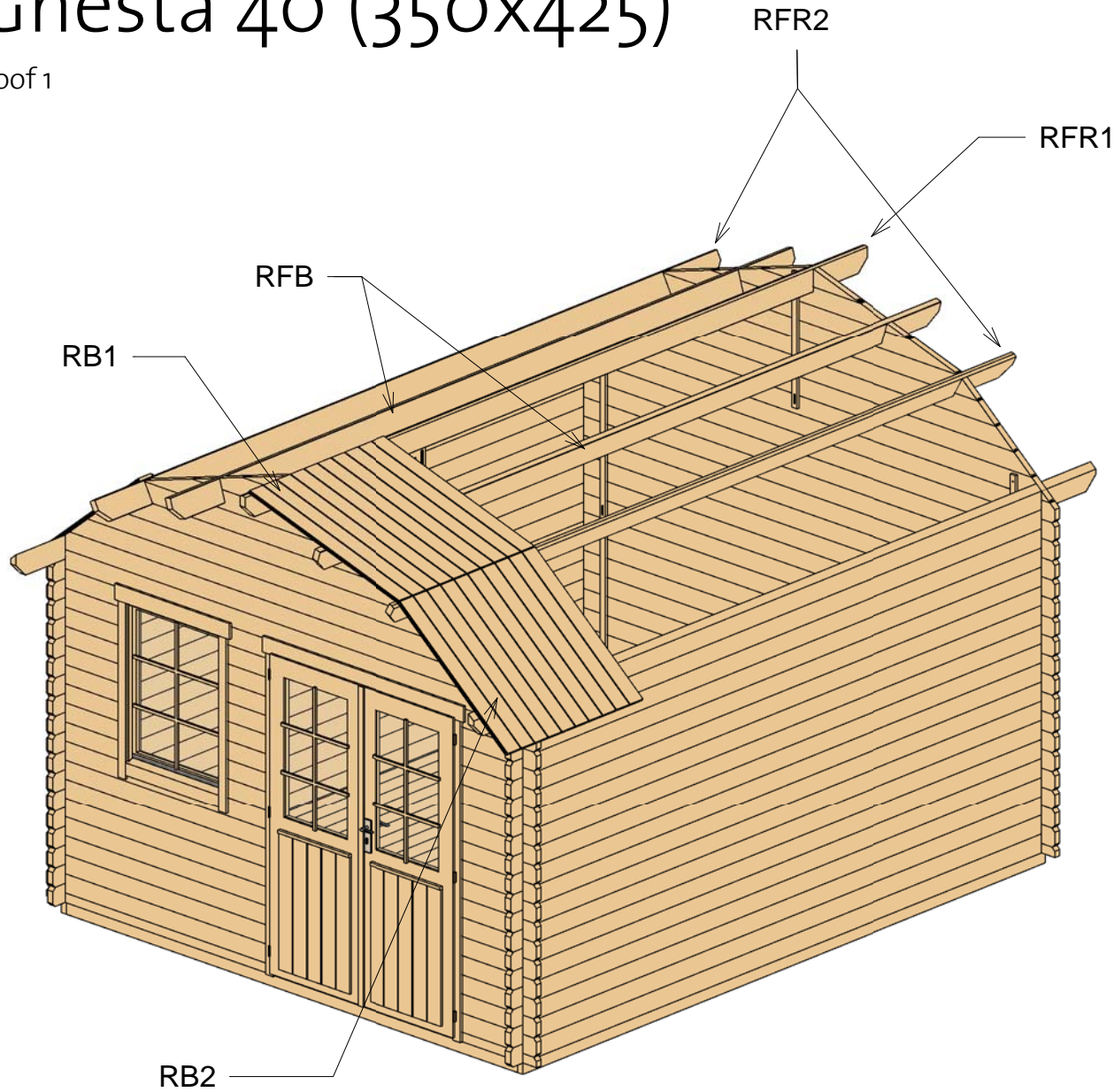

Roof				
Mark	Type	Profile	Count	Length
RFR1	Ridge 40x143		1	5050
RFR2	Ridge 40x143		2	5050
RFB	Beam 40x143		2	5050
RB1	RoofBoard 18x110		94	1185
RB2	RoofBoard 18x110		94	1060

Gnesta 40 (350x425)

List of all items 2



Wall 1			
Mark	Profile	Count	Cut Length

1BL 1	40X57	1	575
1BL 2	40X57	1	1685
1LG 1	40X114	9	340
1LG 2	40X114	26	575
1LG 3*	40X114	1	757
1LG 4*	40X114	1	1513
1LG 5	40X114	8	1685
1LG 6*	40X114	1	2230
1LG 7*	40X114	1	2541
1LG 8**	40X114	1	2813
1LG 9**	40X114	1	3085
1LG 10**	40X114	1	3357
1LG 11**	40X114	1	3629
1LG 12	40X114	1	3700

Wall A			
Mark	Profile	Count	Cut Length

ALG 1	40X114	18	1455
ALG 2	40X114	9	4450
ATL 1	40X145	1	5050

Log Profiles	
Profile	Profile

40X57	
40X114	

Wall 2			
Mark	Profile	Count	Cut Length

2BL 1	40X57	1	3700
2LG 1*	40X114	1	757
2LG 2*	40X114	1	1513
2LG 3*	40X114	1	2230
2LG 4*	40X114	1	2541
2LG 5**	40X114	1	2813
2LG 6**	40X114	1	3085
2LG 7**	40X114	1	3357
2LG 8**	40X114	1	3629
2LG 9	40X114	17	3700
2LG 10	40X114	1	3700

Wall B			
Mark	Profile	Count	Cut Length

BLG 1	40X114	18	4450
BTL 1	40X145	1	5050

*Gable-delivered premounted

**Gable-delivered premounted

Log Profiles	
Profile	Profile

40X145	
--------	---

Gnesta 40 (350x425)

Roof 2

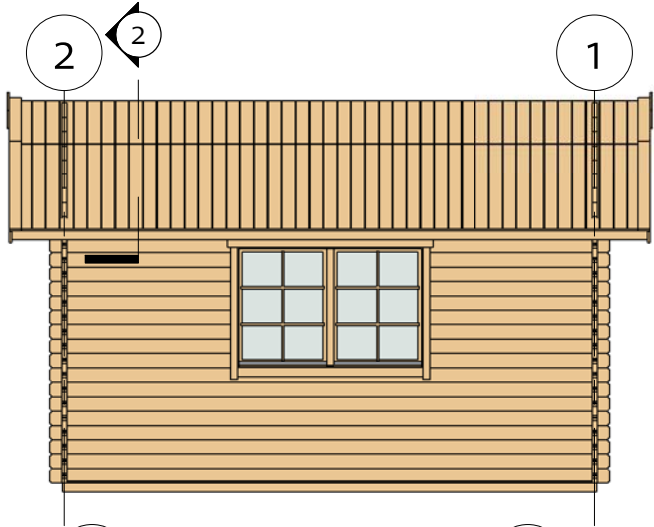

② Facia

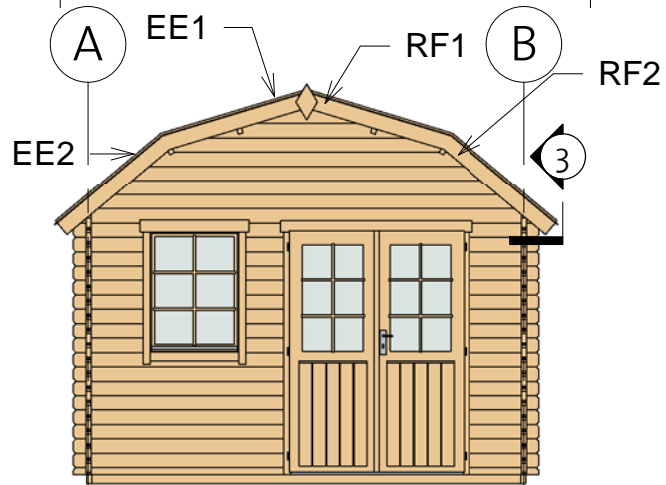
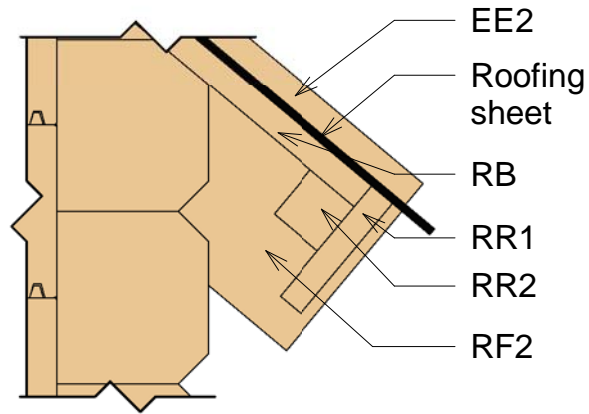

③ Roof Reinforcement

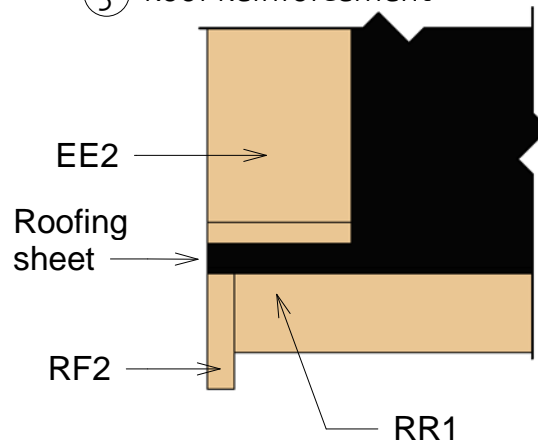

Fascia Schedule

Mark	Type	Profile	Count	Length
EE1	Eave Edging 18x95		4	1197
EE2	Eave Edging 18x95		4	1090
RF1	Roof Fascia 18x120		4	1194
RF2	Roof Fascia 18x120		4	1090
RR1	Roof reinforcement 18x95		2	5050
RR2	Roof reinforcement 38x38		2	5050

Gnesta 40 (350x425)

Extras



Door Schedule				
Model	Type	Width	Height	Count
CDD1R	Classic double door 1 right	1425	1955	1
DCB6	Door crossbar 6	--	--	2

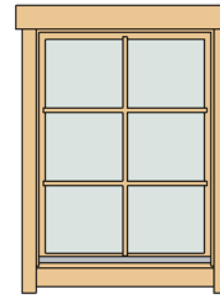

Window Schedule				
Model	Type	Width	Height	Count
CDW1	Classic double window 1	1530	990	1
CW1R	Classic window 1 right	765	990	1

WCB6	Window crossbar 6	--	--	3
------	-------------------	----	----	---

Fasteners/Extras		
Name	Type	Count

Hitblock	300-400 mm	
Screws	5,0 x 70	15
Bolts	M8 x 70	16
Nails	1,4 x 40	40
Screws	6,0 x 140	70
Screws	4,0 x 40	120
Screws	4,0 x 50	850

Type	Count	Length
Windboard 18x40	5	2200

Family	Count
--------	-------

Romb	2
------	---

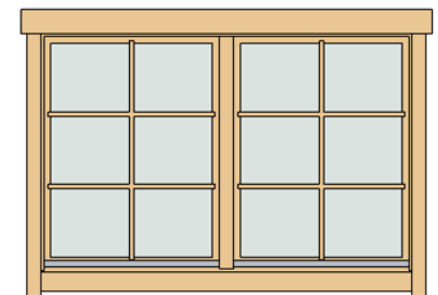



4200011_190821

Gnesta 40 (350x425)

List of all items 1

Impregnated foundation beams





Mark	Type	Profile	Count	Length
IFB1	IFB 40x70		2	4240
IFB2	IFB 40x70		9	3410

Floor Schedule

Mark	Type	Profile	Count	Length
FB	FB 18x110		32	4166
BB	BB 20x40		2	3500
BB	BB 20x40		2	4250







Roof

Mark	Type	Profile	Count	Length
------	------	---------	-------	--------

RFR1	Ridge 40x143		1	5050
RFR2	Ridge 40x143		2	5050
RFB	Beam 40x143		2	5050
RB1	RoofBoard 18x110		94	1185
RB2	RoofBoard 18x110		94	1060

Fascia Schedule

Mark	Type	Profile	Count	Length
------	------	---------	-------	--------

EE1	Eave Edging 18x95		4	1197
EE2	Eave Edging 18x95		4	1090
RF1	Roof Fascia 18x120		4	1194
RF2	Roof Fascia 18x120		4	1090
RR1	Roof reinforcement 18x95		2	5050
RR2	Roof reinforcement 38x38		2	5050