

# Montana 1 9/16" (149 5/8"x226 3/8")

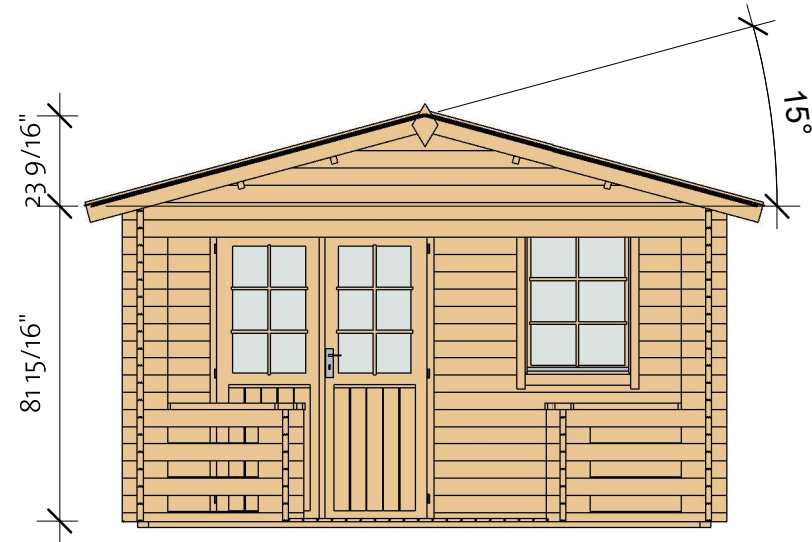

190513

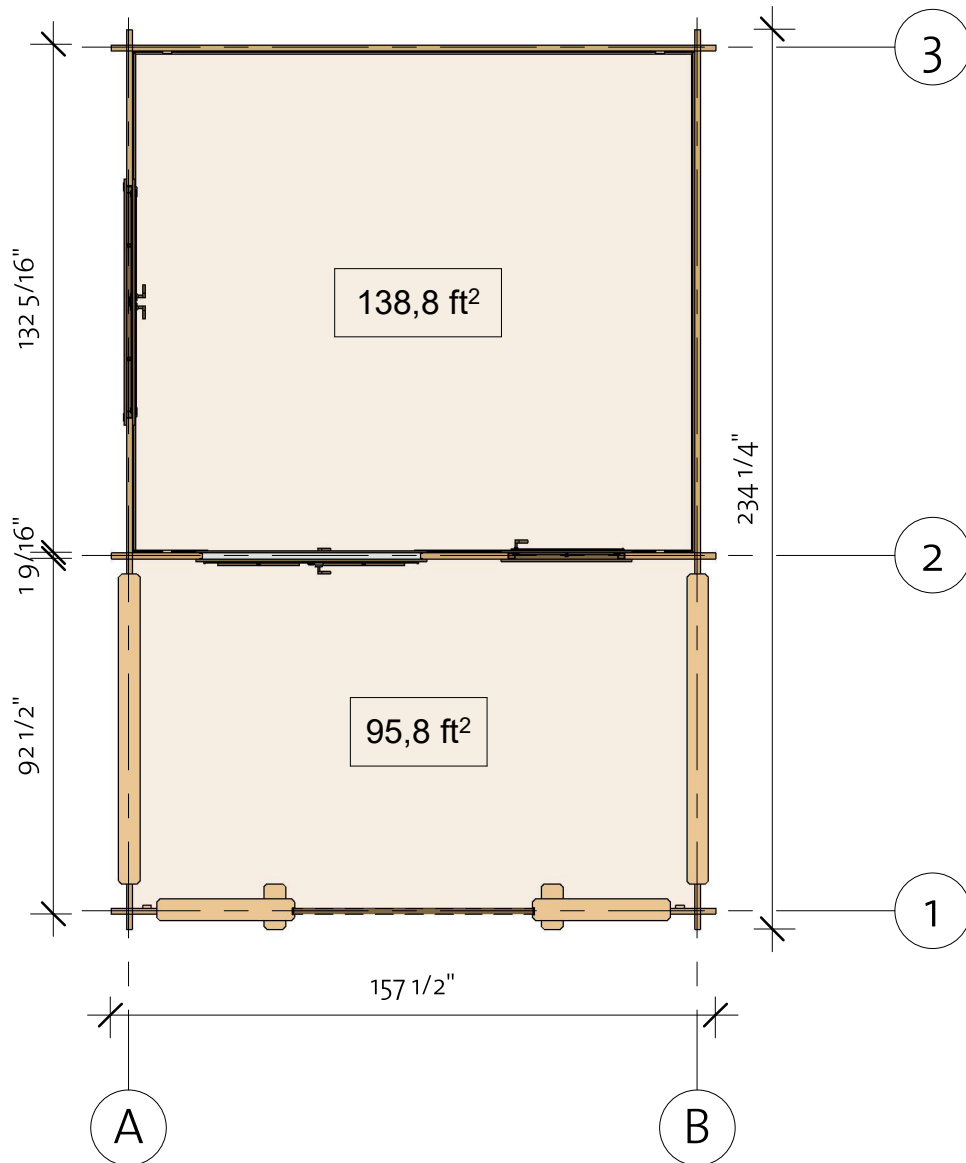

# Montana 1 9/16" (149 5/8"x226 3/8")

Floor Plan

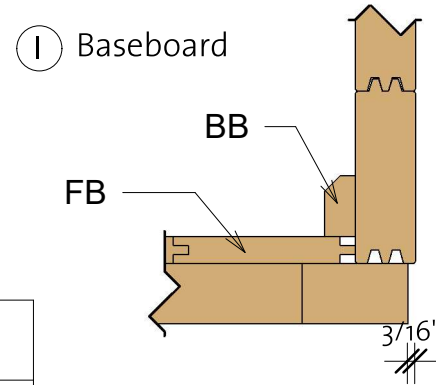

Floor Schedule				
Mark	Type	Profile	Count	Length

FB	FB 18x110		35	130 9/16"
TB1	TB 21x95		21	90 15/16"
TB2	TB 21x95		18	92 1/2"

BB1	BB 20x40		2	149 5/8"
BB2	BB 20x40		2	133 7/8"

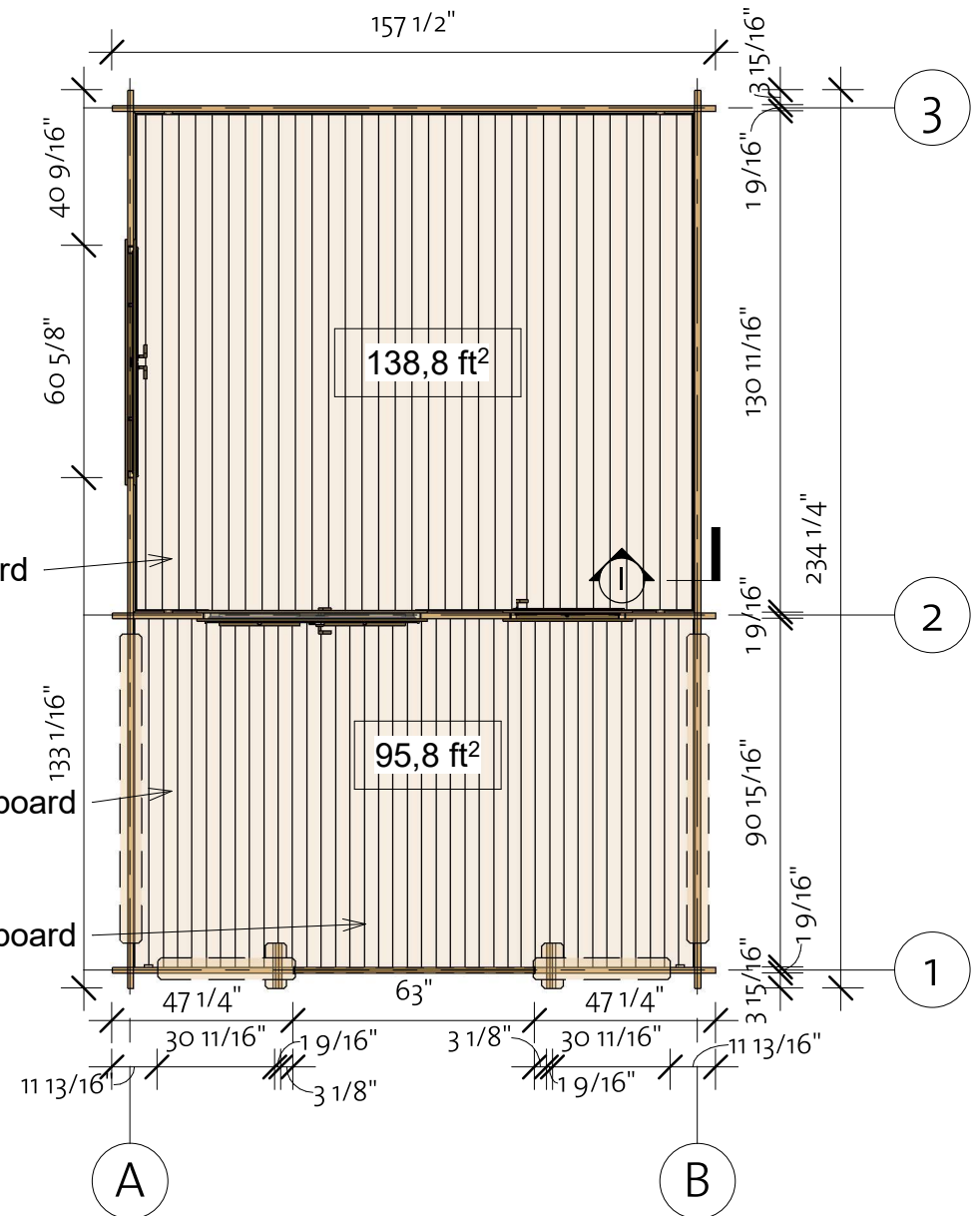

# Montana 1 9/16" (149 5/8"x226 3/8")

Wall 1

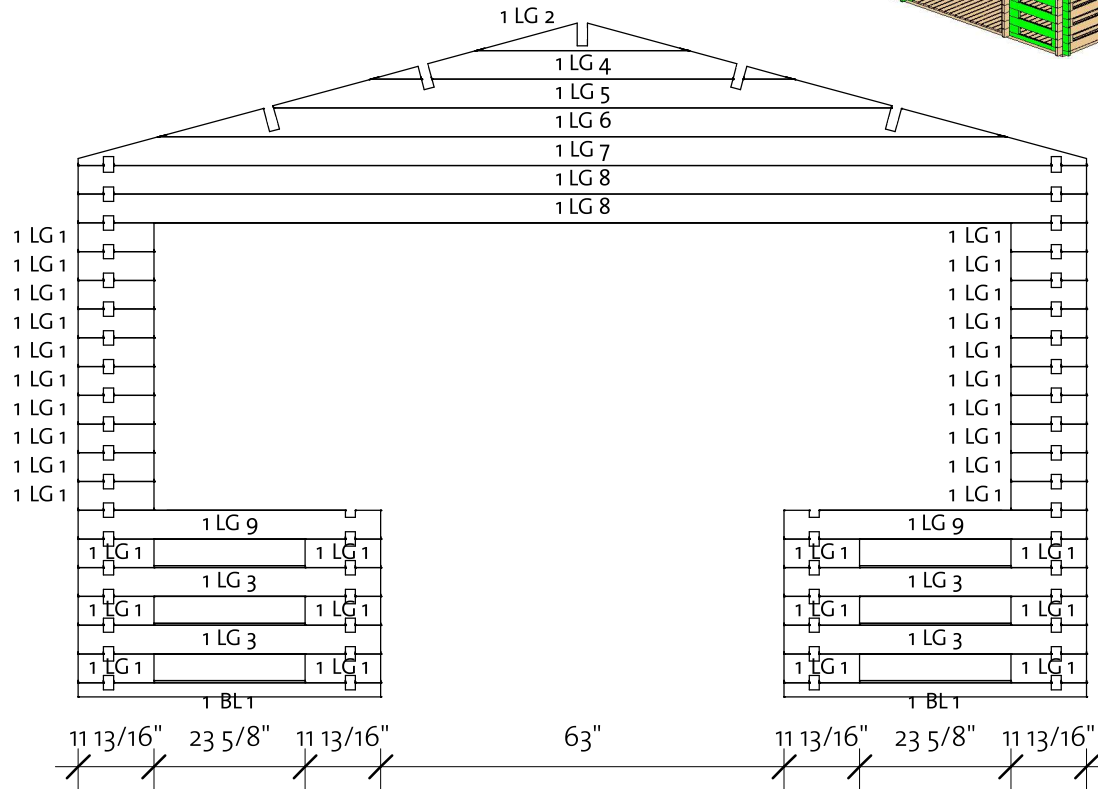
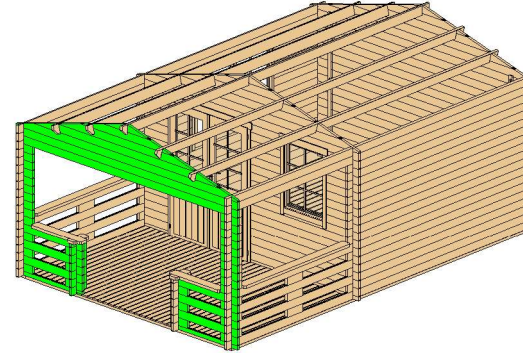



Wall 1			
Mark	Profile	Count	Cut Length

1BL 1	40X57	2	47 1/4"
1LG 1	40X114	32	11 13/16"
1LG 2*	40X114	1	33"
1LG 3	40X114	4	47 1/4"
1LG 4*	40X114	1	66 1/16"
1LG 5*	40X114	1	96 5/8"
1LG 6*	40X114	1	132 3/16"
1LG 7*	40X114	1	157 1/2"
1LG 8	40X114	2	157 1/2"
1LG 9	40X114	2	47 1/4"

\* Gable - delivered premounted

Log Profile Wall 1	
Profile	Profile

40X57	
40X114	



# Montana 1 9/16" (149 5/8"x226 3/8")

Wall 3

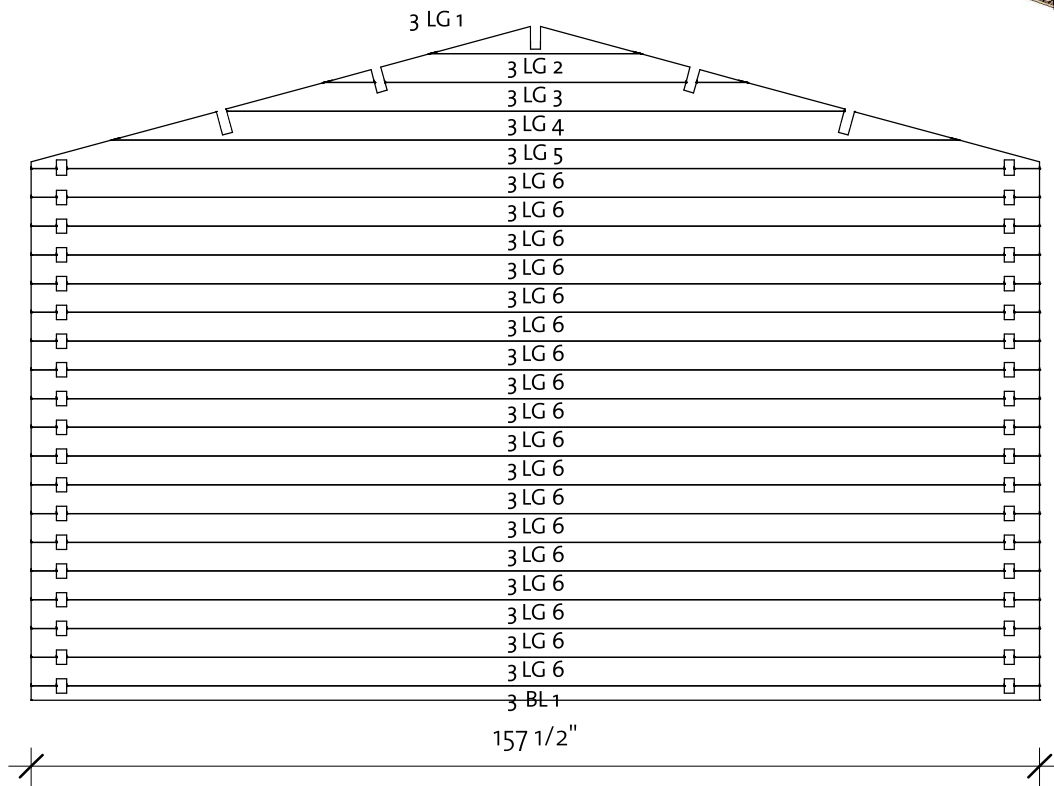
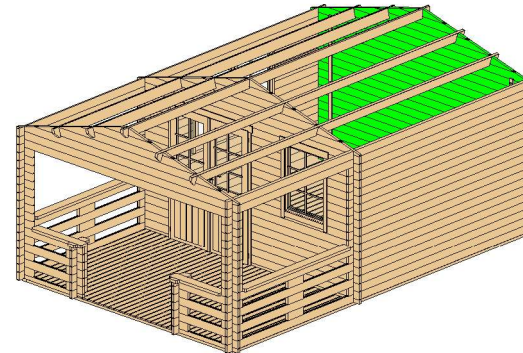

Wall 3			
Mark	Profile	Count	Cut Length

3BL 1	40x57	1	157 1/2"
3LG 1*	40x114	1	33"
3LG 2*	40x114	1	66 1/16"
3LG 3*	40x114	1	96 5/8"
3LG 4*	40x114	1	132 3/16"
3LG 5*	40x114	1	157 1/2"
3LG 6	40x114	18	157 1/2"

\* Gable - delivered premounted

Log Profile Wall 3	
Profile	Profile

40x57	
40x114	

# Montana 1 9/16" (149 5/8"x226 3/8")

Wall A

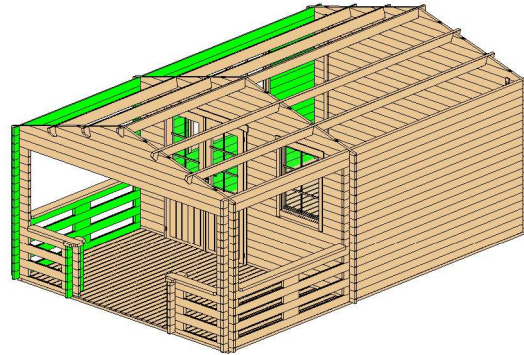

Wall AA			
Mark	Profile	Count	Cut Length

AALG 1	40x114	6	11 13/16"
AATL 1	40x57	1	11 13/16"

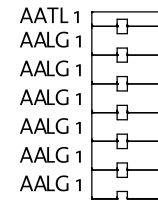

Wall A			
Mark	Profile	Count	Cut Length

ALG 1	40x114	13	11 13/16"
ALG 2	40x114	3	11 13/16"
ALG 3	40x114	18	40 9/16"
ALG 4	40x114	4	141 3/4"
ALG 5	40x114	4	234 1/4"
ALG 6	40x114	1	234 1/4"
ATL 1	40x122	1	234 1/4"

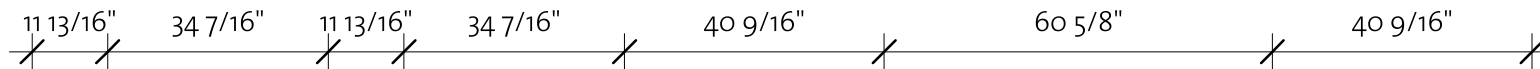
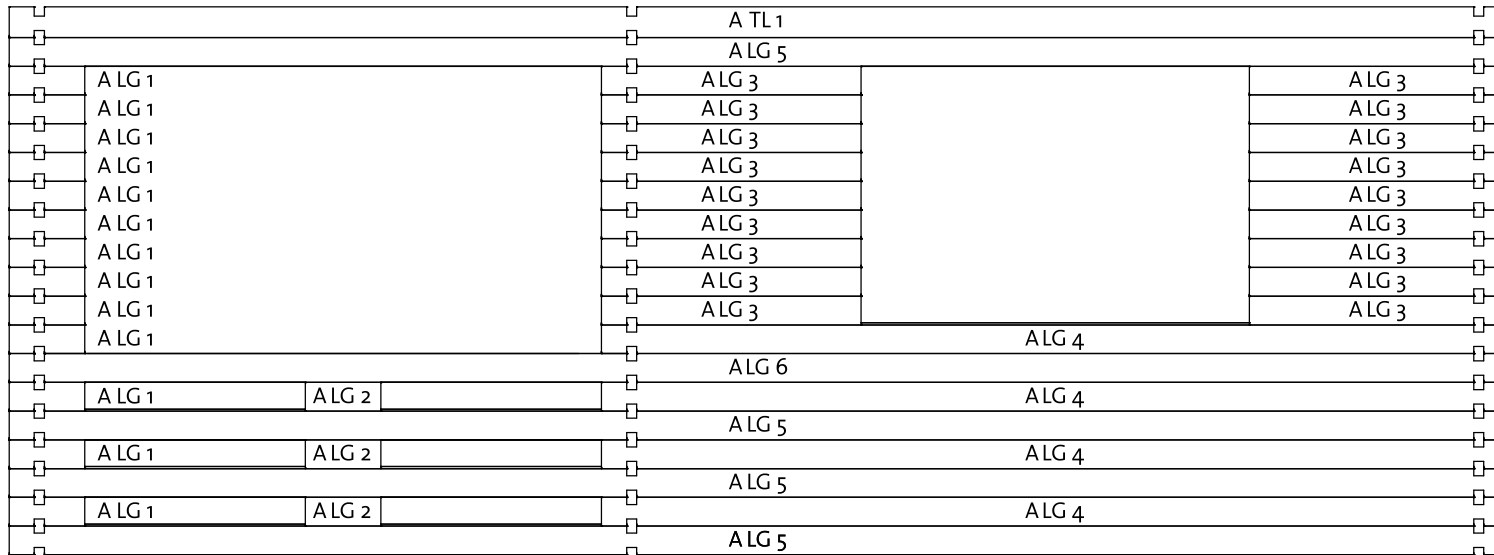

Log Profile Wall A	
Profile	Profile

40x57	
40x114	
40x122	

# Montana 1 9/16" (149 5/8"x226 3/8")

Wall B

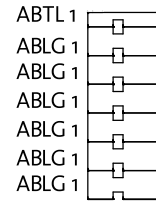
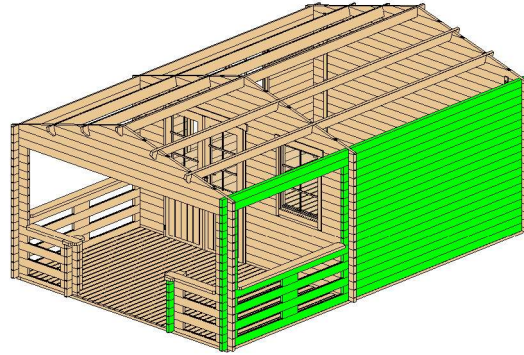

Wall AB			
Mark	Profile	Count	Cut Length
ABLG 1	40x114	6	11 13/16"
ABTL 1	40x57	1	11 13/16"

Wall B			
Mark	Profile	Count	Cut Length
BLG 1	40x114	13	11 13/16"
BLG 2	40x114	3	11 13/16"
BLG 3	40x114	13	141 3/4"
BLG 4	40x114	4	234 1/4"
BLG 5	40x114	1	234 1/4"
BTL 1	40x122	1	234 1/4"

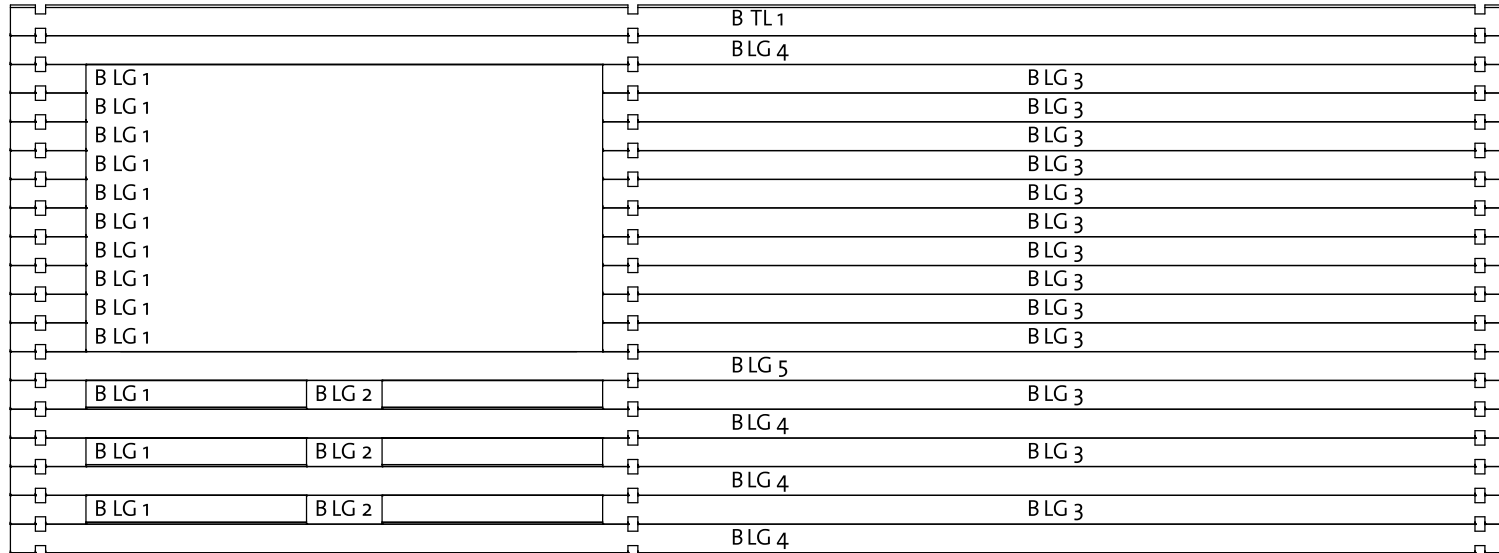

Log Profile Wall B	
Profile	Profile

40x57	
40x114	
40x122	



# Montana 1 9/16" (149 5/8"x226 3/8")

Roof 1

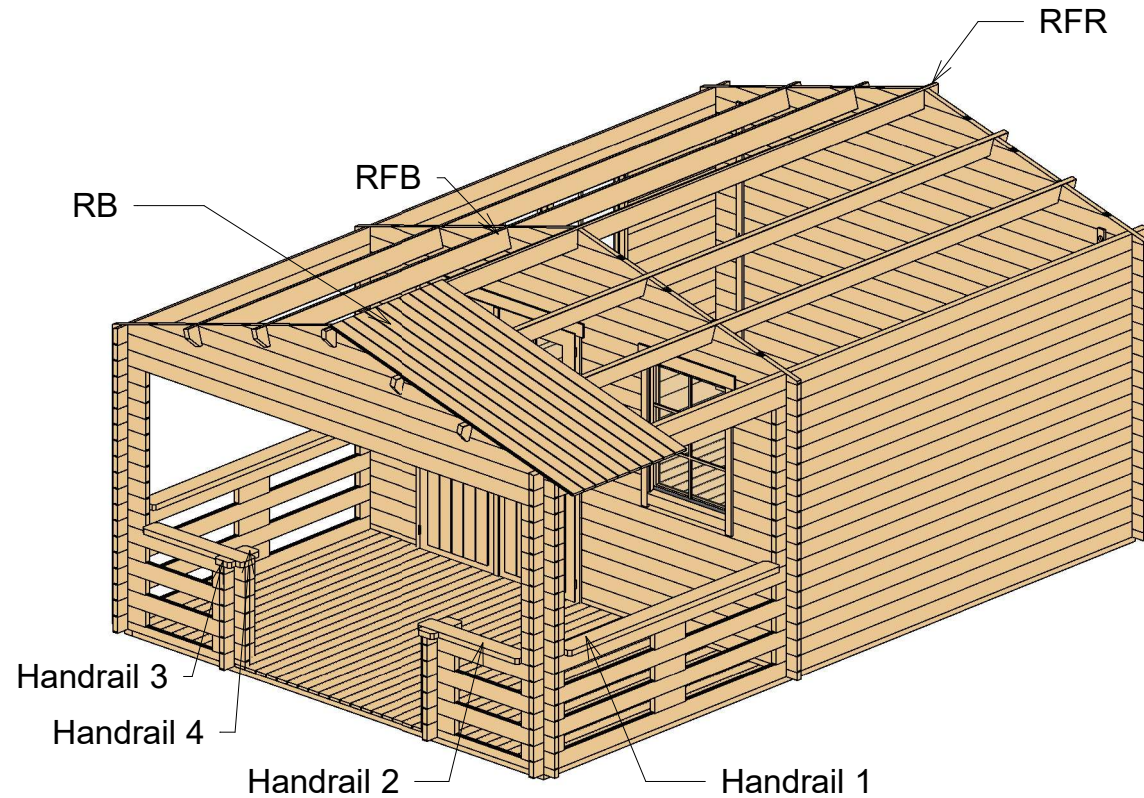

Roof				
Mark	Type	Profile	Count	Length
RFR	Ridge 40x143		1	234 1/4"
RFB	Beam 40x143		4	234 1/4"
RB	RoofBoard 18x110		110	89 3/4"

Type	Profile	Count	Length
Handrail 1	40x143	2	80 11/16"
Handrail 2	40x143	2	35 13/16"
Handrail 3	40x143	2	2 3/8"
Handrail 4	40x143	2	3 15/16"



# Montana 1 9/16" (149 5/8"x226 3/8")

Roof 2

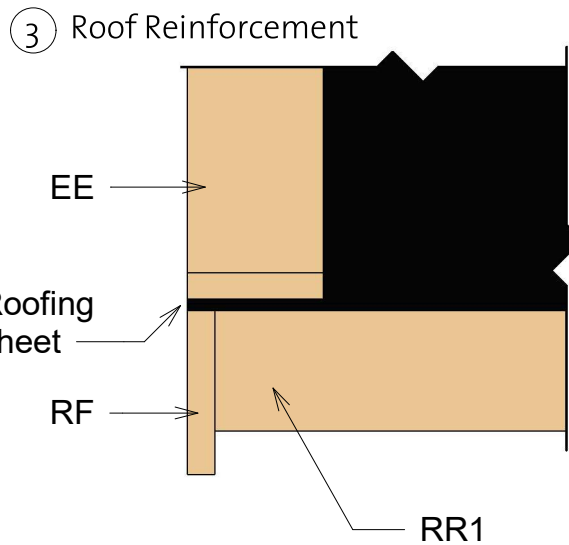
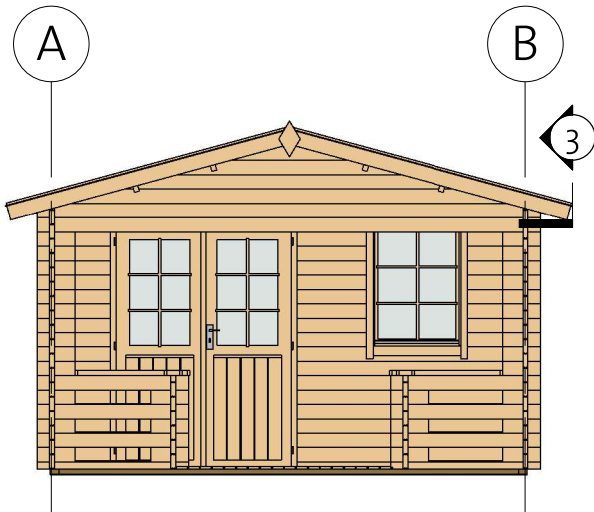
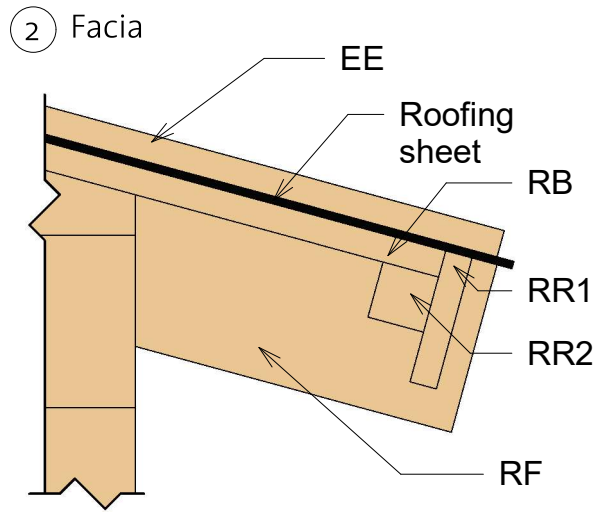
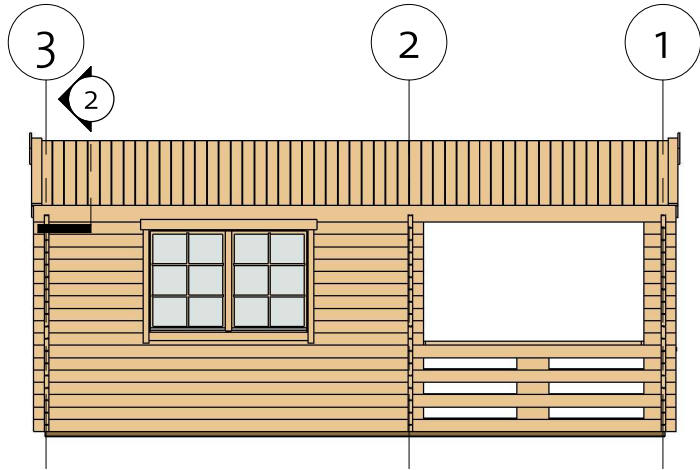

Fascia Schedule				
Mark	Type	Profile	Count	Length
EE	Eave Edging 18x90		4	91 5/16"
RF	Fascia 18x115		4	91 5/16"
RR1	Roof reinforcement 18x90		4	117 1/8"
RR2	Roof reinforcement 38x38		4	117 1/8"

# Montana 1 9/16" (149 5/8"x226 3/8")

Extras

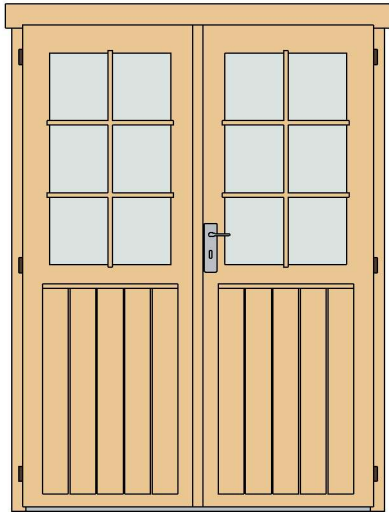

Door Schedule				
Model	Type	Width	Height	Count
CDD1	Classic double door 1	56 1/8"	76 15/16"	1
DCB6	Door crossbar 6	--	--	2
DB	Door beam 1440 mm	40	12	1

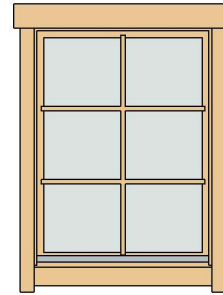

Window Schedule				
Model	Type	Width	Height	Count
CW1L	Classic window 1 left	30 1/8"	39"	1
CDW1	Classic double window 1	60 1/4"	39"	1
WCB6	Window crossbar 6	--	--	3

Fasteners/Extras		
Name	Type	Count

Hitblock	11 13/16"-15 3/4"	
Bolts	M3/8" x 2 3/4"	18
Screws	3/16" x 2 3/4"	35
Screws	1/4" x 5 1/2"	75
Screws	3/16" x 1 9/16"	130
Screws	3/16" x 2"	1000



Type	Count	Lenght
Windboard 18x40	6	86 5/8"



Type	Count
Romb	2

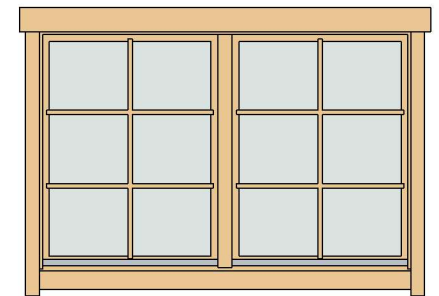



# Montana 1 9/16" (149 5/8"x226 3/8")

## List of all items 1



### Impregnated foundation beams

Mark	Type	Profile	Count	Length
------	------	---------	-------	--------

IFB1	IFB 70x40		2	226"
IFB2	IFB 70x40		12	143 11/16"
IFB3	IFB 70x40		2	19 3/16"

### Floor Schedule





Mark	Type	Profile	Count	Length
------	------	---------	-------	--------

FB	FB 18x110		35	130 9/16"
TB1	TB 21x95		21	90 15/16"
TB2	TB 21x95		18	92 1/2"

BB1	BB 20x40		2	3800
BB2	BB 20x40		2	3400



### Fascia Schedule

Mark	Type	Profile	Count	Length
------	------	---------	-------	--------

EE	Eave Edging 18x90		4	91 5/16"
RF	Facia 18x115		4	91 5/16"
RR1	Roof reinforcement 18x90		4	117 1/8"
RR2	Roof reinforcement 38x38		4	117 1/8"

### Roof

Mark	Type	Profile	Count	Length
------	------	---------	-------	--------

RFR	Ridge 40x143		1	234 1/4"
RFB	Beam 40x143		4	234 1/4"
RB	RoofBoard 18x110		110	89 3/4"

# Montana 1 9/16" (149 5/8"x226 3/8")

## List of all items 2

Wall 1			
Mark	Profile	Count	Cut Length

1BL 1	40X57	2	47 1/4"
1LG 1	40X114	32	11 13/16"
1LG 2*	40X114	1	33"
1LG 3	40X114	4	47 1/4"
1LG 4*	40X114	1	66 1/16"
1LG 5*	40X114	1	96 5/8"
1LG 6*	40X114	1	132 3/16"
1LG 7*	40X114	1	157 1/2"
1LG 8	40X114	2	157 1/2"
1LG 9	40X114	2	47 1/4"

Wall 2			
Mark	Profile	Count	Cut Length



2BL 1	40X57	1	23 5/8"
2BL 2	40X57	1	77 3/16"
2LG 1	40X114	9	23 1/4"
2LG 2	40X114	26	23 5/8"
2LG 3*	40X114	1	33"
2LG 4*	40X114	1	66 1/16"
2LG 5	40X114	8	77 3/16"
2LG 6*	40X114	1	96 5/8"
2LG 7*	40X114	1	132 3/16"
2LG 8*	40X114	1	157 1/2"
2LG 9	40X114	1	157 1/2"

\*Gable-delivered premounted

Wall 3			
Mark	Profile	Count	Cut Length

3BL 1	40X57	1	157 1/2"
3LG 1*	40X114	1	33"
3LG 2*	40X114	1	66 1/16"
3LG 3*	40X114	1	96 5/8"
3LG 4*	40X114	1	132 3/16"
3LG 5*	40X114	1	157 1/2"
3LG 6	40X114	18	157 1/2"

Log Profiles 1	
Profile	Profile

40X57	
40X114	

# Montana 1 9/16" (149 5/8"x226 3/8")

## List of all items 3

Wall A			
Mark	Profile	Count	Cut Length

ALG 1	40X114	13	11 13/16"
ALG 2	40X114	3	11 13/16"
ALG 3	40X114	18	40 9/16"
ALG 4	40X114	4	141 3/4"
ALG 5	40X114	4	234 1/4"
ALG 6	40X114	1	234 1/4"
ATL 1	40X122	1	234 1/4"

Wall B			
Mark	Profile	Count	Cut Length

BLG 1	40X114	13	11 13/16"
BLG 2	40X114	3	11 13/16"
BLG 3	40X114	13	141 3/4"
BLG 4	40X114	4	234 1/4"
BLG 5	40X114	1	234 1/4"
BTL 1	40X122	1	234 1/4"



Wall AA			
Mark	Profile	Count	Cut Length

AALG 1	40X114	6	11 13/16"
AATL 1	40X57	1	11 13/16"

Wall AB			
Mark	Profile	Count	Cut Length

ABLG 1	40X114	6	11 13/16"
ABTL 1	40X57	1	11 13/16"

Log Profiles 2	
Profile	Profile

40X57	
40X114	
40X122	